

infrico.com

 **Infrico**

'23

Válido para todo el catálogo:

Precios válidos salvo error tipográfico o cambio de tarifa /

Etiqueta energética disponible en las fichas técnicas de producto en nuestra web infrico.com /

Fotografías no contractuales /

Características técnicas y constructivas sujetas a variación sin previo aviso /

Los datos técnicos están sujetos a posibles variaciones que serán actualizadas periódicamente en las fichas técnicas del producto, disponibles en la web.

Valid for the entire product guide:

Prices valid except in the case of typographical error or change of price list /

Energy label available in the product data sheets on our website infrico.com /

Non contractual pictures /

We reserve the right to change specifications without prior notice /

The technical data are subject to possible variations that will be updated periodically in the technical data sheets of the product, which are available on the website.

Valable pour tout le catalogue:

Prix valables sauf en cas d'erreur typographique ou de changement de tarif.

Etiquette énergétique disponible dans les fiches produits sur notre site infrico.com /

Photos non contractuelles /

Les caractéristiques techniques et la conception peuvent être sujettes à modifications, sans préavis /

Les données techniques peuvent varier et seront actualisées dans les fiches techniques du produit, disponibles sur le site web.

Infrico S. L.
Mayo 2023

INDEX

4 DELEGACIONES
DELEGATIONS
DÉLÉGATIONS

12 NOVEDADES
NEWS
NOUVEAUTÉS

24 ENFRIADORES
BOTTLE COOLERS
REFROIDISSEURS

52 MESAS
UNDERCOUNTERS
TABLES

96 ARMARIOS
REACH INS
ARMOIRES

134 ABATIDORES
BLAST CHILLERS
& FREEZERS
CELLULES DE
REFROIDISSEMENT

150 INFRICOOOL

174 LÍNEA AMERICANA
AMERICAN LINE
LIGNE AMÉRICAINNE

196 CAVAS & DRY AGING

222 VITRINAS
EXPOSITORAS
DYSPLAY CASES
VITRINES DE
PRÉSENTATION

254 SUPERMARKET

342 MURALES
MULTIDECKS
VITRINES
MURALES

438 VITRINAS DE
HELADERÍA -
PASTELERÍA
PASTRY - GELATO
DISPLAY CASES
VITRINES
PÂTISSIERES

492 MAQUINARIA
HOSTELERÍA
HORECA
EQUIPMENT
NÉGOCE

Delegaciones nacionales / National delegations / Délégations nationales

1 - Oficina Central / Main Office / Usine de fabrication

INFRICO S. L. Ctra. de Aguilar a A-318 por Moriles, Km 15,5 - A-3132
CP 14900 Lucena, Córdoba - España

☎ +34 957 51 30 68

☎ +34 957 59 11 83

✉ info@infrico.com

2 - MADRID Y ZONA CENTRO

Javier López

☎ 91 684 60 96

☎ 682 68 21 25

☎ 91 684 61 06

✉ delegacioncentro@infrico.com

9 - VALENCIA, ALICANTE, CASTELLÓN Y ALBACETE

Victoria Oliver / Elena Oliver

SILVINO OLIVER, S.L.

☎ 963 97 02 45

☎ 605 09 75 40

☎ 963 97 02 46

✉ infricovalencia@silvinooliver.com

3 - CATALUÑA-ANDORRA

Raúl Ballano

ITECNIC, S.L.

☎ 93 562 61 52

☎ 93 562 61 45

✉ info@itecnic.com

10 - BALEARES

Manuel Castro Baños

☎ 628 67 18 97

✉ mcastro@infrico.com

4 - CANARIAS

Carlos Vega

DICAFRI, S.L.

☎ 674 88 30 40

☎ 928 70 10 85

✉ comercial.dicafri@infrico.com

11 - GALICIA

Juan José Espejo Colmenero

☎ 609 85 01 55

✉ escohostel@escohostel.com

5 - SEVILLA, HUELVA Y CÁDIZ

José Manuel Romana

☎ 654 50 98 40

✉ josemanueldibeca@hotmail.com

12 - CASTILLA-LEÓN Y ASTURIAS

Paulino Canga González

☎ 609 66 52 54

☎ 670 59 49 86

✉ paulo@delegadoastur.com

6 - CÓRDOBA, JAÉN, MÁLAGA

Miguel Cantero

☎ 620 29 82 82

✉ miguelcantero@infrico.com

13 - PAÍS VASCO, NAVARRA, LA RIOJA Y CANTABRIA

Mikel Pérez De Viñaspre

☎ 650 25 56 34

✉ mikelperez@infrico.com

7 - GRANADA, ALMERÍA Y MURCIA

Daniel Riquelme Cordero

☎ 659 85 04 15

✉ danielriquelmecordero@hotmail.com

14 - ARAGÓN

Adolfo Bueno

☎ 653 85 70 60

✉ buenozaragoza@gmail.com

8 - EXTREMADURA

Manuel Pérez Guisado

☎ 670 03 23 56

☎ 924 45 61 91

✉ manuel@representacionesmpg.com



**Delegaciones internacionales /
International delegations /
Délégations Internationales**

NORTH AMERICA

Pedro Carvajal

☎ +34 690 23 44 78

✉ pcarvajal@infrico.com

MÉXICO

Francisco Pedroche

Sinergias

☎ +33 3630 4547 / +33 3615 7926

✉ ventas@sinergiasmx.com

INFRICO USA

Gigi Oyola

☎ 1.855.340.4637

✉ sales@infrico.com

REPÚBLICA DOMINICANA

Rafael Podadera

Parlyn International

☎ + 18097594424

✉ rpodadera@parlyninternational.com

COLOMBIA

Fernando Toro López

☎ +57 313 452 1306

✉ ftoro@infrico.com

ECUADOR / PERÚ / BOLIVIA

Giovanni Pedrazzoli

☎ +59 399 118 6962

✉ gpedrazzoli@infrico.com

CHILE

Josué Meléndez

Comercial Maquinet

☎ Tel.: +56 98199 3973

✉ ventas@maquinet.cl

PORTUGAL

Rui Vigo

Unipessoal Lda. Rui Vigo

☎ + 351 915 283 253

☎ + 351 309 955 122

✉ rui.vigo@netcabo.pt

UK / BENELUX

Mark Botwright

☎ +34 679 71 93 26

✉ mark@infrico.com

INFRICO MAROC /

ÁFRICA /

ARABIA SAUDI

Aziz Bouhartan

☎ + 212 661 107 372

☎ + 212 522 207 372

✉ aziz.bouhartan@infrico.com

LATINOAMÉRICA

Efraín Onieva

☎ +34 686 09 12 41

✉ eonieva@infrico.com

NORTH EUROPE**Juan Carlos Fernández**

☎ +34 620 000 938

✉ jcfernandez@infrico.com

CENTRAL / EAST EUROPE**Dragan Cerkez**

☎ +34 608 808 971

✉ dragan@infrico.com

SUIZA / SWITZERLAND**Remzi Alili**

Resan Enfrico Sàrl

☎ + 41 79 589 32 01

☎ + 41 21 671 70 70

✉ resanenfrico@resanenfrico.ch

TURKEY / CENTRAL ASIA**Zeynep Onukar**

☎ + 90 554 712 9784

✉ zeynep@infrico.com

**MIDDLE EAST /
UAE / DUBAI /
INDIA****Sushil Hiranandani**

☎ +971528 496385

✉ middle-east@infrico.com

ASIA**Juan Carlos Fernández**

☎ +34 620 000 938

✉ jcfernandez@infrico.com

SOUTH-EAST ASIA**Roberto Doval**

☎ +34 606 970 357

✉ rdoval@infrico.com

SOUTH AFRICA**Culinary**

☎ +27 (0) 11 701 2200

✉ info@culinary.co.za

Infrico en el Mundo / Infrico Worldwide / Infrico dans le Monde**ASIA - AUSTRALIA - BENELUX - CENTROAMÉRICA - FRANCE - ÁFRICA - PORTUGAL
ARABIA SAUDÍ - USA - CANADÁ - LATINOAMÉRICA - DUBAI - MIDDLE EAST - NORTH EUROPE
REP. DOMINICANA - EAST EUROPE - RUSSIA - SWITZERLAND - UNITED KINGDOM**

Délégations France

infrico.fr 🏠 ZAC des Portes d L'Océane OUEST. 72650 SAINT SATURNIN (FRANCE)

☎ 02 43 42 00 33

📠 02 43 42 28 07

Direction

Miguel Prieto:

☎ 06 44 17 72 17

✉ mprieto@infrico.com

Service Commercial

☎ 02 43 42 00 33

✉ mgd@infrico.com

Service Compatibilité et Facturation

Valerie Simon:

☎ 07 61 98 47 50

☎ 02 43 42 00 33

✉ comptabilite@infrico.com

Service SAV

Stephane Vivet: Pièces détachées

☎ 02 53 49 17 23

✉ pieces@infrico.com

Miguel Burgos: SAV

☎ 02 53 49 17 22

✉ sav@infrico.com

SECTEUR 1

Paris - Île de France

David Simon:

dsimon@infrico.com

Tél: 06 07 23 00 97

SECTEUR 2

Nord-Ouest

Jerome Crespel:

jerome@infrico.com

Tél: 06 08 64 39 76

SECTEUR 3

Nord-Est

Jean Bernard Florine

jbflorine@infrico.com

Tél: 07 86 42 12 11

SECTEUR 4

Sud Est - Monaco

Pierre Tagournet:

pierre@infrico.com

Tél: 06 74 91 73 03

SECTEUR 5

Sud Ouest - Corse

Vincent Lecocq:

vincent@infrico.com

Tél: 07 72 77 49 65

OUTRE MER - 6

La Martinique, Guadeloupe, La Réunion, Mayotte, La Guyane, Nouvelle Calédonie

Sophia Choukri

sophia@infrico.com

Tél: 06 58 04 33 15

Infrico France



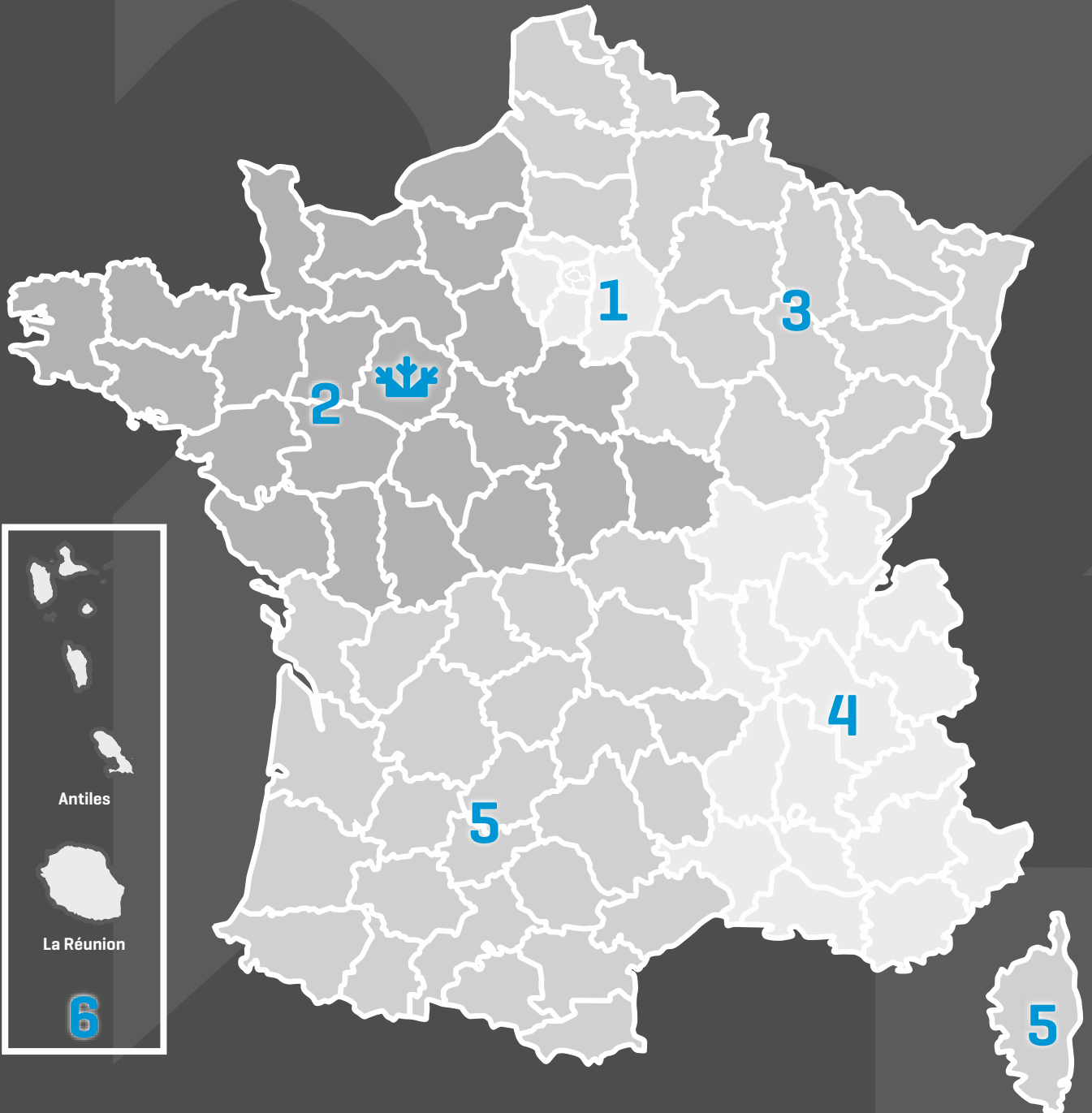

GRUPO Infrico®

 Infrico

 Impafri

 Infrico
Supermarket

 Infrico
medcare

 by
YOU

 friBuffet



INFRICO nace en 1986 con un objetivo claro: generar las mejores soluciones de refrigeración adaptadas a las necesidades específicas de cada cliente. **Vanguardia tecnológica, calidad certificada y la excelencia de sus productos son las garantías** que avalan su compromiso de innovación y que la han posicionado como líderes absolutos en el sector del equipamiento del frío comercial.

La empresa ofrece una muy amplia gama de maquinaria que abarca todo lo relacionado con el frío para el sector **HORECA**, panadería, pastelería, heladería, catering y también **Supermarket**, mediante su línea específica,

a través del frío. También el sector biomédico y de laboratorio con su prestigiosa línea **Infrico Medcare**.

Con clientes en todo el mundo y una gran cuota de mercado nacional, la compañía, que se encuentra en un continuo proceso de crecimiento y expansión, cuenta en la actualidad con más de quinientos empleados repartidos en 13 delegaciones en España y 16 en el extranjero. Además, en una firme apuesta por la estabilidad y el bienestar social, más del 90% de los trabajadores son empleados fijos.

Infrico posee el Certificado de **Origen Español Certificado** (O.E.C.) que acredita que

sus productos son fabricados en España, convirtiéndose así en la primera compañía del sector que logra este sello en nuestro país, tras superar con éxito su exhaustivo proceso de auditoría.

Sus centros de producción ubicados en Lucena, en la provincia de Córdoba, son unas de las instalaciones industriales más modernas de España. Tres plantas, Infrico, Infrico Supermarket e Impafri, que cuentan con una superficie total de **160.000 metros cuadrados** destinados a producción, actividades logísticas y oficinas.



INFRICO was born in 1986 with a clear objective: to generate the best cooling solutions adapted to the specific needs of each client. **Technological vanguard, certified quality and the excellence of its products are the guarantees** to support its commitment to innovation and that have positioned it as absolute leaders in the commercial refrigeration equipment. The company offers a very wide range of machinery that covers everything related to cold for the **HORECA** sector, bakery, pastry, ice cream, catering and also **Supermarket**, through its specific line,

thanks to cold. Also, the biomedical and laboratory sector, with its prestigious **Infrico Medicare** line.

It has customers around the world and a large share of the national market, the company, which is in a continuous process of growth and expansion, currently has more than five hundred employees spread across 13 delegations in Spain and 16 abroad. In addition, in a firm commitment to stability and social welfare, more than 90% of workers are permanent employees.

The company has **Spanish Origin Certificate**

[S.O.C.] that certifies that its products are manufactured in Spain, thus becoming the first company in this sector in Spain to achieve this seal after successfully completing its exhaustive audit process.

The Production Centers are located in Lucena, in the province of Cordoba, they are one of the most modern industrial facilities in Spain. Three plants that have a total area of **160.000 square meters** for production, logistics activities and offices.



INFRICO est un fabricant espagnol leader dans la production d'équipement de réfrigération commerciale. **Technologie de pointe et qualité certifiée sont les garanties** sur lesquelles est fondé notre engagement d'innovation: élaborer les meilleures idées et solutions pour chacun de nos clients.

L'entreprise se situe parmi les entreprises leaders du secteur, avec une position très avantageuse par rapport à ses concurrents quant au volume de marché et à sa présence sur le territoire français.

Avec 13 délégations sur le territoire espagnol et 16 à l'étranger, Infrico répond aux be-

soins de ses clients de manière proche et en temps opportun, avec un système de production flexible et efficace.

Infrico dispose de trois centres de production, Infrico, Impafri et Infrico supermarket avec une superficie totale de **160.000 m2 dont 60.000 m2** dédiés à la fabrication.



NOVED



Garantía: 2 años
Warranty: 2 years
Garantie: 2 ans

ENFRIADORES
BOTTLE COOLERS
REFROIDISSEURS



ERV 25 II SH



SCP501/B

 Bebida en estado
liquido
 sin congelar.

 Temperatura
bajo cero
 en menos de 2h.

 Tecnología
aplicable a
 todo tipo
 de **bebidas**

MESAS
UNDERCOUNTERS
TABLES

MR 1620 H



MR 2190 H

Control electrónico de
 Temperatura y Humedad
 Electronic Temperature and
 Humidity control
 Contrôle électronique de la
 Température et de l'humidité



SUPERMARKET

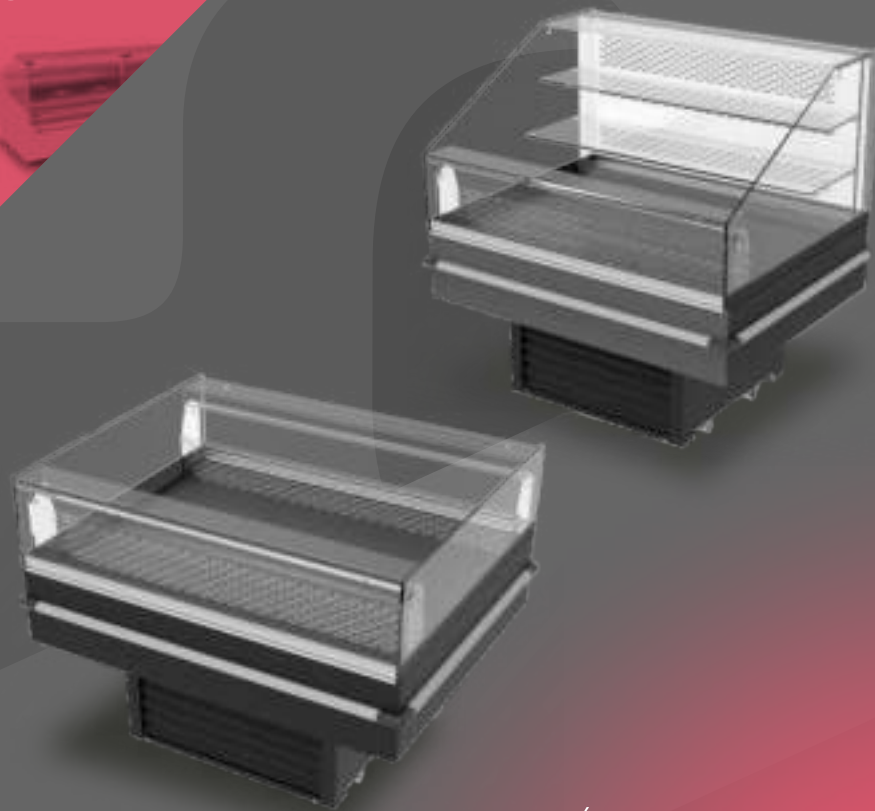

VISION SVS/VVS

MURALES
MULTIDECKS
VITRINES
MURALES



MS12CPBA

MS9BA



MN37DR

**ARMARIOS
REACH INS
ARMOIRES**



AN401/901 BT PAST

FC900BT/CR

RIC1P/2P/BT1P

**CAVAS &
DRY AGING**



VC1400/2010 MDA/B

AC280MDAB

**VITRINAS DE
HELADERÍA -
PASTELERÍA
PASTRY - GELATO
DISPLAY CASES
VITRINES
PÂTISSIÈRES**



VMG12B



VCB Restyling

**MAQUINARIA
HOSTELERÍA
HORECA
EQUIPMENT
NÉGOCE**



ICE Pebbles

Salamandra Ultra-Rapida



PRO 21 (-60°C)



HDC 100 L



15 Delegaciones
15 Delegations
15 Délégations



18 Delegaciones
18 Delegations
18 Délégations



Más de 700 trabajadores
More than 700 employees
Plus de 700 employés



Certificado Origen Español
Spanish Origin Certificate
Certificat d'Origine Espagnol



160.000 m² dedicados a la fabricación de equipos de refrigeración comercial de última generación

160.000 m² dedicated to the manufacture of commercial refrigeration equipment of last generation

160.000 m² dédiés à la fabrication de produits de réfrigération commerciale de pointe



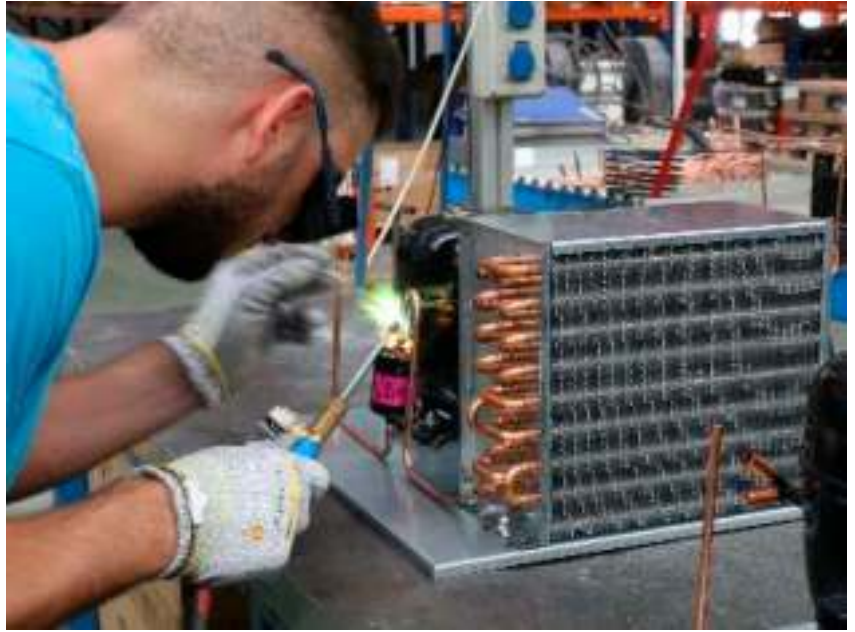

Colaboramos / We collaborate / En collaboration avec



Participamos en / We participate in / Nous sommes présents



Responsabilidad Social Corporativa [RSC]
Corporate Social Responsibility [CSR]
Responsabilité Sociale des Entreprises [RSC]

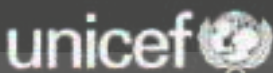

Patrocinador / Sponsor
Club Deportivo Lucena





Ferias y Exhibiciones / Fairs and Exhibitions / Salons et Expositions



Infrico está presente en las principales ferias internacionales del sector, donde año tras año presenta las novedades, diseños y avances tecnológicos de sus productos.

Infrico is present at the main international fairs of the sector, where year after year we present the novelties, designs and technological advances of our products.

Infrico est présent dans les principaux salons du secteur, durant lesquels années après années, sont présentées les nouveautés et dernières avancées techniques de ses produits.



SIRHA LYON 2023



NAFEM ORLANDO 2023



ABASTUR MEXICO 2022



EXPOACAIRE COLOMBIA 2022



NRA CHICAGO 2022



GULF HOST DUBAI 2022

1. Enfriadores

Bottle coolers / Refroidisseurs de bouteilles



The logo for Infrico, featuring a stylized crown icon on the left and the word "Infrico" in a bold, sans-serif font to its right. The crown icon has three main points, with the central one being taller and topped with a vertical spike. The word "Infrico" is rendered in a clean, modern typeface with a slight shadow effect.

Infrico

1. Enfriadores

Bottle coolers / Refroidisseurs de bouteilles



+Info: www.infrico.com



1. Enfriadores

Bottle coolers / Refroidisseurs de bouteilles

Iluminación / Lighting / Éclairage

Incorporación de iluminación LED, llegando a reducir el consumo energético entre un 80% y 90%, respecto a una bombilla tradicional. RGB opcional.

LED lighting incorporated, reducing energetic consumption between 80% and 90% respect to a traditional light bulb. RGB optional.

Éclairage LED, réduisant la consommation énergétique entre 80% et 90%, par rapport à une ampoule traditionnelle. RGB optionnel.



Doble acristalamiento templado, bajo emisor con carga de Argón [4-27-4].

Double tempered glass, low-e with argon charge [4-27-4].

Triple vitrage et verre trempé [4-12-3-12-4].





Cabezal iluminado
opcional.

Option Canopy.

Canopy en option.



Controlador digital táctil e
intuitivo IP 65.

Digital control easy and
intuitive-touch screen IP65
protection.

Contrôleur digital tactile e
intuitif IP 65.



1. Enfriadores

Bottle coolers / Refroidisseurs de bouteilles

Serie / Series / Série

EFP	Enfriador de botellas Chest bottle cooler / Refroidisseur de bouteilles	32 - 33
------------	---	----------------

Serie / Series / Série

EB	Enfriador de botellas Chest bottle cooler / Refroidisseur de bouteilles	34 - 35
EBC	Enfriador de botellas con cajones Chest bottle cooler with drawers / Refroidisseur de bouteilles avec tiroirs	

Serie / Series / Série

ERV	Expositor refrigerado horizontal altura 850 mm. Back-Bar 850 mm. height / Arrière bar horizontal hauteur 850 mm.	36 - 37
	Expositor refrigerado horizontal altura 920 mm. Back-Bar 920 mm. height / Arrière bar horizontal hauteur 920 mm.	38 - 39

Serie / Series / Série

ERV INOX	Expositor refrigerado horizontal en inox altura 920 mm. Stainless steel Back-Bar 920 mm. height / Arrière bar horizontal inox hauteur 920 mm.	40 - 41
-----------------	---	----------------

Serie / Series / Série

ERV	Expositor refrigerado vertical 1820mm Vertical glass door merchandiser 1820mm/ Armoire verticale d'exposition réfrigérée 1820mm	42 - 43
------------	--	----------------

Serie / Series / Série

ERC	Expositor refrigerado puertas correderas Sliding glass door merchandiser / Armoire d'exposition réfrigérée avec portes coulissantes	42 - 43
------------	---	----------------

Serie / Series / Série

NEW MINIMARKET	Expositor refrigeración y congelación Glass door merchandiser refrigeration and freezer Armoire d'exposition réfrigération et congélation	44 - 45
-----------------------	--	----------------

Serie / Series / Série

NEC	Expositor refrigeración y congelación Glass door merchandiser refrigeration and freezer / Armoire d'exposition réfrigération et congélation	46 - 47
------------	---	----------------

Serie / Series / Série

NEW SPC	Enfriador de botellas Supercooler Chest bottle cooler Supercooler / Réfrigidisseur de bouteilles Supercooler	48 - 49
----------------	--	----------------

Serie / Series / Série

ESC	Escarchador de copas Glass froster counter / Mini congélateur vertical	50 - 51
------------	--	----------------

Serie / Series / Série

TA	Tanque enfriador de agua Water tank cooler / Refroidisseur d'eau	50 - 51
-----------	--	----------------

Serie / Series / Série

EFP







EFP 1000 EG EFP 1500 EG EFP 2000 EG EFP 1000 II EFP 1500 II EFP 2000 II

REFRIGERACIÓN / REFRIGERATOR / POSITIF

Serie / Series / Série

**EB
EBC**















EB 1000 II EB 1500 II EB 2000 II EB 2500 II EBC 1000 II EBC 1500 II EBC 2000 II

REFRIGERACIÓN / REFRIGERATOR / POSITIF







Serie / Series / Série

ERV

ERV 15 SH ERV 25 SH ERV 35 SH ERV 15 II SH ERV 25 II SH ERV 35 II SH

REFRIGERACIÓN / REFRIGERATOR / POSITIF / 850mm ↓















ERV 15 PP ERV 25 PP ERV 35 PP ERV 15 ERV 25 ERV 35 ERV 25 C

REFRIGERACIÓN / REFRIGERATOR / POSITIF / 920mm ↓

Serie / Series / Série

**ERV INOX
ERV PP INOX**

ERV 15 II ERV 25 II ERV 35 II ERV 15 PP II ERV 25 PP II ERV 35 PP II

REFRIGERACIÓN / REFRIGERATOR / POSITIF / 920mm ↓

Serie / Series / Série

ERV



ERV 53 ERV 83

REFRIGERACIÓN / REFRIGERATOR / POSITIF

Serie / Series / Série

ERC







ERC 15 ERC 36 B ERC 100 ERC 130 ERC 200

REFRIGERACIÓN / REFRIGERATOR / POSITIF

Serie / Series / Série

MINIMARKET





ERC 130 PH ERC 200 PH ERC 130 PH BT ERC 200 PH BT

REFRIGERACIÓN / REFRIGERATOR / POSITIF | CONGELACIÓN / FREEZER / NÉGATIVE

Serie / Series / Série

NEC







NEC501RV NEC1002RV NEC401FS NEC501FV NEC1002FV

REFRIGERACIÓN / REFRIGERATOR / POSITIF | CONGELACIÓN / FREEZER / NÉGATIVE

Serie / Series / Série

**SPC
SUPERCooler**



SPC501 SPC501B

Serie / Series / Série

**ESC
TA**











ESC 50 ESC 50 CR TA 100 II TA 180 II

CONGEL/FREEZ/NÉGAT | REFRIG/REFRIG/POSITIF

Refrigerador de botellas / Chest bottle cooler / Refroidisseur de bouteilles

MODELO MODELE MODÈLE						
	EFP 1000 EG	EFP 1500 EG	EFP 2000 EG	EFP 1000 II	EFP 1500 II	EFP 2000 II
Precio Price Prix						
Medidas Measures [mm] Mesures	1004 x 550 x 880 mm.	1479 x 550 x 880 mm.	1954 x 550 x 880 mm.	1004 x 550 x 880 mm.	1479 x 550 x 880 mm.	1954 x 550 x 880 mm.
Temperatura Temperature Température	+3°C/+6°C					
Clase Climática Climatic class Classe climatique	4 / 38°C					
Tensión/Frecuencia Electrical data Tension électrique	230V/1ph/50Hz					
Controlador Controller Régulateur	Termostático / Thermostatic / Thermostatique					
Material Material [EXT/INT] Matériel	Exterior plastificado blanco / Encimera INOX AISI 304 Exterior prepainted / INOX AISI 304 worktop Extérieur plastifié blanc / Dessus INOX AISI 304			Encimera INOX AISI 304 / Interior-Exterior AISI 430 INOX AISI 304 Worktop / AISI 430 Interior-Exterior Dessus INOX AISI 304 / Intérieur-Extérieur AISI 430		
Espesor Thickness Épaisseur	40					
Aislamiento Isolation Isolation	40kg/m ³ / Free CFC's / Zero ODP-GWP					
Capacidad Capacity Capacité	200	305	415	200	305	415
Puertas Doors Portes	2	3	4	2	3	4
Nº separadores Nº dividers Nº séparateurs	1	2	3	1	2	3
Sistema de frío Cooling System Système de froid	Condensación Forzado / Forced air condensation / Condensation Ventilé Evaporador estático / Static evaporator / Évaporateur statique					
Desescarche Defrost Dégivrage	-					
Expansión Expansion Expansion	Capilar / Capillary / Capillaire					
Potencia Power Puissance	122	180	180	122	180	180
Potencia fríg. Cooling capacity Puissance Frig.	169	370	370	169	370	370
Consumo Consumption Consommation	-					
Clase energética Energy class Classe Énerg.	-					
Refrigerante Refrigerant Gaz	R-600a	R-290		R-600a	R-290	
Opcional Optional Options	Separador / Divider / Séparateur [504X26] 115V/1 ph/60 Hz 230V/1 ph/60 Hz					



Serie / Series / Série **EFP**

+Info: www.infrico.com



EFP 2000 EG









EFP 1000 II



EFP 1500 EG

Refrigerador de botellas / Chest bottle cooler / Refridisseur de bouteilles (EB)

Refrigerador de botellas con cajones / Chest bottle cooler with drawers / Refridisseur de bouteilles avec tiroirs (EBC)

MODELO MODELE MODÈLE							
	EB 1000 II	EB 1500 II	EB 2000 II	EB 2500 II	EBC 1000 II	EBC 1500 II	EBC 2000 II
Precio Price Prix							
Medidas Measures [mm] Mesures	1004 x 550 x 865 mm.	1479 x 550 x 865 mm.	1954 x 550 x 865 mm.	2429 x 550 x 865 mm.	1004 x 550 x 865 mm.	1479 x 550 x 865 mm.	1954 x 550 x 865 mm.
Temperatura Temperature Température	+3°C/+6°C						
Clase Climática Climatic class Classe climatique	4 / 38°C						
Tensión/Frecuencia Electrical data Tension électrique	230V/1ph/50Hz						
Controlador Controller Régulateur	-						
Material Matériel [EXT/INT]	Encimera INOX AISI 304 / Interior-Exterior AISI 430 INOX AISI 304 Worktop / AISI 430 Interior-Exterior Dessus INOX AISI 304 / Interior-Extérieur AISI 430						
Espesor Thickness Épaisseur	40						
Aislamiento Isolation Isolation	40kg/m ³ / Free CFC's / Zero ODP-GWP						
Capacidad Capacity Capacité	265	445	620	800	265	445	620
Puertas Doors Portes	2	3	4	5	2	3	4
Nº Separadores Nº Dividers Nº Séparateur	1	2	3	4	1	2	3
Sistema de frío Cooling System Système de froid	Forzado / Forced air / Ventilé Evaporador estático / Static evaporator / Évaporateur statique						
Desescarche Defrost Dégivrage	-						
Expansión Expansion Expansion	Capilar / Capillary / Capillaire						
Potencia Power Puissance	122	180	180	355	122	180	180
Potencia fríg. Cooling capacity Puissance Frig. [W A -10°C]	169	370	370	690	169	343	343
Consumo Consumption Consommation [kWh/ 24h]	-						
Clase energética Energy class Classe Énerg.	-						
Refrigerante Refrigerant Gaz	R-600a	R-290			R-600a	R-290	
Opcional Optional Options	Separador / Divider / Séparateur [504X32] 115V/1 ph/60 Hz 230V/1 ph/60 Hz				-		

Serie / Series / Série **EB / EBC**

+Info: www.infrico.com







EBC 2000 II



EB 1000 II

EBC 1000 II

Expositor refrigerado horizontal altura 850mm / Back-Bar 850mm height / Arrière bar horizontal hauteur 850mm

MODELO MODELE MODÈLE						
	ERV 15 SH	ERV 25 SH	ERV 35 SH	ERV 15 II SH	ERV 25 II SH	ERV 35 II SH
Precio Price Prix						
Medidas Measures [mm] Mesures	600 x 510 x 850 mm.	900 x 510 x 850 mm.	1350 x 510 x 850 mm.	600 x 510 x 850 mm.	900 x 510 x 850 mm.	1350 x 510 x 850 mm.
Temperatura Temperature Température	+4°C/+12°C					
Clase Climática Climatic class Classe climatique	4 / 38°C					
Tensión/Frecuencia Electrical data Tension électrique	230V/1ph/50Hz					
Controlador Controller Régulateur	Digital / Digital / Électronique IP65					
Material Matériel [EXT/INT]	Exterior acero plastificado negro / Interior acero plastificado gris Black plastic coated steel exterior / Grey plastic coated steel interior Extérieur acier plastifié noir / Intérieur acier plastifié gris			Interior plastificado gris / Exterior INOX AISI 430 Interior prepainted grey / INOX AISI 430 Exterior Intérieur plastifié gris / Extérieur INOX AISI 430		
Espesor Thickness Épaisseur	30					
Aislamiento Isolation Isolation	40kg/m ³ / Free CFC's / Zero ODP-GWP					
Capacidad Capacity Capacité	124	193	296	124	193	296
Puertas Doors Portes	1	2	3	1	2	3
Nº parrillas J. guías Nº shelves / Slides Nº de grilles / Glissière	2	2	2	2	2	2
Sistema de frío Cooling System Système de froid	Forzado / Forced air / Ventilé					
Desescarche Defrost Dégivrage	Automático / Automatic / Automatique					
Expansión Expansion Expansion	Capilar / Capillary / Capillaire					
Potencia Power Puissance	250	320	259	250	320	259
Potencia fríg. Cooling capacity Puissance Frig.	370					
Consumo Consumption Consommation	-					
Clase energética Energy class Classe Énerg.	-					
Refrigerante Refrigerant Gaz	R-290					
Opcional Optional Options	Iluminación Led RGB con cambio de color [por puerta] / Led lighting RGB change of colour [per door] / LED RGB avec changement de couleur [par porte] 115V/1 ph/60 Hz 230V/1 ph/60 Hz					



Serie / Series / Série **ERV**

+Info: www.infrico.com



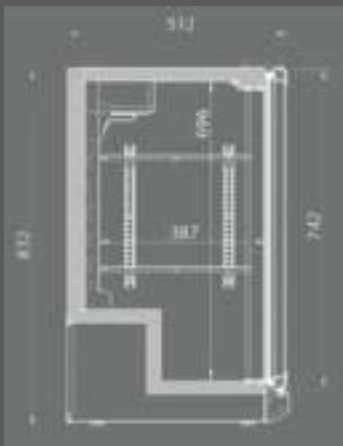



ERV 25 SH



ERV 35 II SH

Expositor refrigerado horizontal altura 920mm / Back-Bar 920mm height / Arrière bar horizontal hauteur 920mm

Puertas correderas
Sliding doors
Portes coulissantes

MODELO MODELE MODÈLE							
	ERV 15 PP	ERV 25 PP	ERV 35 PP	ERV 15	ERV 25	ERV 35	ERV 25 C
Precio Price Prix							
Medidas Measures [mm] Mesures	600 x 510 x 920 mm.	900 x 510 x 920 mm.	1350 x 510 x 920 mm.	600 x 510 x 920 mm.	900 x 510 x 920 mm.	1350 x 510 x 920 mm.	900 x 510 x 920 mm.
Temperatura Temperature Température	+4°C/+8°C			+4°C/+12°C			
Clase Climática Climatic class Classe climatique	4 / 38°C						
Tensión/Frecuencia Electrical data Tension électrique	230V/1ph/50Hz						
Controlador Controller Régulateur	Digital / Digital / Électronique IP65						
Material Material [EXT/INT] Matériel	Exterior acero plastificado negro / Interior acero plastificado gris Black plastic coated steel exterior / Grey plastic coated steel interior Extérieur acier plastifié noir / Intérieur acier plastifié gris						
Espesor Thickness Épaisseur	30						
Aislamiento Isolation Isolation	40kg/m ³ / Free CFC's / Zero ODP-GWP						
Capacidad Capacity Capacité	140	220	330	140	220	330	220
Puertas Doors Portes	1	2	3	1	2	3	2
N° parrillas / Guías N° shelves / Slides N° de grilles / Glissière	2						
Sistema de frío Cooling System Système de froid	Forzado / Forced air / Ventilé						
Desescarche Defrost Dégivrage	Automático / Automatic / Automatique						
Expansión Expansion Expansion	Capilar / Capillary / Capillaire						
Potencia Power Puissance	250	320	325	250	320	325	320
Potencia frig. Cooling capacity Puissance Frig.	370						
Consumo Consumption Consommation	-						
Clase energética Energy class Classe Énerg.	-						
Refrigerante Refrigerant Gaz	R-290						
Opcional Optional Options	Iluminación Led RGB con cambio de color (por puerta) / Led lighting RGB change of colour (per door) / LED RGB avec changement de couleur (par porte) Parrilla / Wire shelf / Grille ERV15 (502X27) Parrilla / Wire shelf / Grille ERV25 (502X28) Parrilla / Wire shelf / Grille ERV35 (502X31) 115V/1 ph/60 Hz 230V/1 ph/60 Hz						

Serie / Series / Série **ERV**

+Info: www.infrico.com

ERV 25 PP



ERV 15





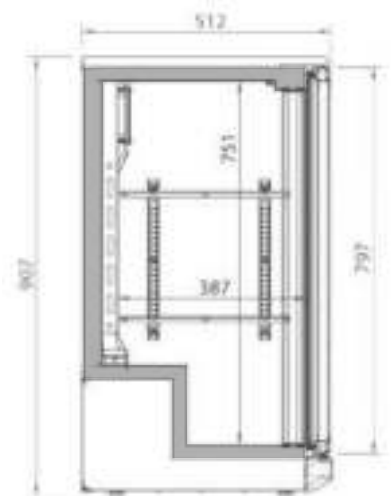



ERV 25

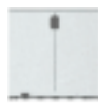

Expositor refrigerado horizontal altura 920mm / Back-Bar 920mm height / Arrière bar horizontal hauteur 920mm

REFRIGERACIÓN / REFRIGERATOR / POSITIF / 920mm ↓

MODELO MODELE MODÈLE						
Precio Price Prix						
Medidas Measures [mm] Mesures	600 x 510 x 920 mm.	900 x 510 x 920 mm.	1350 x 510 x 920 mm.	600 x 510 x 920 mm.	900 x 510 x 920 mm.	1350 x 510 x 920 mm.
Temperatura Temperature Température	+4°C/+12°C					
Clase Climática Climatic class Classe climatique	4 / 38°C					
Tensión/Frecuencia Electrical data Tension électrique	230V/1ph/50Hz					
Controlador Controller Régulateur	Digital / Digital / Électronique IP65					
Material Material [EXT/INT] Matériau	Interior plastificado gris / Exterior INOX AISI 430 Interior prepainted / INOX AISI 430 Exterior Intérieur plastifié gris / Extérieur INOX AISI 430					
Espesor Thickness Épaisseur	30					
Aislamiento Isolation Isolation	40kg/m ³ / Free CFC's / Zero ODP-GWP					
Capacidad Capacity Capacité	140	220	330	140	220	330
Puertas Doors Portes	1	2	3	1	2	3
Nº parrillas / Guías Nº shelves / Slides Nº de grilles / Glissière	2					
Sistema de frío Cooling System Système de froid	Forzado / Forced air / Ventilé					
Desescarche Defrost Dégivrage	Automático / Automatic / Automatique					
Expansión Expansion Expansion	Capilar / Capillary / Capillaire					
Potencia Power Puissance	250	320	325	250	320	325
Potencia frig. Cooling capacity Puissance Frig.	370					
Consumo Consumption Consommation	-					
Clase energética Energy class Classe Énerg.	-					
Refrigerante Refrigerant Gaz	R-290					
Opcional Optional Options	Iluminación Led RGB con cambio de color [por puerta] / Led lighting RGB change of colour [per door] / LED RGB avec changement de couleur [par porte] Parrilla / Wire shelf / Grille ERV15 (502X27) Parrilla / Wire shelf / Grille ERV25 (502X28) Parrilla / Wire shelf / Grille ERV35 (502X31) 115V/1 ph/60 Hz 230V/1 ph/60 Hz					

NEW



Series / Série **ERV INOX / ERV PP**

+Info: www.infrico.com

ERV 25 PP II



ERV 35 II

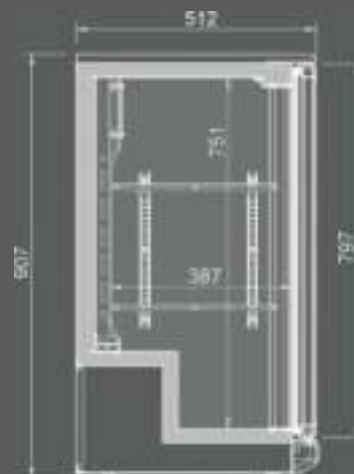

Expositor refrigerado vertical / Glass door merchandiser / Armoire d'exposition réfrig. verticale

Expositor refrigerado vertical / Glass door merchandiser / Armoire d'exposition réfrig. verticale

REFRIGERACIÓN / REFRIGERATOR / POSITIF

MODELO
MODELE
MODÈLE



ERV 53



ERV 83



ERC 36 B



ERC 100



ERC 130



ERC 200

Precio Price Prix									
Medidas Measures [mm] Mesures	600 x 510 x 1820 mm.	900 x 510 x 1820 mm.	620 x 595 x 1870 mm.	1385 x 704 x 2005 mm.	1385 x 804 x 2005 mm.	2081 x 804 x 2005 mm.			
Temperatura Temperature Température	+4°C/+12°C			+4°C/+8°C					
Clase Climática Climatic class Classe climatique	4 / 38°C								
Tensión/Frecuencia Electrical data Tension électrique	230V/1ph/50Hz								
Controlador Controller Régulateur	Digital / Digital / Électronique IP65								
Material Material [EXT/INT] Matériel	Ext. acero plastif. negro / Int. acero plastificado gris Black plastic coated steel ext. / Grey plastic coated steel int. Ext. acier plastifié noir / Int. acier plastifié gris			Ext/Int acero plastificado blanco White plastic coated steel exterior/interior Extérieur/Intérieur acier plastifié blanc					
Espesor Thickness Épaisseur	30			50					
Aislamiento Isolation Isolation	40kg/m ³ / Free CFC's / Zero ODP-GWP								
Capacidad Capacity Capacité	280	435	355	1110	1310	2030			
Puertas Doors Portes	1	2	1	2		3			
Nº parrillas / Guías Nº shelves / Slides Nº de grilles / Glissière	5			4					
Sistema de frío Cooling System Système de froid	Ventilado / Forced air / Ventilé								
Desescarche Defrost Dégivrage	Parada de compresor / Compressor off / Arrêt du compresseur								
Expansión Expansion Expansion	Capilar / Capillary / Capillaire					Válvula termostática / Expansion valve / Détendeur thermostatique			
Potencia Power Puissance	190	443	400	795	787	1111			
Potencia fríg. Cooling capacity Puissance Frig.	370	690	370	950	1296	1440			
Consumo Consumption Consommation	1,67	3,39	-	5,8	6,8	9,2			
Clase energética Energy class Classe Énerg.	A		B		-		C		
Refrigerante Refrigerant Gaz	R-290								
Opcional Optional Options	Iluminación Led RGB con cambio de color [por puerta] / Led lighting RGB change of colour [per door] / LED RGB avec changement de couleur [par porte]		Iluminación Led RGB con cambio de color [por puerta] / Led lighting RGB change of colour [per door] / LED RGB avec changement de couleur [par porte]						
	Parrilla / Wire shelf / Grille ERV53 [502X27]		115V/1 ph/60 Hz						
Parrilla / Wire shelf / Grille ERV83 [502X28]		230V/1 ph/60 Hz							
Cabezal iluminado / Illuminated canopy / Bandeau lumineux		-					Interior - Exterior / Interior - Exterior / Intérieur - extérieur Negro / Black / Noir RAL 9017		

Serie / Series / Série **ERV**
Serie / Series / Série **ERC**

+Info: www.infrico.com

Cabezal iluminado
Canopy illuminated
Bandeau lumineux



ERC 200

ERC 130 / 200



ERC 100

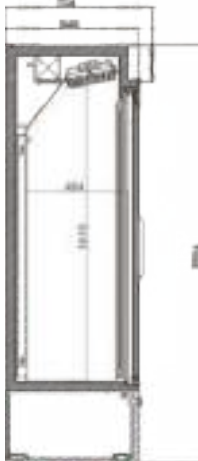

ERV 83

Video del producto
Product Video
Vidéo du produit



Infrico Youtube

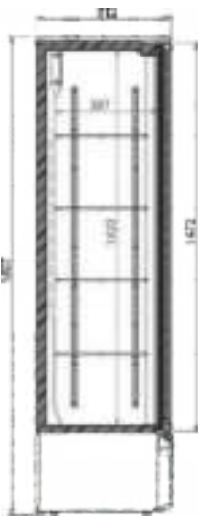

ERC 36 B

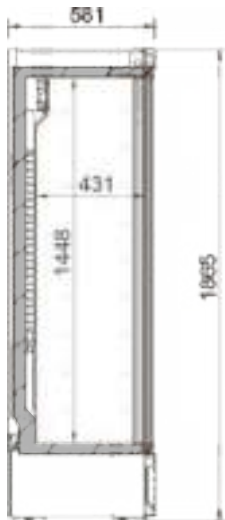

Expositor refrigerado vertical / Glass door merchandiser / Armoire d'exposition réfrig. verticale

NEW



ERC 130 PH

NEW



ERC 130 PH BT

NEW



ERC 200 PH

NEW



ERC 200 PH BT

MODELO MODELE MODÈLE	ERC 130 PH	ERC 130 PH BT	ERC 200 PH	ERC 200 PH BT
Precio Price Prix				
Medidas Measures [mm] Mesures	1384 x 842 x 2003 mm.		2081 x 842 x 2003 mm.	
Temperatura Temperature Température [°C]	+4°C/+8°C	-18°C	+4°C/+8°C	-18°C
Clase Climática Climatic class Classe climatique [°C]	4 / 38°C			
Tensión/Frecuencia Electrical data Tension électrique	230V/1ph/50Hz			
Controlador Controller Régulateur	Digital / Digital / Électronique IP65			
Material Material [EXT/INT] Matériel	Int acero plastificado blanco / Ext acero plastificado negro White plastic coated steel interior / Black plastic coated steel exterior Intérieur acier plastifié blanc / Extérieur acier plastifié noir			
Espesor Thickness Épaisseur [mm]	55		55	
Aislamiento Isolation Isolation [mm]	40kg/m ³ / Free CFC's / Zero ODP-GWP			
Capacidad Capacity Capacité [L]	1310		2030	
Puertas Doors Portes	2		3	
Nº estantes Nº shelves Nº d'étagères	4		8	
Sistema de frío Cooling System Système de froid	Ventilado / Forced air / Ventilé			
Desescarche Defrost Dégivrage	Parada compresor / Compresor off / Arrêt compresseur.	Gas caliente / Hot gas / Gaz chaud	Parada compresor / Compresor off / Arrêt compresseur.	Gas caliente / Hot gas / Gaz chaud
Expansión Expansion Expansion	Capilar / Capillary / Capillaire		Válvula termostática / Expansion valve / Détendeur thermostatique	
Potencia Power Puissance [W]	844	890	1123	1960
Potencia frig. Cooling capacity Puissance Frig. [W A -10°C]	1296	907	1559	1484
Consumo Consumption Consommation [kWh/ 24h]	6,8	16,6	9,2	28
Clase energética Energy class Classe Énerg.	C	D	C	D
Refrigerante Refrigerant Gaz	R-290			
Opcional Optional Options	Iluminación Led RGB con cambio de color (por puerta) / Led lighting RGB change of colour (per door) / LED RGB avec changement de couleur (par porte) Kit Portaprecios ERC 100/130 [KPPER13] Kit Portaprecios ERC200 [KPPER20] 115V/1 ph/60 Hz 230V/1 ph/60 Hz Interior - Exterior / Interior - Exterior / Intérieur - extérieur <div style="display: flex; justify-content: space-around; align-items: center;"> <div style="background-color: black; width: 20px; height: 20px; display: inline-block;"></div> Total Negro / Black / Noir RAL 9017 </div> <div style="display: flex; justify-content: space-around; align-items: center;"> <div style="background-color: white; width: 20px; height: 20px; display: inline-block; border: 1px solid black;"></div> Total Blanco / White / Blanc RAL 9016 </div>			



NEW

Series / Série **MINIMARKET**

+Info: www.infrico.com



ERC200PH

Controlador digital IP 65.
Digital control IP65
Contrôleur digital IP 65.



ERC130PH



ERC200PH BT

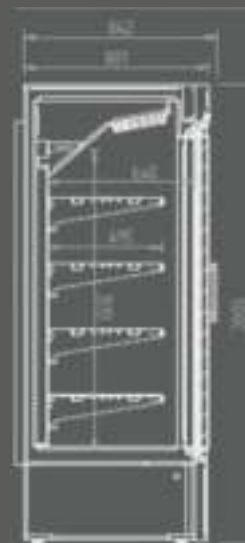

Expositor de refrigeración y congelación / Glass door merchandiser refrigerator and freezer / Armoire d'exposition réfrigération et congélation

REFRIGERACIÓN / REFRIGERATOR / POSITIVE

CONGELACIÓN / FREEZER / NÉGATIVE



MODELO MODELE MODÈLE	NEC501RV	NEC1002RV	NEC401FS	NEC501FV	NEC1002FV
Precio Price Prix					
Medidas Measures [mm] Mesures	687 x 705 x 2010 mm.	1385 x 705 x 2010 mm.	687 x 670 x 2010 mm.	687 x 705 x 2010 mm.	1385 x 705 x 2010 mm.
Temperatura Temperature Température	+2°C/+8°C		-15°C/-25°C		
Clase Climática Climatic class Classe climatique	4 / 38°C				
Tensión/Frecuencia Electrical data Tension électrique	230V/1ph/50Hz				
Controlador Controller Régulateur	Digital / Digital / Électronique IP65				
Material Material [EXT/INT] Matériel	Ext/Int acero plastificado blanco / White plastic coated steel exterior/interior / Extérieur/Intérieur acier plastifié blanc				
Espesor Thickness Épaisseur	50				
Aislamiento Isolation Isolation	40kg/m ³ / Free CFC's / Zero ODP-GWP				
Capacidad Capacity Capacité	500	1000	430	500	1000
Puertas Doors Portes	1	2	1		2
N° parrillas / Guías N° shelves / Slides N° de grilles / Glissière	5 (530x460)	10 (530x510)	5 (438x556)	5 (530x460)	10 (530x510)
Sistema de frío Cooling System Système de froid	Forzado / Forced air / Ventilé		Estático / Static / Statique	Forzado / Forced air / Ventilé	
Desescarche Defrost Dégivrage	Parada de compresor / Compressor off / Arrêt du compresseur		Manual	Gas caliente / Hot gas defrost / Gaz chaud	
Expansión Expansion Expansion	Capilar / Capillary / Capillaire				Termostática / Thermostatic / Thermostatique
Potencia Power Puissance	414	445	487	662	826
Potencia fríg. Cooling capacity Puissance Frig.	690		445	583	723
Consumo Consumption Consommation	4,22	5,05	-	8,23	16,61
Clase energética Energy class Classe Énerg.	C	B	-	C	D
Refrigerante Refrigerant Gaz	R-290				
Opcional Optional Options	<p>Iluminación Led RGB con cambio de color (por puerta) / Led lighting RGB change of colour (per door) / LED RGB avec changement de couleur (par porte)</p> <p>115V/1 ph/60 Hz 230V/1 ph/60 Hz</p> <p>Exterior (Solo Puerta, Cuadro y Rejilla) / Exterior (door, control panel and grille) / extérieur (porte, bandeau et grille)</p> <p> Negro / Black / Noir RAL 9017</p>				



Serie / Series / Série **NEC**

+Info: www.infrico.com

NEC1002FV



Cabezal iluminado
Canopy illuminated
Bandeau lumineux

Triple acristalamiento templado, bajo emisivo con carga de Argón (4-12-3-12-4)
Triple tempered glass, low emission with Argon charge (4-12-3-12-4)
Triple vitrage trempé à faible émissivité avec Argon (4-12-3-12-4)

NEC501FV

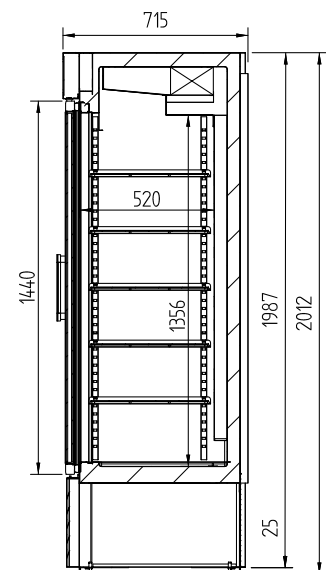

Enfriador de botellas Supercooler / Chest bottle cooler Supercooler / Réfrigérateur de bouteilles Supercooler



SPC501



SPC501B

MODELO MODELE MODÈLE	SPC501	SPC501B
Precio Price Prix		
Medidas Measures [mm] Mesures	687 x 728 x 2003 mm.	687 x 728 x 2003 mm.
Temperatura Temperature [°C] Température	+0°C/-8°C	
Clase Climática Climatic class [°C] Classe climatique	4 / 38°C	
Tensión/Frecuencia Electrical data Tension électrique	230V/1ph/50Hz	
Controlador Controller Régulateur	Digital / Digital / Électronique IP65	
Material Material [EXT/INT] Matériau	Int: acero Inox AISI 430 / Ext: acero Inox AISI 304 Int: Stainless Steel AISI 430 / Ext: Stainless Steel AISI 304 Int: Stainless Steel AISI 430 / Ext: Acier Inox AISI 304	Int: acero Inox AISI 430 / Ext: Acero lacado negro Int: Stainless Steel AISI 430 / Ext: Black lacquered steel Int: Acier Inox AISI 430 / Ext: Acier laqué noir
Espesor Thickness [mm] Épaisseur	50	
Aislamiento Isolation [mm] Isolation	40kg/m ³ / Free CFC's / Zero ODP-GWP	
Capacidad Capacity [L] Capacité	500	
Puertas Doors Portes	1	
Nº Estantes Shelving Nº d' étagères	5 [560x480]	
Sistema de frío Cooling System Système de froid	Forzado / Forced air / Ventilé	
Desescarche Defrost Dégivrage	Gas caliente / Hot gas / Gaz chaud	
Expansión Expansion Expansion	Capilar / Capillary / Capillaire	
Potencia Power [W] Puissance	757	
Potencia frig. Cooling capacity [WA -10/-30°C] Puissance Frig.	650	
Consumo Consumption [kWh/ 24h] Consommation	-	
Clase energética Energy class Classe Énerg.	-	
Refrigerante Refrigerant Gaz	R-290	
Opcional Optional Options	Parrilla / Wire shelf / Grille métallique [502x119]	



NEW

Series / Série **SPC**

+Info: www.infrico.com



SPC501



Bebida en estado líquido sin congelar.



Temperatura bajo cero en menos de 2h.



Tecnología aplicable a todo tipo de bebidas



SPC501B



SPC501

Triple acristalamiento templado, bajo emisor con carga de Argón (4-12-3-12-4)
 Triple tempered glass, low emission with Argon charge (4-12-3-12-4)
 Triple vitrage trempé à faible émissivité avec Argon (4-12-3-12-4)

Grado de alcohol Alcoholic strength Teneur en alcool	Punto de corte Set point Point de coupure
5% < 5,5%	-7°
4% < 5%	-6°
3,5% < 4%	-5°
Cerveza/Beer/Bière 0,0%	-2°
Refrescos carbonatados/ Carbonated beverages Boissons gazeuses (non alcoolisées)	-2°

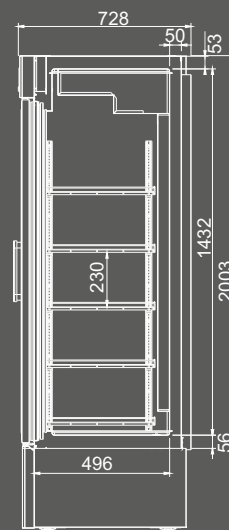

Escarchador de copas / Glass froster counter / Mini congélateur verticale

Tanque enfriador de agua / Water tank cooler / Refrigidisseurs d'eau

CONGELACIÓN / FREEZER / NÉGATIF

REFRIGERACIÓN / REFRIGERATOR / POSITIF

MODELO
MODELE
MODÈLE



ESC 50



ESC 50 CR



TA 100 II



TA 180 II

Precio Price Prix				
Medidas Measures [mm] Mesures	570 x 600 x 850 mm.	570 x 600 x 850 mm.	1312 x 562 x 570 mm.	902 x 562 x 1133 mm.
Temperatura Temperature [°C] Température	-5°C/-18°C	-5°C/-10°C	+1°C/+4°C	
Clase Climática Climatic class [°C] Classe climatique	4 / 38°C			
Tensión/Frecuencia Electrical data Tension électrique	230V/1ph/50Hz			
Controlador Controller Régulateur	Digital / Digital / Électronique IP65			
Material Material [EXT/INT] Matériel	AISI 304			
Espesor Thickness [mm] Épaisseur	60			
Aislamiento Isolation [mm] Isolation	40kg/m ³ / Free CFC's / Zero ODP-GWP			
Capacidad Capacity [L] Capacité	95	95	100	180
Puertas Doors Portes	1	1	-	
N° parrillas / Guías N° shelves / Slides N° de grilles / Glissière	2 (400 x 430)	2 (400 x 430)	-	
Sistema de frío Cooling System Système de froid	Condensación Forzada / Forced air condensation / Condensation Ventilé Evaporador estático / Static evaporator / Évaporateur statique		Forzado / Forced air / Ventilé	
Desescarche Defrost Dégivrage	-			
Expansión Expansion Expansion	Capilar / Capillary / Capillaire			
Potencia Power [W] Puissance	315	323	555	647
Potencia frig. Cooling capacity [W A -10°C] Puissance Frig.	306	306	1041	1296
Consumo Consumption [kWh/ 24h] Consommation	-			
Clase energética Energy class Classe Énerg.	-			
Refrigerante Refrigerant Gaz	R-290			
Opcional Optional Options	Juego de guías / Slides / Jeu de Glissières (503X11) Parrilla / Wire shelf / Grille (502X45)		Soporte enfriador / Wall hangers / Support (STA) KIT Filtro agua / Water filter / Filtre à eau (4600x0018)	
	115V/1 ph/60 Hz 230V/1 ph/60 Hz			



Serie / Series / Série **ESC / TA**

+Info: www.infrico.com

ESC 50



ESC 50 CR

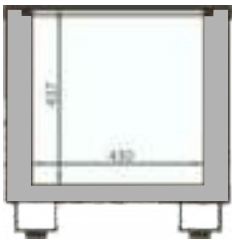

Opción Kit filtro de agua
Option Kit water filter
Optionel Kit filtre à eau



Serpentín interior en Acero Inoxidable
Stainless Steel interior coil
Serpentin intérieur en Acier Inoxydable

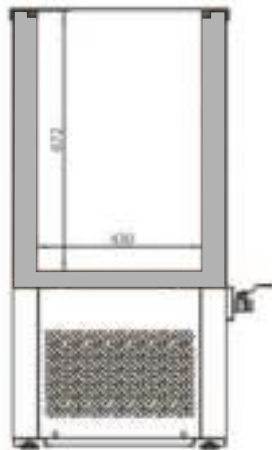

TA 100 II



TA 180 II

2. Mesas

Undercounters / Tables



EVCO

100%

88.8

Ⓛ

SET | Ⓜ | ∨ | ∧ | Ⓢ | Ⓢ | Ⓢ | Ⓢ

2. Mesas Undercounters / Tables





2. Mesas Undercounters / Tables

Controlador digital táctil e intuitivo IP 65.

Digital control easy and intuitive—touch screen IP65 protection.

Contrôleur digital tactile e intuitif IP 65.



Doble acristalamiento templado, bajo emisor con carga de Argón [4-27-4].

Double tempered glass, low-e with argon charge [4-27-4].

Double vitrage et verre trempé [4-12-3-12-4].



Encimera con fregadero opcional [BMPP F - BMGN F]

Worktop with optional sink [BMPP F - BMGN F]

Plan de travail avec évier optionnel [BMPP F - BMGN F]



Opcional: Manejo del control digital por WiFi o Bluetooth®

Optional: Operating digital control by WiFi or Bluetooth®

Optionnel: Fonctionnement de la commande numérique par WiFi ou Bluetooth®

Iluminación / Lighting / Éclairage

Incorporación de iluminación LED, llegando a reducir el consumo energético entre un 80% y 90%, respecto a una bombilla tradicional. RGB opcional.

LED lighting incorporated, reducing energetic consumption between 80% and 90% respect to a traditional light bulb. RGB optional.

Éclairage LED, réduisant la consommation énergétique entre 80% et 90%, par rapport à une ampoule traditionnelle. RGB optionnel.



+Info: www.infrico.com

Encimera reforzada con Omegas de serie [series 600/700].
Reinforced worktop with Omegas as standard [600/700 series].
Plan de travail renforcé avec Omegas en standard [séries 600/700].



Puertas con tirador de doble agarre y burlete plano desmontable "cleanless".
Double handle doors and flat gasket easily removable "cleanless".
Portes avec double poignée et joint plat facilement démontable "cleanless".



Kit cajones / Drawers kit / Kit tiroirs

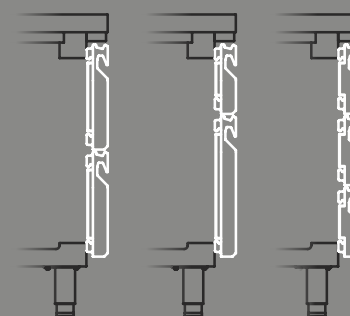

Refrigeración / Refrigeration / Réfrigération

Sistemas de frío ventilado. Bandejas evaporativas sin resistencia eléctrica para una mayor eficiencia energética. Sistemas de evaporación forzada. Evaporadores tratados con Epoxi de poliéster anticorrosión. Unidades sobredimensionadas y eficientes. Válvulas de expansión termostáticas y desescarches por gas caliente en baja temperatura. Marcos de puerta calefactados para evitar acumulación de hielo.

Forced air cooling systems. Energy-saving non-electric condensate pans. Forced evaporation systems. Evaporators treated with anti-corrosion polyester Epoxy. Oversized and efficient units. Expansion valves. Hot gas defrost. Heating door frames to prevent ice build-up.

Systèmes de froid ventilé. Bacs d'évaporation sans résistances électriques pour une meilleure efficacité énergétique. Systèmes d'évaporation forcé. Évaporateurs traités avec un époxy polyester anticorrosion. Unités efficaces et surdimensionnées. Valves d'expansion thermostatiques. Dégivrache par gaz chaud. Cadres de portes chauffés pour empêcher l'accumulation de glace.



2. Mesas

Undercounters / Tables

Serie / Series / Série

600

Mesa de refrigeración Undercounter refrigerator / Desserte dessous de comptoir positive	62 - 63
Mesa de congelación Undercounter freezer / Desserte dessous de comptoir négative	62 - 63
Mesa refrigerada con cajones Drawers undercounter refrigerator / Desserte dessous de comptoir positive avec tiroirs	62 - 63
Mesa refrigerada con puertas cristal Glass door undercounter refrigerator / Desserte dessous de comptoir positive portes vitrées	64 - 65
Mesa refrigerada con fregadero Sink undercounter refrigerator / Desserte dessous de comptoir positive avec évier	64 - 65
Mesa refrigerada pre-instalada Remote undercounter refrigerator / Desserte dessous de comptoir groupe à distance	66 - 67
Mesa refrigerada para ensaladas Salad prep refrigerator undercounter / Dessert dessous de comptoir positive préparation salades	66 - 67

Serie / Series / Série



















GN1/1 700

Mesa baja refrigeración Counter bases refrigerator / Soubassement gastronorme positif	68 - 69
Mesa de refrigeración Undercounter refrigerator / Desserte gastronorme positive	70 - 71
Mesa de congelación Undercounter freezer / Desserte gastronorme négative	70 - 71
Mesa refrigerada con cajones Drawers undercounter refrigerator / Desserte gastronorme positive avec tiroirs	70 - 71
Mesa refrigerada con puertas cristal Glass door undercounter refrigerator / Desserte gastronorme positive avec portes vitrées	72 - 73
Mesa refrigerada con fregadero Sink undercounter refrigerator / Desserte gastronorme positive avec évier	72 - 73
Mesa refrigerada pre-instalada Remote undercounter refrigerator / Desserte gastronorme groupe à distance	74 - 75
Mesa refrigerada central puertas a dos caras Pass thru undercounter refrigerator / Desserte gastronorme positive traversante	74 - 75
Mesa refrigerada para ensaladas Salad prep refrigerator table / Desserte gastronorme positive préparation salades	76 - 77
Mesa refrigerada pizza Pizza undercounter refrigerator / Desserte gastronorme positive préparation pizzas	76 - 77
Mesa refrigerada para ensaladas, pizza, kebab Salad, pizza, kebab prep refrigerator table / Mini table gastronorme positive préparation salades	78 - 81

+Info: www.infrico.com



























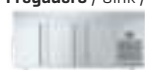











Serie / Series / Série

600

					
BMPP 1500 II	BMPP 2000 II	BMPP 2500 II	BMPP 1500 BT	BMPP 2000 BT	BMPP 2500 BT
REFRIGERACIÓN / REFRIGERATOR / POSITIVE			CONGELACIÓN / FREEZER / NÉGATIVE		
Fregadero / Sink / Evier					
					
BMPP 1500 CR	BMPP 2000 CR	BMPP 2500 CR	BMPPF 1500 II	BMPPF 2000 II	BMPPF 2500 II
REFRIGERACIÓN / REFRIGERATOR / POSITIVE			REFRIGERACIÓN / REFRIGERATOR / POSITIVE		
					
BMPP 1500 GR	BMPP 2000 GR	BMPP 1500 GRBT	BMPP 2000 GRBT	BMPP 1500 EN	BMPP 2000 EN
REFRIG / REFRIG / POSIT		CONGELACIÓN / FREEZER / NÉGATIVE		REFRIG / REFRIG / POSIT	

Serie / Series / Série

GN1/1700

									
MSG 1000	MSG 1400	MSG 1600	MSG 2000	MSG 2400					
REFRIGERACIÓN / REFRIGERATOR / POSITIVE									
									
BMGN 1470 II	BMGN 1960 II	BMGN 2450 II	BMGN 1470 BT	BMGN 1960 BT	BMGN 2450 BT				
REFRIGERACIÓN / REFRIGERATOR / POSITIF			CONGELACIÓN / FREEZER / NÉGATIVE						
F= Fregadero / Sink / Evier									
									
BMGN 1470 CR	BMGN 1960 CR	BMGN 2450 CR	BMGN 1470 F	BMGN 1960 F	BMGN 2450 F				
REFRIGERACIÓN / REFRIGERATOR / POSITIVE									
Pasante/Pass-thru/Traversante									
									
BMGN1470GR	BMGN1960GR	BMGN2450GR	BMGN1470GRBT	BMGN1960GRBT	BMGN2450GRBT	BMGN1470PDC	BMGN1960PDC		
REFRIG / REFRIG / POSIT			CONGELACIÓN / FREEZER / NÉGATIVE			REFRIG / REFRIG / POSIT			
Ensalada / Salad / Salade			Ensalada / Salad / Salade						
									
BMGN 1470 EN	BMGN 1960 EN	MPG 1490	MPG 1980	ME 1003 VIP					
REFRIGERACIÓN / REFRIGERATOR / POSITIVE									
Ensalada / Salad / Salade									
									
ME 1000 BAN	ME 1000 EN	ME 1000 II	ME 1000 PIZZA	ME 1000 KB	ME 1003 BAN	ME 1003 EN	ME 1003 II	ME 1003 PIZZA	ME 1003 KB
REFRIGERACIÓN / REFRIGERATOR / POSITIVE					REFRIGERACIÓN / REFRIGERATOR / POSITIVE				

2. Mesas

Undercounters / Tables

Serie / Series / Série

800	Mesa refrigeración y congelación euronorma 600 x 400 para pastelería Euronorm 600 x 400 refrigerator counter / Tour pâtissier positif et négatif Euronorme 600x400	82 - 83
	Mesa refrigeración euronorma 600 x 400 puerta de cristal Glass door euronorm 600x400 counter refrigerator / Tour pâtissier positif Euronorme 600x400 portes vitrées	84 - 85
	Mesa refrigeración euronorma 600 x 400 remota Euronorm 600x400 remote counter refrigerator / Tour pâtissier positif Euronorme 600x400 groupe à distance	84 - 85
	Mesa refrigerada central euronorma 600 x 400 puertas a dos caras cristal Pass thru counter refrigerator / Tour pâtissier positif Euronorme 600x400 traversante	86 - 87
	Mesa refrigerada euronorma 600 x 400 para ensaladas, pizza y pastelería Euronorma 600 x 400 salads, pizza & pastry drep refrigerator counter Table positive Euronorme 600x400 préparation salades, pizzas et pâtisseries	86 - 87

Serie / Series / Série

NEW MR H 800	Mesa refrigerada ventilada con control de humedad Ventilated refrigerated table with humidity control Table réfrigéré ventilée avec contrôle de l'humidité	88 - 89
---------------------	---	----------------

Serie / Series / Série

MPL800	Mesa refrigerada pizza Lucena Pizza prep table / Table positive pizza et fast food Lucena	90 - 91
---------------	---	----------------

Serie / Series / Série

MP800	Mesa refrigerada pizza Pizza prep table / Table positive pizza	90 - 91
--------------	--	----------------

Serie / Series / Série

FMPP	Frente mostrador refrigerado Back bar counter refrigerator / Desserte arrière bar positive cafétéria	92 - 93
	Frente mostrador refrigerado preinstalado Remote back-bar counter refrigerator / Desserte arrière bar positive groupe à distance cafétéria	92 - 93
	Frente mostrador refrigerado con cajones Drawers back-bar counter refrigerator / Desserte arrière bar positive avec tiroirs cafétéria	92 - 93

Serie / Series / Série

MCAF	Mueble mesa cafetera Coffe unit / Meuble cafétéria	94
-------------	--	-----------

Serie / Series / Série





ME / MT	Mueble estantería y mesa de trabajo Shelf unit and working table / Meuble étagère et table de travail	95
----------------	---	-----------

+Info: www.infrico.com

Serie / Series / Série







800

EURONORM 600x400

MR 1620 **MR 2190** **MR 2750** | **MR 1620 BT** **MR 2190 BT**
REFRIGERACIÓN / REFRIGERATOR / POSITIF | CONGELACIÓN / FREEZER / NÉGATIF







EURONORM 600x400

MR 1620 CR **MR 2190 CR** **MR 2750 CR** **MR 1620 GR** **MR 2190 GR** **MR 2750 GR**
REFRIGERACIÓN / REFRIGERATOR / POSITIF

EURONORM 600x400

Pasante/Pass-thru/Traversante

MR 1620 PDC **MR 2190 PDC** **MR 1620 PDCR** **MR 2190 PDCR** **MR 1620 EN** **MR 2190 EN**
REFRIGERACIÓN / REFRIGERATOR / POSITIVE

EURONORM 600x400
Ensalada, pizza y pastelería
Salads, pizza & pastry
Salade, pizza et pâtisserie

Serie / Series / Série

MR H 800

NEW  **NEW** 







MR 1620 H **MR 2190 H**
REFRIGERACIÓN + CONTROL HUMEDAD /
REFRIGERATOR + HUMIDITY CONTROL /
POSITIVE + CONTRÔLE DE L'HUMIDITÉ

Serie / Series / Série

MPL800
MP800

EURONORM 600x400

Pizza

MPL 1740 **MPL 2300** **MP 1740** **MP 2300** **MP 1740 CN** **MP 2300 CN**
REFRIGERACIÓN / REFRIGERATOR / POSITIVE

Serie / Series / Série

FMPP











FMPP1500 II **FMPP2000 II** **FMPP2500 II** **FMPP1500 CR** **FMPP2000 CR** **FMPP2500 CR** **FMPP1500 GR** **FMPP2000 GR** **FMPP2500 GR**
REFRIGERACIÓN / REFRIGERATOR / POSITIVE

Serie / Series / Série

MCAF







MCAF 820 **MCAF 1000 CD** **MCAF 1000 CI** **MCAF 1500** **MCAF 2000** **MCAF 2500**
MESA CAFETERA / COFFE UNIT / MEUBLE CAFÉTÉRIA

Serie / Series / Série

ME / MT









ME 30/1000 **ME 30/1500** **ME 30/2000** **ME 30/2500** | **ME 60/1000** **ME 60/1500** **ME 60/2000** **ME 60/2500**
MUEBLE ESTANTERÍA / SHELF UNIT / MEUBLE ÉTAGÈRE | MESA DE TRABAJO / WORKING TABLE / TABLE DE TRAVAIL













MT 60/1000 **MT 60/1500** **MT 60/2000** **MT 70/1000** **MT 70/1500** **MT 70/2000**
MESA DE TRABAJO / WORKING TABLE / TABLE DE TRAVAIL

Mesa de refrigeración y congelación / Undercounter refrigerator and freezer / Desserte dessus de comptoir positive et négative

MODELO MODELE MODÈLE						
	BMPP 1500 II	BMPP 2000 II	BMPP 2500 II	BMPP 1500 BT	BMPP 2000 BT	BMPP 2500 BT
Precio Price Prix						
Medidas Measures [mm] Mesures	1468 x 600 x 850 mm.	1960 x 600 x 850 mm.	2452 x 600 x 850 mm.	1468 x 600 x 850 mm.	1960 x 600 x 850 mm.	2452 x 600 x 850 mm.
Temperatura Temperature Température	-2°C/+8°C			-18°C		
Clase Climática Climatic class Classe climatique	5 / 40° C			4 / 38°C		
Tensión/Frecuencia Electrical data Tension électrique	230V/1ph/50Hz					
Controlador Controller Régulateur	Digital IP65					
Material Material [EXT/INT] Matériel	AISI 304					
Espesor Thickness Épaisseur	70					
Aislamiento Isolation Isolation	40kg/m ³ / Free CFC's / Zero ODP-GWP					
Capacidad Capacity Capacité	250	385	510	250	385	510
Puertas Doors Portes	2	3	4	2	3	4
N° parrillas / Guías N° shelves / Slides N° de grilles / Glissière	2/2 [325x430]	3/3 [325x430]	4/4 [325x430]	2/2 [325x430]	3/3 [325x430]	4/4 [325x430]
Sistema de frío Cooling System Système de froid	Monoblock ventilado / Forced air monoblock / Monoblock ventilé					
Desescarche Defrost Dégivrage	Parada compresor / Compressor off / Arrêt du compresseur			Gas caliente / Hot gas / Gaz chaud		
Expansión Expansion Expansion	Capilar / Capillary / Capillaire			Válvula termostática / Expansion valve / Détendeur thermostatique		
Potencia Power Puissance	260	260	446	443	472	561
Potencia frig. Cooling capacity Puissance Frig.	370	370	690	445	445	540
Consumo Consumption Consommation	1,55	1,80	2,05	4,02	6,57	6,78
Clase energética Energy class Classe Énerg.	A			C	D	C
Refrigerante Refrigerant Gaz	R-290					
Opcional Optional Options	Parrilla / Wire shelf / Grille [502X07] Cerradura / Lock / Serrure [506X209; 506X210] Juego de guías / Slides / Jeu de Glissières [GUIACO115430, GUIACO215430] Grupo lado contrario / Group opposite side / Groupe opposé [L]			115V/1ph/60Hz Ruedas / Casters / Roulettes [705X16=2; 705X17=2] Sin peto trasero / Without backsplash / Sans dossier		230V/1ph/60Hz
	Kit cajones / Drawer Kit / Kit tiroirs BM 1/2 x 200 [JCAJ17BM1/2] BM 1/3 x 100 [JCAJ17BM1/3] BM 2/3 + BM 1/3 [JCAJ17BM2/3]					

Serie / Series / Série **600**

+Info: www.infrico.com

BMPP 2000 II



Controlador digital IP 65.
Digital control IP65
Contrôleur digital IP 65.



Refuerzo con Omegas.
Omega reinforcement.
Renforcement avec Omegas.

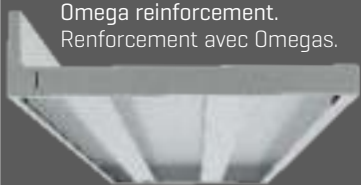



Internet of things

Opcional: Manejo control digital por WiFi o Bluetooth®
Optional: Operating digital control by WiFi or Bluetooth®

Circulación optimizada del aire
Optimal air flow
Circulation d'air optimisée

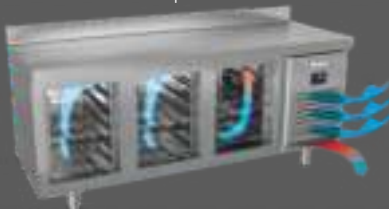

Sistema de ventilación de condensación frontal
Front breathing condensation system
Système de ventilation à condensation frontale

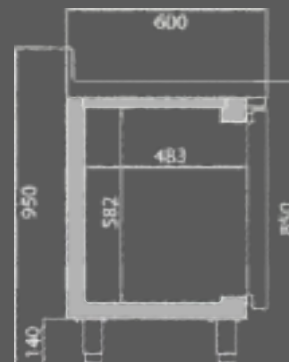

Kit 2 cajones
2 drawers kit
Kit 2 tiroirs

BM 1/2 x 200



Kit 2 cajones
2 drawers kit
Kit 2 tiroirs

BM 2/3x300 +
BM 1/3x100



Kit 3 cajones
3 drawers kit
Kit 3 tiroirs

BM 1/3x100

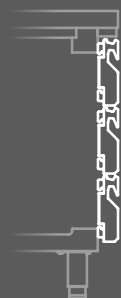

1/2
302 x 418 x 205

2/3
302 x 418 x 307

1/3
302 x 418 x 105









KIT CAJONES / DRAWERS KIT / KIT TIROIRS (MOD. II)

Mesa refrigerada puertas cristal /
Glass Door undercounter refrigerator /
 Desserte dessus de comptoir posit. portes vitrées

Mesa refrigerada con fregadero /
Sink undercounter refrigerator /
 Desserte dessus de comptoir posit. avec évier

F= Fregadero / Sink / Evier

MODELO MODELE MODÈLE						
Precio Price Prix						
Medidas Measures [mm] Mesures	1468 x 600 x 850 mm.	1960 x 600 x 850 mm.	2452 x 600 x 850 mm.	1468 x 600 x 850 mm.	1960 x 600 x 850 mm.	2452 x 600 x 850 mm.
Temperatura Temperature Température	+2°C/+6°C			-2°C/+8°C		
Clase Climática Climatic class Classe climatique	4 / 38°C			5 / 40°C		
Tensión/Frecuencia Electrical data Tension électrique	230V/1ph/50Hz					
Controlador Controller Régulateur	Digital IP65					
Material Material [EXT/INT] Matériel	AISI 304					
Espesor Thickness Épaisseur	70					
Aislamiento Isolation Isolation	40kg/m ³ / Free CFC's / Zero ODP-GWP					
Capacidad Capacity Capacité	250	385	510	250	385	510
Puertas Doors Portes	2	3	4	2	3	4
Nº parrillas / Guías Nº shelves / Slides Nº de grilles / Glissière	2/2 [325x430]	3/3 [325x430]	4/4 [325x430]	2/2 [325x430]	3/3 [325x430]	4/4 [325x430]
Sistema de frío Cooling System Système de froid	Monoblock ventilado / Forced air monoblock / Monoblock ventilé					
Desescarche Defrost Dégivrage	Parada compresor / Compressor off / Arrêt du compresseur					
Expansión Expansion Expansion	Capilar / Capillary / Capillaire					
Potencia Power Puissance	270	382	387	260	260	446
Potencia frig. Cooling capacity Puissance Frig.	370	690	690	370	370	690
Consumo Consumption Consommation	-	-	-	1,55	1,80	2,05
Clase energética Energy class Classe Énerg.	-			A	A	A
Refrigerante Refrigerant Gaz	R-290					
Opcional Optional Options	<p>Juego de guías / Slides / Jeu de Glissières [GUIAC0115430, GUIAC0215430] Grupo lado contrario / Group opposite side / Groupe opposé [L] 115V/1ph/60Hz 230V/1ph/60Hz Kit cajones / Drawer Kit / Kit tiroirs BM 1/2 x 200 [JCAJ17BM1/2] BM 1/3 x 100 [JCAJ17BM1/3] BM 2/3 + BM 1/3 [JCAJ17BM2/3]</p>					
	Parrilla / Wire shelf / Grille [502X43] Cerradura / Lock / Serrure [506X60] Iluminación Led RGB con cambio de color [por puerta] / Led lighting RGB change of colour [per door] / LED RGB avec changement de couleur [par porte]			Parrilla / Wire shelf / Grille [502X07] Cerradura / Lock / Serrure [506X209; 506X210]		

Serie / Series / Série **600**

+Info: www.infrico.com

Doble cristal templado bajo emisivo más carga Argón 4-27-4
 Double tempered glass low-e + Argón 4-27-4
 Double vitrage trempé à faible émissivité avec^o Argón 4-27-4

BMPP 1500 CR

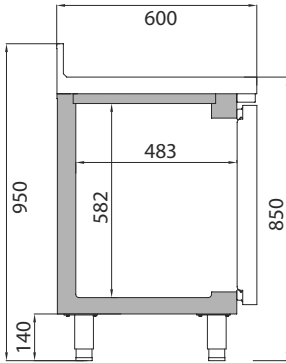

F= Fregadero / Sink / Evier
BMPPF 1500 II



Opcional
 Optional
 Option

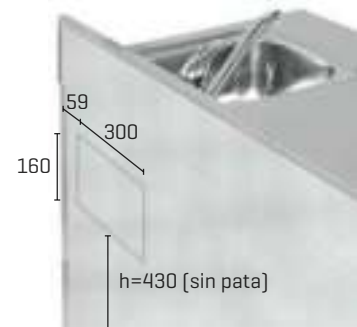

Kit 2 cajones
 2 drawers kit
 Kit 2 tiroirs

BM 1/2 x 200

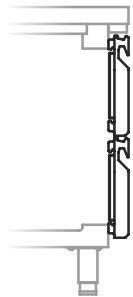

Kit 2 cajones
 2 drawers kit
 Kit 2 tiroirs

BM 2/3x300 +
 BM 1/3x100

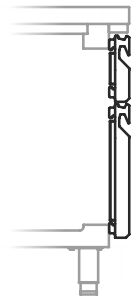

Kit 3 cajones
 3 drawers kit
 Kit 3 tiroirs

BM 1/3x100

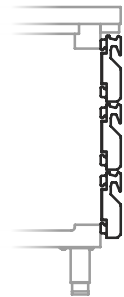

1/2 2/3 1/3
302 x 418 x 205 302 x 418 x 307 302 x 418 x 105









KIT CAJONES / DRAWERS KIT / KIT TIROIRS (MOD. CR)

Mesa refrigerada pre-instalada /
Remote undercounter refrigerator /
Desserte dessus de comptoir groupe à distance

Mesa refrigerada ensaladas /
Salad prep refrigerator undercounter /
Desserte dessus de comptoir posit. prép. salades

Ensaladas / Salad prep / Prép. salades

MODELO MODELE MODÈLE						
	BMPP 1500 GR	BMPP 2000 GR	BMPP 1500 GRBT	BMPP 2000 GRBT	BMPP 1500 EN	BMPP 2000 EN
Precio Price Prix						
Medidas Measures [mm] Mesures	1240 x 600 x 850 mm.	1732 x 600 x 850 mm.	1240 x 600 x 850 mm.	1732 x 600 x 850 mm.	1468 x 600 x 1100 mm.	1960 x 600 x 1100 mm.
Temperatura Temperature Température	0°C/+6°C		-18°C		0°C/+6°C	
Clase Climática Climatic class Classe climatique			-		4 / 38°C	
Tensión/Frecuencia Electrical data Tension électrique	230V/1ph/50Hz					
Controlador Controller Régulateur	Digital IP65					
Material Material [EXT/INT] Matériel	AISI 304					
Espesor Thickness Épaisseur	70					
Aislamiento Isolation Isolation	40kg/m ³ / Free CFC's / Zero ODP-GWP					
Capacidad Capacity Capacité	250	385	250	385	250+50	385+70
Puertas Doors Portes	2	3	2	3	2	3
N° parrillas / Guías N° shelves / Slides N° de grilles / Glissière	2/2 [325x430]	3/3 [325x430]	2/2 [325x430]	3/3 [325x430]	2/2 [325x430]	3/3 [325x430]
Sistema de frío Cooling System Système de froid	Monoblock ventilado / Forced air monoblock / Monoblock ventilé					
Desescarche Defrost Dégivrage	Parada compresor / Compressor off / Arrêt du compresseur		Gas caliente / Hot gas / Gaz chaud		Parada compresor / Compressor off / Arrêt du compresseur	
Expansión Expansion Expansion	Opcional / Optional / Options				Capilar / Capillary / Capillaire	
Potencia Power Puissance			-		249	249
Potencia frig. Cooling capacity Puissance Frig.	Recom. 370	Recom. 370	Recom. 445	Recom. 445	370	370
Consumo Consumption Consommation	-					
Clase energética Energy class Classe Énerg.	-					
Refrigerante Refrigerant Gaz	-				R-290	
Opcional Optional Options	Juego de guías / Slides / Jeu de Glissières [GUIAC0115430, GUIAC0215430] Cerradura / Lock / Serrure [506X209; 506X210] Parrilla / Wire shelf / Grille [502X07] 115V/1ph/60Hz 230V/1ph/60Hz					
	Válvula expansión [especificar refrig.] / Expansion valve [specify refrig.] / Détendeur [spécifier le gaz] Puerta de cristal [unidad] / Glass door [unit] / Porte vitrée [unité] [PUE17IDGN-PUE17IIGN][GR]				Ruedas / Casters / Roulettes [705X16=2; 705X17=2] BMPP 1500 EN [501X16] = 8 BMPP 2000 EN [501X16] = 11	
	Kit cajones / Drawer Kit / Kit tiroirs BM 1/2 x 200 [JCAJ17BM1/2] BM 1/3 x 100 [JCAJ17BM1/3] BM 2/3 + BM 1/3 [JCAJ17BM2/3]		Kit cajones / Drawer Kit / Kit tiroirs Bajo consultar / On request / À la demande		Kit cajones / Drawer Kit / Kit tiroirs BM 1/2 x 200 [JCAJ17BM1/2] BM 1/3 x 100 [JCAJ17BM1/3] BM 2/3 + BM 1/3 [JCAJ17BM2/3]	

Serie / Series / Série **600**

+Info: www.infrico.com

Video del producto
Product Video
Vidéo du produit



Infrico Youtube



Refuerzo con Omegas.
Omega reinforcement.
Renforcement avec Omegas.

Posibilidad de acceso frontal y lateral para una mejor manipulación.
Front and lateral access for better handling
Possibilité d'accès frontal et latéral pour une meilleure manipulation.

BMPP 1500 GR



Refrigeración estática en la cuba
Static cooling in the tank
Refroidissement statique supérieur



BMPP 2000 EN

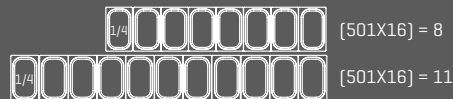

Kit 2 cajones
2 drawers kit
Kit 2 tiroirs

BM 1/2 x 200



Kit 2 cajones
2 drawers kit
Kit 2 tiroirs

BM 2/3x300 +
BM 1/3x100



Kit 3 cajones
3 drawers kit
Kit 3 tiroirs

BM 1/3x100

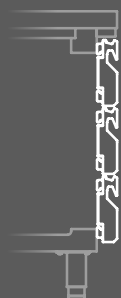





1/2 2/3 1/3
302 x 418 x 205 302 x 418 x 307 302 x 418 x 105



KIT CAJONES / DRAWERS KIT / KIT TIROIRS (MOD. GR - EN)

Mesa baja refrigeración / Counter bases refrigerator / Soubassement gastronorme positif

MODELO MODELE MODÈLE					
	MSG 1000	MSG 1400	MSG 1600	MSG 2000	MSG 2400
Precio Price Prix					
Medidas Measures [mm] Mesures	1000 x 700 x 650 mm.	1400 x 700 x 650 mm.	1600 x 700 x 650 mm.	2000 x 700 x 650 mm.	2400 x 700 x 650 mm.
Temperatura Temperature Température	-2°C/+8°C				
Clase Climática Climatic class Classe climatique	5 / 40°C				
Tensión/Frecuencia Electrical data Tension électrique	230V/1ph/50Hz				
Controlador Controller Régulateur	Digital IP65				
Material Material [EXT/INT] Matériel	AISI 304				
Espesor Thickness Épaisseur	70				
Aislamiento Isolation Isolation	40kg/m ³ / Free CFC's / Zero ODP-GWP				
Capacidad Capacity Capacité	100	190	225	310	435
Puertas Doors Portes	2	4	4	6	8
Nº parrillas / Guías Nº shelves / Slides Nº de grilles / Glissière	-				
Sistema de frío Cooling System Système de froid	Ventilado / Forced air / Ventilé				
Desescarche Defrost Dégivrage	Parada compresor / Compressor off / Arrêt du compresseur				
Expansión Expansion Expansion	Capilar / Capillary / Capillaire				
Potencia Power Puissance	205	210			368
Potencia frig. Cooling capacity Puissance Frig.	370				690
Consumo Consumption Consommation	0,98	1,23	1,33	1,61	1,77
Clase energética Energy class Classe Énerg.	A	A	A	B	B
Refrigerante Refrigerant Gaz	R-290				
Opcional Optional Options	Cerradura / Lock / Serrure [506X209; 506X210] Puerta [unidad] / Door [unit] / Porte [unité] [PUE17ISN] Cajón / Drawer / Tiroir 2/3x300 [JCAJ17SN2/3]				

Serie / Series / Série **GN1/1 700**

+Info: www.infrico.com

MSG 2000



Refuerzo con Omegas.
Omega reinforcement.
Renforcement avec Omegas.



Controlador digital IP 65.
Digital control IP65
Contrôleur digital IP 65.



Opcional: Manejo control digital por WiFi o Bluetooth*

Optional: Operating digital control by WiFi or Bluetooth*

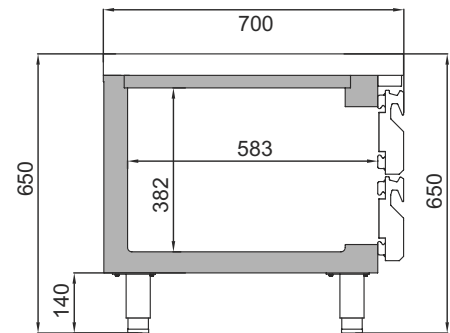







Puertas opcionales
Optionals doors
Portes en option



MSG 1400

Mesa refrigeración y congelación / Undercounter refrigerator and freezer / Desserte gastronomique positive et négative

MODELO MODELE MODÈLE						
	BMGN 1470 II	BMGN 1960 II	BMGN 2450 II	BMGN 1470 BT	BMGN 1960 BT	BMGN 2450 BT
Precio Price Prix						
Medidas Measures [mm] Mesures	1468 x 700 x 850 mm.	1960 x 700 x 850 mm.	2452 x 700 x 850 mm.	1468 x 700 x 850 mm.	1960 x 700 x 850 mm.	2452 x 700 x 850 mm.
Temperatura Temperature Température [°C]	-2°C/+8°C			-18°C		
Clase Climática Climatic class Classe climatique [°C]	5 / 40°C			4 / 38°C		
Tensión/Frecuencia Electrical data Tension électrique	230V/1ph/50Hz					
Controlador Controller Régulateur	Digital IP65					
Material Material [EXT/INT] Matériel	AISI 304					
Espesor Thickness Épaisseur [mm]	70					
Aislamiento Isolation Isolation [mm]	40kg/m ³ / Free CFC's / Zero ODP-GWP					
Capacidad Capacity Capacité [L]	305	465	630	305	465	630
Puertas Doors Portes	2	3	4	2	3	4
Nº parrillas / Guías Nº shelves / Slides Nº de grilles / Glissière	2/10 {325x530}	3/15 {325x530}	4/20 {325x530}	2/10 {325x530}	3/15 {325x530}	4/20 {325x530}
Sistema de frío Cooling System Système de froid	Monoblock ventilado / Forced air monoblock / Monoblock ventilé					
Desescarche Defrost Dégivrage	Parada compresor / Compressor off / Arrêt du compresseur			Gas caliente / Hot gas defrost / Gaz chaud		
Expansión Expansion Expansion	Capilar / Capillary / Capillaire			Válvula de expansión termostática / Thermostatic expansion valve / Détendeur thermostatique		
Potencia Power Puissance [W]	210	368		508	597	711
Potencia frig. Cooling capacity Puissance Frig. [W A -10°C]	570	690		445	540	640
Consumo Consumption Consommation [kWh/ 24h]	1,50	1,95	2,25	5,45	7,71	9,03
Clase energética Energy class Classe Énerg.	A			C	D	D
Refrigerante Refrigerant Gaz	R-290					
Opcional Optional Options	Sin peto trasero / Without backsplash / Sans dosseret Parrilla / Wire shelf / Grille [502X12] Juego de guías / Slides / Jeu de Glissières [GUIAC0115530, GUIAC0215530] Cerradura / Lock / Serrure [506X209; 506X210] Grupo lado contrario / Group opposite side / Groupe opposé [L]				115V/1ph/60Hz 230V/1ph/60Hz Ruedas / Casters / Roulettes [705X16=2; 705X17=2]	
	Kit cajones / Drawer Kit / Kit tiroirs BMGN 1/2 x 200 [JCAJ17GN1/2] BMGN 1/3 x 100 [JCAJ17GN1/3] BMGN 2/3 + BMGN 1/3 [JCAJ17GN2/3]					

Serie / Series / Série **GN1/1 700**

+Info: www.infrico.com

BMGN 1470 II

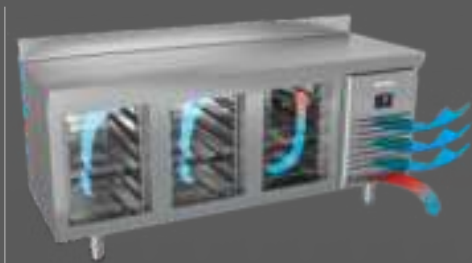

Refuerzo con Omegas.
Omega reinforcement.
Renforcement avec Omegas.



Kit 2 cajones
2 drawers kit
Kit 2 tiroirs

BM 1/2 x 200



Kit 2 cajones
2 drawers kit
Kit 2 tiroirs

BM 2/3x300 +
BM 1/3x100



Kit 3 cajones
3 drawers kit
Kit 3 tiroirs

BM 1/3x100



1/2
302 x 518 x 205

2/3
302 x 518 x 307

1/3
302 x 518 x 105









KIT CAJONES / DRAWERS KIT / KIT TIROIRS (MOD. II)

Mesa refrigerada puertas cristal /
Glass Door undercounter refrigerator /
 Desserte dessus de comptoir posit. portes vitrées

Mesa refrigerada con fregadero /
Sink undercounter refrigerator /
 Desserte dessus de comptoir posit. avec évier

F= Fregadero / Sink / Evier

MODELO MODELE MODÈLE						
	BMGN 1470 CR	BMGN 1960 CR	BMGN 2450 CR	BMGN 1470 F	BMGN 1960 F	BMGN 2450 F
Precio Price Prix						
Medidas Measures [mm] Mesures	1468 x 700 x 850 mm.	1960 x 700 x 850 mm.	2452 x 700 x 850 mm.	1468 x 700 x 850 mm.	1960 x 700 x 850 mm.	2452 x 700 x 850 mm.
Temperatura Temperature Température	+2°C/+6°C			-2°C/+8°C		
Clase Climática Climatic class Classe climatique	4 / 38°C			5 / 40°C		
Tensión/Frecuencia Electrical data Tension électrique	230V/1ph/50Hz					
Controlador Controller Régulateur	Digital IP65					
Material Material [EXT/INT] Matériel	AISI 304					
Espesor Thickness Épaisseur	70					
Aislamiento Isolation Isolation	40kg/m ³ / Free CFC's / Zero ODP-GWP					
Capacidad Capacity Capacité	305	465	630	305	465	630
Puertas Doors Portes	2	3	4	2	3	4
Nº parrillas / Guías Nº shelves / Slides Nº de grilles / Glissière	2/10 [325x530]	3/15 [325x530]	4/20 [325x530]	2/10 [325x530]	3/15 [325x530]	4/20 [325x530]
Sistema de frío Cooling System Système de froid	Monoblock ventilado / Forced air monoblock / Monoblock ventilé					
Desescarche Defrost Dégivrage	Parada compresor / Compressor off / Arrêt du compresseur					
Expansión Expansion Expansion	Capilar / Capillary / Capillaire					
Potencia Power Puissance	377	382	387	210	368	
Potencia frig. Cooling capacity Puissance Frig.	690	690	690	370	690	
Consumo Consumption Consommation		-		1,50	1,95	2,25
Clase energética Energy class Classe Énerg.		-		A	A	A
Refrigerante Refrigerant Gaz	R-290					
Opcional Optional Options	Juego de guías / Slides / Jeu de Glissières [GUIACO115530, GUIACO215530]					
	Parrilla doble tupida / Extradense wire shelf / Grille renforcée [502X62] Parrilla inoxidable / Stainless steel wire shelf / Grille Inox [502X46] Iluminación Led RGB con cambio de color [por puerta] / Led lighting RGB change of colour [per door] / LED RGB avec changement de couleur [par porte] Cerradura / Lock / Serrure [506X60]			Parrilla / Wire shelf / Grille [502X12] Cerradura / Lock / Serrure [506X209; 506X210] Grupo lado contrario / Group opposite side / Groupe opposé [L] Kit cajones / Drawer Kit / Kit tiroirs BMGN 1/2 x 200 [JCAJ17GN1/2] BMGN 1/3 x 100 [JCAJ17GN1/3] BMGN 2/3 + BMGN 1/3 [JCAJ17GN2/3]		

Serie / Series / Série **GN1/1 700**

+Info: www.infrico.com

BMGN 1470 CR



Doble cristal templado bajo emisivo más carga Argón 4-27-4
 Double tempered glass low-e + Argón 4-27-4
 Double vitrage trempé à faible émissivité avec Argon

F= Fregadero / Sink / Evier
BMGN F

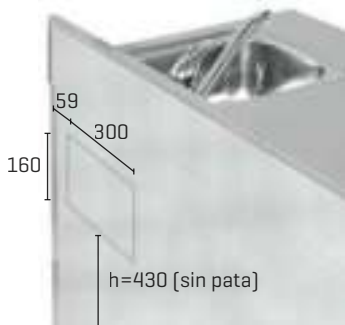



Opcional: Manejo control digital por WiFi o Bluetooth*

Optional: Operating digital control by WiFi or Bluetooth*

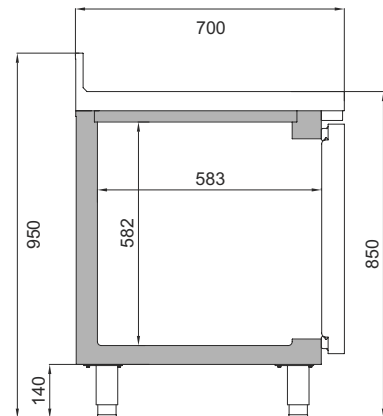

Kit 2 cajones
 2 drawers kit
 Kit 2 tiroirs

BM 1/2 x 200



Kit 2 cajones
 2 drawers kit
 Kit 2 tiroirs

BM 2/3x300 +
 BM 1/3x100

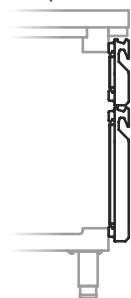

Kit 3 cajones
 3 drawers kit
 Kit 3 tiroirs

BM 1/3x100



1/2
302 x 518 x 205
2/3
302 x 518 x 307
1/3
302 x 518 x 105



KIT CAJONES / DRAWERS KIT / KIT TIROIRS (MOD. F)

Mesa refrigerada pre-instalada / Remote undercounter refrigerator / Desserte dessus de comptoir groupe á distance

Mesa refrigerada central puertas a dos caras / Pass thru undercounter refrigerator / Desserte gastronomique positive traversante

MODELO MODELE MODÈLE	BMGN 1470 GR	BMGN 1960 GR	BMGN 2450 GR	BMGN 1470 GRBT	BMGN 1960 GRBT	BMGN 2450 GRBT	BMGN 1470 PDC	BMGN 1960 PDC
Precio Price Prix								
Medidas Measures [mm] Mesures	1240 x 700 x 850 mm.	1732 x 700 x 850 mm.	2224 x 700 x 850 mm.	1240 x 700 x 850 mm.	1732 x 700 x 850 mm.	2224 x 700 x 850 mm.	1468 x 700 x 850 mm.	1960 x 700 x 850 mm.
Temperatura Temperature Température	-2°C/+8°C			-18°C			-2°C/+8°C	
Clase Climática Climatic class Classe climatique	-			-			5 / 40°C	
Tensión/Frecuencia Electrical data Tension électrique	230V/1ph/50Hz							
Controlador Controller Régulateur	Digital IP65							
Material Material [EXT/INT] Matériel	Inox AISI 304							
Espesor Thickness Épaisseur	70							
Aislamiento Isolation Isolation	40kg/m ³ / Free CFC's / Zero ODP-GWP							
Capacidad Capacity Capacité	305	465	630	305	465	630	290	440
Puertas Doors Portes	2	3	4	2	3	4	4	6
Nº parrillas / Guías Nº shelves / Slides Nº de grilles / Glissière	2/10 (325x530)	3/15 (325x530)	4/20 (325x530)	2/10 (325x530)	3/15 (325x530)	4/20 (325x530)	2/10 (325x530)	3/15 (325x530)
Sistema de frío Cooling System Système de froid	-						Monoblock ventilado / Forced air monoblock / Monoblock ventilé	
Desescarche Defrost Dégivrage	Parada compresor / Compressor off / Arrêt du compresseur			Gas caliente / Hot gas / Gaz chaud			Parada compresor / Compressor off / Arrêt du compresseur	
Expansión Expansion Expansion	-						Capilar / Capillary / Capillaire	
Potencia Power Puissance	-			-			210	368
Potencia frig. Cooling capacity Puissance Frig.	343	690	690	445	540	640	370	690
Consumo Consumption Consommation	-			-			1,50	1,95
Clase energética Energy class Classe Énerg.	-			-			A	A
Refrigerante Refrigerant Gaz	-						R-290	
Opcional Optional Options	Puerta de cristal / Glass door / Porte vitrée (PUE17IDGN-PUE17IIGN) Cerradura / Lock / Serrure (506X209; 506X210) Parrilla / Wire shelf / Grille (502X12)						115V/1ph/60Hz 230V/1ph/60Hz	
	Kit cajones / Drawer Kit / Kit tiroirs BMGN 1/2 x 200 [JCAJ17GN1/2] BMGN 1/3 x 100 [JCAJ17GN1/3] BMGN 2/3 + BMGN 1/3 [JCAJ17GN2/3]			Kit cajones / Drawer Kit / Kit tiroirs Bajo consultar / On request / À la demande			Juego de guías / Slides / Jeu de Glissières [GUIAC03505]	
	Válvula de expansión (especificar refrigerante) Expansion valve (specify refrigerant) Détendeur d'expansion (spécifier le gaz souhaité) Juego de guías / Slides / Jeu de Glissières [GUIAC0115530, GUIAC0215530]						Parrilla inoxidable / Stainless steel wire shelf / Grille Inox [502X46]	

Serie / Series / Série **GN1/1 700**

+Info: www.infrico.com



Possibilidad de acceso frontal y lateral para una mejor manipulación
 Front and lateral access for better handling
 Possibilité d'accès frontal et latéral pour une meilleure manipulation.

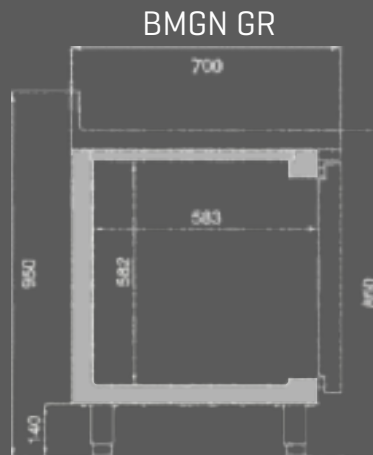
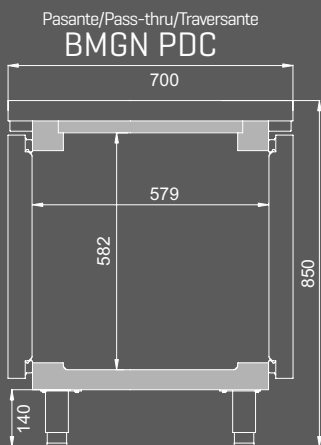

Kit 2 cajones
 2 drawers kit
 Kit 2 tiroirs

Kit 2 cajones
 2 drawers kit
 Kit 2 tiroirs

Kit 3 cajones
 3 drawers kit
 Kit 3 tiroirs

1/2
302 x 518 x 205

2/3
302 x 518 x 307

1/3
302 x 518 x 105

BM 1/2 x 200

BM 2/3x300 + BM 1/3x100

BM 1/3x100

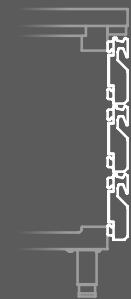

KIT CAJONES / DRAWERS KIT / KIT TIROIRS [MOD. GR]

Mesa refrigerada ensaladas /
Salad prep refrigerator table /
Desserte gastronomique positive préparation salades

Mesa refrigerada pizza /
Pizza undercounter refrigerator /
Desserte gastronomique positive préparation pizza

	Ensalada / Salad / Salade		Pizza / Pizza / Pizza		
MODELO MODELE MODÈLE	BMGN 1470 EN	BMGN 1960 EN	MPG 1490	MPG 1980	ME 1003 VIP
Precio Price Prix					
Medidas Measures [mm] Mesures	1468 x 700 x 850/1100 mm.	1960 x 700 x 850/1100 mm.	1490 x 700 x 830/1417 mm.	1980 x 700 x 830/1417 mm.	1490 x 700 x 885/1417 mm.
Temperatura Temperature Température	0°/+6°C.		0°/+6°C. +4°C/+8°C.		
Clase Climática Climatic class Classe climatique	4 / 38°C				
Tensión/Frecuencia Electrical data Tension électrique	230V/1ph/50Hz				
Controlador Controller Régulateur	Digital IP65				
Material Material [EXT/INT] Matériel	Inox AISI 304				
Espesor Thickness Épaisseur	70				
Aislamiento Isolation Isolation	40kg/m ³ / Free CFC's / Zero ODP-GWP				
Capacidad Capacity Capacité	305+65	465+85	305+35	465+54	355+35
Puertas Doors Portes	2	3	2	3	3
N° parrillas / Guías N° shelves / Slides N° de grilles / Glissière	2/10 [325x530]	3/15 [325x530]	2/10 [325x530]	3/15 [325x530]	3/9 [325x530]
Sistema de frío Cooling System Système de froid	Monoblock ventilado / Forced air monoblock / Monoblock ventilé				
Desescarche Defrost Dégivrage	Parada compresor / Compressor off / Arrêt du compresseur				
Expansión Expansion Expansion	Capilar / Capillary / Capillaire				
Potencia Power Puissance	210	368	369	553	503
Potencia frig. Cooling capacity Puissance Frig.	370	690	370+170	690+170	690+170
Consumo Consumption Consommation	-	-	-	-	-
Clase energética Energy class Classe Énerg.	-	-	-	-	-
Refrigerante Refrigerant Gaz	R-290				
Opcional Optional Options	Parrilla / Wire shelf / Grille [502X12] Juego de guías / Slides / Jeu de Glissières [GUIAC0115530, GUIAC0215530] Cerradura / Lock / Serrure [506X209; 506X210] 230V/1ph/60Hz 115V/1ph/60Hz				
	{501X13} = 1 {501X11} = 6 {501X13} = 1 {501X11} = 9		{501X16} = 6 {501X13} = 1 {501X16} = 7		{501X16} = 6
	Ruedas / Casters / Roulettes [705X16=2; 705X17=2]				

Serie / Series / Série **GN1/1 700**

+Info: www.infrico.com

IMPORTANT: Las bandejas deben contener producto previamente refrigerado.
IMPORTANT: The trays should contain previously refrigerated product.
IMPORTANT: Les plateaux doivent contenir des produits préalablement réfrigérés.

Refrigeración estática en la cuba
 Static cooling in the tank
 Refroidissement statique supérieur

BMGN 1960 EN



Granito
 Granite worktop
 Granit



MPG 1980

Granito
 Granite worktop
 Granit



ME 1003 VIP

[501X16] = 6



[501X13] = 1 [501X16] = 7



[501X13] = 1 [501X11] = 6



[501X13] = 1 [501X11] = 9

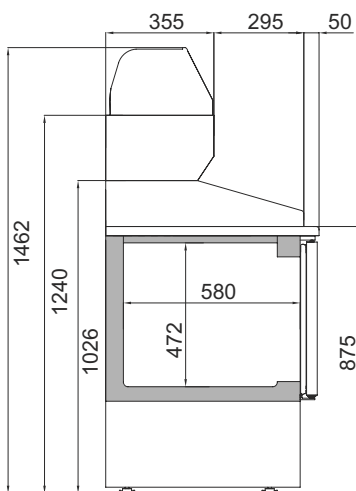

ME VIP

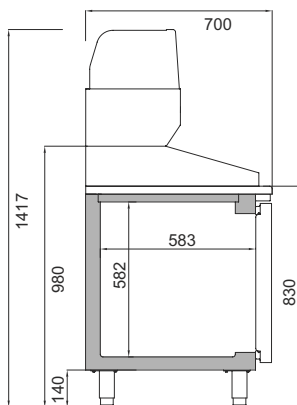



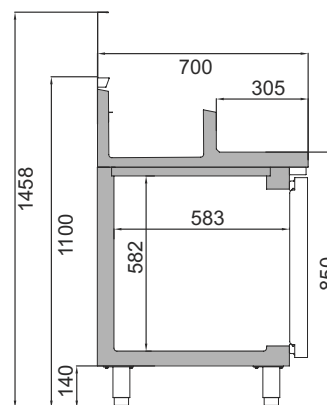

MPG



BMGN EN

Mesa refrigerada ensaladas / Salad prep refrigerator table / Desserte gastronomique positive préparation salades

MODELO MODELE MODÈLE					
	ME 1000 BAN	ME 1000 EN	ME 1000 II	ME 1000 PIZZA	ME 1000 KB
Precio Price Prix					
Medidas Measures [mm] Mesures	978 x 700 x 890 mm.	978 x 700 x 895/1050 mm.	978 x 700 x 895 mm.	978 x 700 x 875/1140 mm.	978 x 700 x 865/1125 mm.
Temperatura Temperature Température	0°C/+6°C.				
Clase Climática Climatic class Classe climatique	4 / 38°C				
Tensión/Frecuencia Electrical data Tension électrique	230V/1ph/50Hz				
Controlador Controller Régulateur	Digital IP65				
Material Material [EXT/INT] Matériel	Inox AISI 304				
Espesor Thickness Épaisseur	55				
Aislamiento Isolation Isolation	40kg/m ³ / Free CFC's / Zero ODP-GWP				
Capacidad Capacity Capacité	230				
Puertas Doors Portes	2				
Nº parrillas / Guías Nº shelves / Slides Nº de grilles / Glissière	2/6 (325x530)				
Sistema de frío Cooling System Système de froid	Ventilado / Forced air / Ventilé				
Desescarche Defrost Dégivrage	Parada compresor / Compressor off / Arrêt du compresseur				
Expansión Expansion Expansion	Capilar / Capillary / Capillaire				
Potencia Power Puissance	210				
Potencia frig. Cooling capacity Puissance Frig.	370				
Consumo Consumption Consommation	-				
Clase energética Energy class Classe Énerg.	-				
Refrigerante Refrigerant Gaz	R-290				
Opcional Optional Options	Juego de guías / Slides / Jeu de Glissières [GUIACO115530; GUIACO215530] Kit 2 cajones 1x1/2 + 1x1/3 (Modelo II) / Drawers kit 1x1/2 + 1x1/3 (Model II) Kit tiroirs 1x1/2 + 1x1/3 (Modèle II) [JCAJ17ME1/2] Puerta de cristal / Glass door / Porte vitrée [PUE17IDME10-PUE17IIME10]			Parrilla / Wire shelf / Grille [502X12] Cerradura / Lock / Serrure [506X120; 506X121] 115V/1ph/60Hz 230V/1ph/60Hz	
	[501X11] = 6 [501X10] = 3	[501X16] = 5	-	[501X11] = 3 [501X10] = 1	[501X11] = 6 [501X10] = 3

Serie / Series / Série **GN1/1 700**

+Info: www.infrico.com



[501X11] = 6 [501X10] = 3

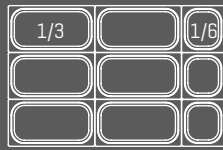

ME 1000 BAN



Opcional: Manejo control digital por WiFi o  Bluetooth®

Optional: Operating digital control by WiFi or  Bluetooth®



[501X16] = 5 

ME 1000 EN



Kit 2 cajones 1x1/2 + 1x1/3 [Modelo II] /
Drawers kit 1x1/2 + 1x1/3 [Model II]
Kit tiroirs 1x1/2 + 1x1/3 [Modèle II]
[JCAJ17ME1/2]

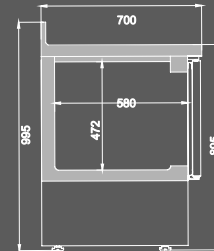

ME 1000 II



[501X11] = 3 [501X10] = 1 

ME 1000 PIZZA





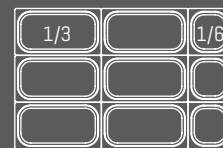

[501X11] = 6 [501X10] = 3



ME 1000 KB



Mesa refrigerada ensaladas / Salad prep refrigerator table / Desserte gastronomique positive préparation salades

MODELO MODELE MODÈLE					
	ME 1003 BAN	ME 1003 EN	ME 1003 II	ME 1003 PIZZA	ME 1003 KB
Precio Price Prix					
Medidas Measures [mm] Mesures	1460 x 700 x 890 mm.	1460 x 700 x 885/1050 mm.	1460 x 700 x 895 mm.	1460 x 700 x 875/1140 mm.	1460 x 700 x 865/1125 mm.
Temperatura Temperature Température	0°C/+6°C.				
Clase Climática Climatic class Classe climatique	4 / 38°C				
Tensión/Frecuencia Electrical data Tension électrique	230V/1ph/50Hz				
Controlador Controller Régulateur	Digital IP65				
Material Material [EXT/INT] Matériel	Inox AISI 304				
Espesor Thickness Épaisseur	40kg/m ³ / Free CFC's / Zero ODP-GWP				
Aislamiento Isolation Isolation	55				
Capacidad Capacity Capacité	355				
Puertas Doors Portes	3				
N° parrillas / Guías N° shelves / Slides N° de grilles / Glissière	3/9 [325x530]				
Sistema de frío Cooling System Système de froid	Ventilado / Forced air / Ventilé				
Desescarche Defrost Dégivrage	Parada compresor / Compressor off / Arrêt du compresseur				
Expansión Expansion Expansion	Capilar / Capillary / Capillaire				
Potencia Power Puissance	368				
Potencia frig. Cooling capacity Puissance Frig.	690				
Consumo Consumption Consommation	-				
Clase energética Energy class Classe Énerg.	-				
Refrigerante Refrigerant Gaz	R-290				
Opcional Optional Options	Juego de guías / Slides / Jeu de Glissières [GUIACO115530; GUIACO215530] Kit 2 cajones 1x1/2 + 1x1/3 [Modelo II] / Drawers kit 1x1/2 + 1x1/3 [Model II] Kit tiradores 1x1/2 + 1x1/3 [Modèle II] [JCAJ17ME1/2] Puerta de cristal / Glass door / Porte vitrée [PUE17IDME10-PUE17IIME10]			Parrilla / Wire shelf / Grille [502X12] Cerradura / Lock / Serrure [506X120; 506X121] 115V/1ph/60Hz 230V/1ph/60Hz	
	{501X11} = 9 {501X10} = 6	{501X16} = 8	-	{501X11} = 2 {501X10} = 4	{501X11} = 9 {501X10} = 6

Serie / Series / Série **GN1/1 700**

+Info: www.infrico.com



[501X11] = 9 [501X10] = 6

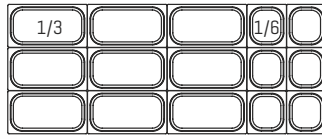

ME 1003 BAN

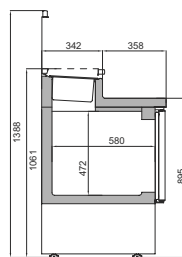

[501X16] = 8



ME 1003 EN



ME 1000 II



Kit 2 cajones 1x1/2 + 1x1/3 [Modelo II] /
 Drawers kit 1x1/2 + 1x1/3 [Model II]
 Kit tiroirs 1x1/2 + 1x1/3 [Modèle II]
 [JCAJ17ME1/2]

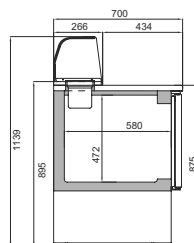

[501X11] = 2 [501X10] = 4



ME 1003 PIZZA



[501X11] = 9 [501X10] = 6

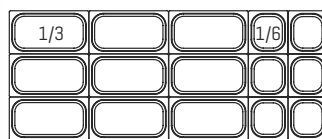





ME 1003 KB



Mesa refrigeración y congelación Euronorma 600x400 pastelería / Euronorm 600x400 refrigerator and freezer counter / Tour pâtissier positif et négatif Euronorme 600x400

EURONORM 600x400

MODELO MODELE MODÈLE					
	MR 1620	MR 2190	MR 2750	MR 1620 BT	MR 2190 BT
Precio Price Prix					
Medidas Measures [mm] Mesures	1618 x 800 x 850 mm.	2185 x 800 x 850 mm.	2752 x 800 x 850 mm.	1618 x 800 x 850 mm.	2185 x 800 x 850 mm.
Temperatura Temperature Température	-2°C/+8°C			-18°C	
Clase Climática Climatic class Classe climatique	5 / 40°C			4 / 38°C	
Tensión/Frecuencia Electrical data Tension électrique	230V/1ph/50Hz				
Controlador Controller Régulateur	Digital IP65				
Material Material [EXT/INT] Matériel	Inox AISI 304				
Espesor Thickness Épaisseur	70				
Aislamiento Isolation Isolation	40kg/m ³ / Free CFC's / Zero ODP-GWP				
Capacidad Capacity Capacité	420	635	850	420	635
Puertas Doors Portes	2	3	4	2	3
Nº parrillas / Guías Nº shelves / Slides Nº de grilles / Glissières	2/10 [600x400]	3/15 [600x400]	4/20 [600x400]	2/10 [600x400]	3/15 [600x400]
Sistema de frío Cooling System Système de froid	Monoblock ventilado / Forced air monoblock / Monoblock ventilé				
Desescarche Defrost Dégivrage	Parada compresor / Compressor off / Arrêt du compresseur			Gas caliente / Hot gas defrost / Gaz chaud	
Expansión Expansion Expansion	Capilar / Capillary / Capillaire			Válvula de expansión termostática / Thermostatic expansion valve / Détendeur thermostatique	
Potencia Power Puissance		368		568	712
Potencia frig. Cooling capacity Puissance Frig.		690		540	639
Consumo Consumption Consommation	1,67	2,07	3,06	6,03	11,15
Clase energética Energy class Classe Énerg.	A		B	C	D
Refrigerante Refrigerant Gaz	R-290				
Opcional Optional Options	Granito / Granite-top / Granit MR1620 [1618X800X30] [606X35] Granito / Granite-top / Granit MR2190 [2185X800X30] [606X36] Granito / Granite-top / Granit MR2750 [2752X800X30] [606X37] Bandeja Inox/ Stainless Steel Tray / Bac Inox 600x400 [A850P41] Cerradura / Lock / Serrure [506X209; 506X210]			Parrilla / Wire shelf / Grille [502X26] Juego de guías / Slides / Jeu de Glissières [GUIAL0120641, GUIAL0220641] Ruedas / Casters / Roulettes [705X16=2; 705X17=2] 115V/1ph/60Hz 230V/1ph/60Hz	

Serie / Series / Série **800**

+Info: www.infrico.com

MR 2750



MR 2190 BT

Opcional
Optional
Option

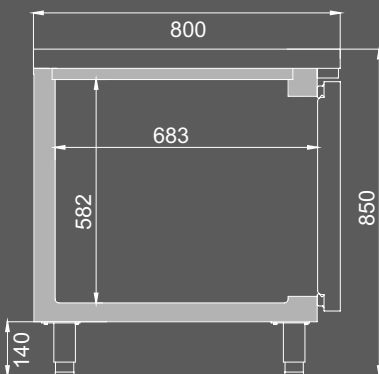

Frío Ventilado con efecto estático para pastelería profesional
Ventilated cooling with static effect for professional patisseries
Refroidissement ventilé avec effet statique pour les pâtisseries professionnelles

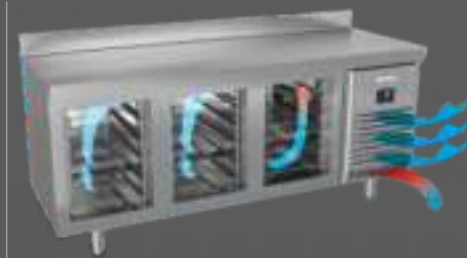



Opcional: Manejo control digital por WiFi o Bluetooth

Optional: Operating digital control by WiFi or Bluetooth



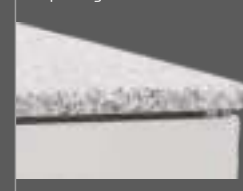



Opcional granito
Optional granite worktop
Option granite



Mesa refrigeración 600x400 puerta cristal / 600x400 glass door counter refrigerator / Tour pâtissier positif 600x400 porte vitrée

Mesa refrigeración 600x400 remota / 600x400 remote counter refrigerator / Tour pâtissier positif 600x400 groupe à distance

Grupo remoto / Remote / Groupe à distance

MODELO MODELE MODÈLE						
	MR 1620 CR	MR 2190 CR	MR 2750 CR	MR 1620 GR	MR 2190 GR	MR 2750 GR
Precio Price Prix						
Medidas Measures [mm] Mesures	1618 x 800 x 850 mm.	2185 x 800 x 850 mm.	2752 x 800 x 850 mm.	1390 x 800 x 850 mm.	1957 x 800 x 850 mm.	2524 x 800 x 850 mm.
Temperatura Temperature Température	+2°C/+6°C.			-2°C/+8°C.		
Clase Climática Climatic class Classe climatique	4 / 38°C.			5 / 40°C.		
Tensión/Frecuencia Electrical data Tension électrique	230V/1ph/50Hz					
Controlador Controller Régulateur	Digital IP65					
Material Material [EXT/INT] Matériel	Inox AISI 304					
Espesor Thickness Épaisseur	70					
Aislamiento Isolation Isolation	40kg/m ³ / Free CFC's / Zero ODP-GWP					
Capacidad Capacity Capacité	420	635	850	420	635	850
Puertas Doors Portes	2	3	4	2	3	4
Nº parrillas / Guías Nº shelves / Slides Nº de grilles / Glissière	2/10 (600x400)	3/15 (600x400)	4/20 (600x400)	2/10 (600x400)	3/15 (600x400)	4/20 (600x400)
Sistema de frío Cooling System Système de froid	Monoblock ventilado / Forced air monoblock / Monoblock ventilé			-		
Desescarche Defrost Dégivrage	Parada compresor / Compressor off / Arrêt du compresseur					
Expansión Expansion Expansion	Capilar / Capillary / Capillaire			Válvula expansión opcional [especificar refrig.] Expansion valve optional [specify refrigerant] Détendeur options [spécifier le gaz]		
Potencia Power Puissance	378	383	389	368		
Potencia frig. Cooling capacity Puissance Frig.	690			Recom. 690		
Consumo Consumption Consommation	-			-		
Clase energética Energy class Classe Énerg.	-			-		
Refrigerante Refrigerant Gaz	R-290			-		
Opcional Optional Options	Juego de guías / Slides / Jeu de Glissières [GUIAL0120641, GUIAL0220641]			115V/1ph/60Hz		230V/1ph/60Hz
	Parrilla doble tupida / Extradense wire shelf / Grille renforcée [502X64] Granito / Granite-top / Granit MR1620 [1618X800X30] [606X35] Granito / Granite-top / Granit MR2190 [2185X800X30] [606X36] Granito / Granite-top / Granit MR2750 [2752X800X30] [606X37] Cerradura / Lock / Serrure [506X60] Parrilla Inox / Stainless steel wire shelf / Grille inox [502X47] Bandeja Inox / Stainless Steel Tray / Bac Inox 600x400 [A850P41] Iluminación Led RGB con cambio de color [por puerta] / Led lighting RGB change of colour [per door] / LED RGB avec changement de couleur [par porte]			Parrilla / Wire shelf / Grille [502X26] Puerta de cristal / Glass door / Porte vitrée [PUE17IDMR-PUE17IIMR] Cerradura / Lock / Serrure [506X209; 506X210] Bandeja Inox / Stainless Steel Tray / Bac Inox 600x400 [A850P41] Válvula expansión opcional [especificar refrig.] Expansion valve optional [specify refrigerant] Détendeur options [spécifier le gaz]		

Serie / Series / Série **800**

+Info: www.infrico.com

MR 2190 CR



Posibilidad de acceso frontal y lateral para una mejor manipulación
 Front and lateral access for better handling
 Possibilité d'accès frontal et latéral pour une meilleure manipulation.

Aumentan en su largo 8 cm. para una mejor manipulación.
 They increase in their length 8 cm. for better handling.
 8 cm. de long en plus pour une meilleure manipulation.



MR 2190 GR

Doble cristal templado bajo emisivo más carga Argón 4-27-4
 Double tempered glass low-e + Argón 4-27-4
 Double vitrage trempé à faible émissivité avec Argón 4-27-4



Opcional granito
 Optional granite worktop
 Option granite

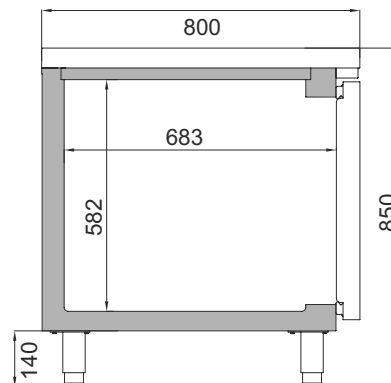

**Mesa refrigerada central
600x400 puerta dos caras /
600x400 pass thru counter refrigerator /
Tour pâtissier positif 600x400 traversante**

**Mesa refrigerada 600x400 para ensaladas,
pizza y pastelería / 600x400 salads, pizza and
pastry prep counter refrigerator / Table positive
600x400 préparation salades, pizzas et pâtisseries**

MODELO MODELE MODÈLE	EURONORM 600x400 Pasante/Pass-thru/Traversante				EURONORM 600x400 Ensalada, pizza y pastelería Salads, pizza & pastry Salade, pizza et pâtisserie	
	MR 1620 PDC	MR 2190 PDC	MR 1620 PDCR	MR 2190 PDCR	MR 1620 EN	MR 2190 EN
Precio Price Prix						
Medidas Measures [mm] Mesures	1618 x 800 x 850 mm.	2185 x 800 x 850 mm.	1618 x 800 x 850 mm.	2185 x 800 x 850 mm.	1618 x 800 x 850/1050 mm.	2185 x 800 x 850/1050 mm.
Temperatura Temperature Température	-2°C/+8°C			+2°C/+6°C		0°C/+6°C
Clase Climática Climatic class Classe climatique	5 / 40°C			4 / 38°C		4 / 38°C
Tensión/Frecuencia Electrical data Tension électrique	230V/1ph/50Hz					
Controlador Controller Régulateur	Digital IP65					
Material Material [EXT/INT] Matériel	Inox AISI 304					
Espesor Thickness Épaisseur	70					
Aislamiento Isolation Isolation	40kg/m ³ / Free CFC's / Zero ODP-GWP					
Capacidad Capacity Capacité	420	635	420	635	420+55	635+80
Puertas Doors Portes	4	6	4	6	2	3
Nº parrillas / Guías Nº shelves / Slides Nº de grilles / Glissières	2/10 {600x400}	3/15 {600x400}	2/10 {600x400}	3/15 {600x400}	2/10 {600x400}	3/15 {600x400}
Sistema de frío Cooling System Système de froid	Monoblock ventilado / Forced air monoblock / Monoblock ventilé					
Desescarche Defrost Dégivrage	Parada compresor / Compressor off / Arrêt du compresseur					
Expansión Expansion Expansion	Capilar / Capillary / Capillaire					
Potencia Power Puissance	368		387	398	368	
Potencia frig. Cooling capacity Puissance Frig.	690					
Consumo Consumption Consommation	1,67	2,07	-			
Clase energética Energy class Classe Énerg.	A		A		-	
Refrigerante Refrigerant Gaz	R-290					
	Parrilla / Wire shelf / Grille [502X26] Bandeja Inox/ Stainless Steel Tray / Bac Inox 600x400 [A850P41] Juego de guías / Slides / Jeu de Glissières [GUIAL0120641, GUIAL0220641]			Cerradura / Lock / Serrure [506X209; 506X210] 115V/1ph/60Hz 230V/1ph/60Hz		
Opcional Optional Options	Parrilla doble tupida / Extradense wire shelf / Grille renforcée [502X64] Granito / Granite-top / Granit MR1620 [1618X800X30] [606X35] Granito / Granite-top / Granit MR2190 [2185X800X30] [606X36] Cerradura / Lock / Serrure [506X60] [PDCR] Parrilla Inox / Stainless steel wire shelf / Grille inox [502X47]				Parrilla de trabajo / Garnish rack / Grille travail [PTMP] Ruedas / Casters / Roulettes [705X16=2; 705X17=2]	
					[501X16] = 9	[501X16] = 13

Serie / Series / Série 800

+Info: www.infrico.com

Opcional
Optional
Option

Pasante/Pass-thru/Traversante
MR 2190 PDC



Pasante/Pass-thru/Traversante
MR PDC

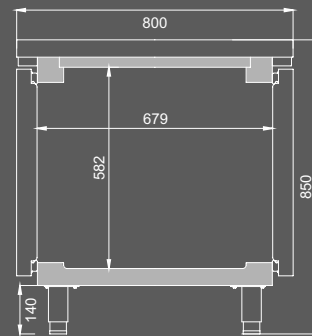

[501X16] = 9



[501X16] = 13

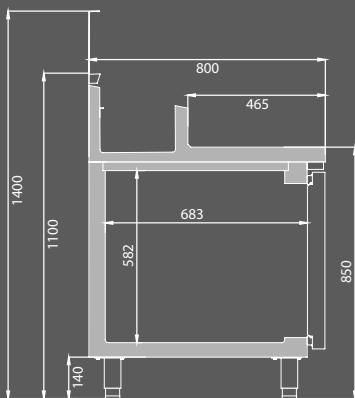

MR 1620 EN

Refrigeración estática en la cuba
Static cooling in the tank
Refroidissement statique



Mesa refrigerada ventilada con control de humedad / Ventilated refrigerated table with humidity control / Table réfrigérée ventilée avec contrôle de l'humidité

MODELO
MODELE
MODÈLE



MR 1620 H



MR 2190 H

	MR 1620 H	MR 2190 H
Precio Price Prix		
Medidas Measures [mm] Mesures	1618 x 800 x 850 mm.	2185 x 800 x 850 mm.
Temperatura Temperature Température	+2°C/+8°C	
Clase Climática Climatic class Classe climatique	Humedad / humidity / humidité 45% HR / 85% HR	
Tensión/Frecuencia Electrical data Tension électrique	230V/1ph/50Hz	
Controlador Controller Régulateur	Digital IP65 con control de humedad / Digital IP65 with humidity control / Digital IP65 avec contrôle de l'humidité	
Material Material [EXT/INT] Matériel	Inox AISI 304	
Espesor Thickness Épaisseur	70	
Aislamiento Isolation Isolation	40kg/m ³ / Free CFC's / Zero ODP-GWP	
Capacidad Capacity Capacité	420	635
Puertas Doors Portes	2	3
N° parrillas / Guías N° shelves / Slides N° de grilles / Glissière	2/10 [600x400]	3/15 [600x400]
Sistema de frío Cooling System Système de froid	Monoblock ventilado / Forced air monoblock / Monoblock ventilé	
Desescarche Defrost Dégivrage	Parada compresor / Compressor off / Arrêt du compresseur	
Expansión Expansion Expansion	Capilar / Capillary / Capillaire	
Potencia Power Puissance	868	
Potencia frig. Cooling capacity Puissance Frig.	690	
Consumo Consumption Consommation	-	-
Clase energética Energy class Classe Énerg.	-	
Refrigerante Refrigerant Gaz	R-290	
Opcional Optional Options	Granito / Granite-top / Granit MR1620 [1618X800X30] [606X35] Granito / Granite-top / Granit MR2190 [2185X800X30] [606X36] Bandeja Inox/ Stainless Steel Tray / Bac Inox 600x400 [A850P41] Cerradura / Lock / Serrure [506X209; 506X210]	Parrilla / Wire shelf / Grille [502X26] Juego de guías / Slides / Jeu de Glissières [GUIAL0120641, GUIAL0220641] Ruedas / Casters / Roulettes [705X16=2; 705X17=2] 115V/1ph/60Hz 230V/1ph/60Hz

NEW

Series / Série **MR H**

+Info: www.infrico.com

MR 1620 H



MR 2190 H

Control electrónico de Temperatura y Humedad
Electronic Temperature and Humidity control
Contrôle électronique de la Température et de l'humidité





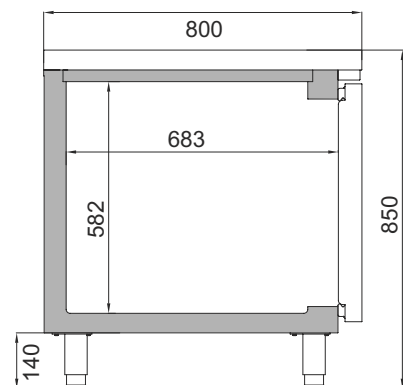



Opcional granito
Optional granite worktop
Option granite



Mesa refrigerada pizza Lucena / Pizza prep table Lucena / Table positive et fast food Lucena (MPL)

Mesa refrigerada pizza / Pizza prep table / Table positive pizza (MP)

MODELO MODELE MODÈLE						
	MPL 1740	MPL 2300	MP 1740	MP 2300	MP 1740 CN	MP 2300 CN
Precio Price Prix						
Medidas Measures [mm] Mesures	1693 x 800 x 850/1010 mm.	2260 x 800 x 850/1010 mm.	1738 x 800 x 830/980 mm.	2305 x 800 x 830/980 mm.	1738 x 800 x 830/980 mm.	2305 x 800 x 830/980 mm.
Temperatura Temperature Température	+2°C/+6°C					
Clase Climática Climatic class Classe climatique	4 / 38°C			5 / 40°C		
Tensión/Frecuencia Electrical data Tension électrique	230V/1ph/50Hz					
Controlador Controller Régulateur	Digital IP65					
Material Material [EXT/INT] Matériel	Inox AISI 304					
Espesor Thickness Épaisseur	55					
Aislamiento Isolation Isolation	40kg/m ³ / Free CFC's / Zero ODP-GWP					
Capacidad Capacity Capacité	485	700	485+48	700+70	[R] 235 [V] 48 [N] 175	[R] 485 [V] 70 [N] 175
Puertas Doors Portes	2	3	2	3	1 + Neutro	2 + Neutro
Nº parrillas / Guías N° shelves / Slides N° de grilles / Glissière	2/10 [600x400]	3/15 [600x400]	7 [600x400]	10 [600x400]	8 [600x400]	11 [600x400]
Sistema de frío Cooling System Système de froid	Ventilado / Forced air / Ventilé					
Desescarche Defrost Dégivrage	Parada compresor / Compressor off / Arrêt du compresseur					
Expansión Expansion Expansion	Capilar / Capillary / Capillaire					
Potencia Power Puissance		368		553	350	553
Potencia frig. Cooling capacity Puissance Frig.		690		690	370	690
Refrigerante Refrigerant Gaz	R-290					
Opcional Optional Options	Parrilla/Wire shelf/Grille [502X26] Juego de guías/Slides/Jeu de Glissières [GUAL0120641; GUAL0220641] Parrilla de trabajo / Garnish rack / Grille travail [PTMT] [MPL1740-3UD] [MPL2300-4UD] Cerradura / Lock / Serrure [506X209; 506X210] Ruedas / Casters / Roulettes [705X16=2; 705X17=2] 115V/1ph/60Hz 230V/1ph/60Hz		Parrilla/Wire shelf/Grille [502X26] Juego de guías/Slides/Jeu de Glissières [GUAL0120641; GUAL0220641] Opción neutro 6 cajones / Optional 6 drawers dry store / En option kit 6 tiroirs neutres [JCAJ17MP6] [Sólo / Only / Seulement MP2300CN] Contenedor polipropileno / Polypropylene container / Container polypropylène [501X08] Cerradura / Lock / Serrure [506X209; 506X210] 115V/1ph/60Hz 230V/1ph/60Hz			
	{501X14} = 1 {501X11} = 5 {501X10} = 4	{501X14} = 1 {501X11} = 8 {501X10} = 4	{501X13} = 1 {501X16} = 5	{501X13} = 1 {501X16} = 9	{501X13} = 1 {501X16} = 5	{501X13} = 1 {501X16} = 9

Serie / Series / Série 800

+Info: www.infrico.com

IMPORTANTE: Las bandejas deben contener producto previamente refrigerado.
IMPORTANT: The trays should contain previously refrigerated product.
IMPORTANT: Les plateaux doivent contenir des produits préalablement réfrigérés.

[501X14] = 1 [501X11] = 8 [501X10] = 4



[501X14] = 1 [501X11] = 5 [501X10] = 4

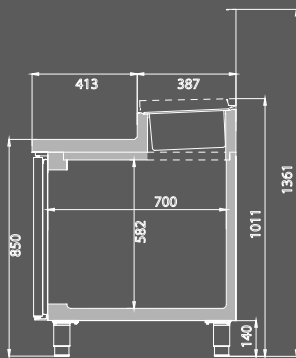

MPL 2300

Parrillas de trabajo
Garnish racks
Grilles de travail

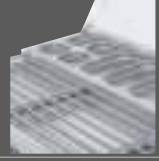

Cajón refrigerado de serie
Refrigerated drawer standard
Tiroir réfrigéré de série

[501X13] = 1 [501X16] = 9



[501X13] = 1 [501X16] = 5



Video del producto

Product Video
Vidéo du produit



Infrico Youtube

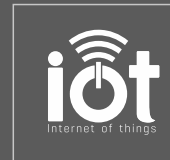

Opcional: Manejo control digital por WiFi o Bluetooth®
Optional: Operating digital control by WiFi or Bluetooth®



Vitrina de ingredientes incluida
Included ingredients display
De série vitrine avec couvercle vitré

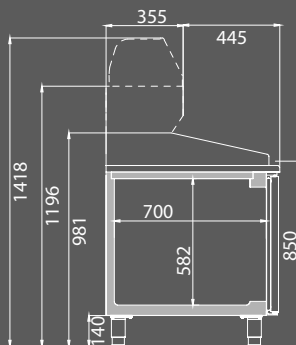

MP 2300 CN

Opcional kit neutro 6 cajones
Optional 6 neutral drawers
En option kit 6 tiroirs neutres



Cajón refrigerado de serie
Refrigerated drawer standard
Tiroir réfrigéré de série

Frente mostrador / Back-bar counter refrigerator / Desserte arrière bar positive cafétéria

Frente mostrador refrigerado preinstalado / Remote back-bar counter refrigerator / Desserte arrière bar groupe à distance cafétéria

MODELO MODELE MODÈLE	FMPP1500 II	FMPP2000 II	FMPP2500 II	FMPP1500 CR	FMPP2000 CR	FMPP2500 CR	FMPP1500 GR	FMPP2000 GR	FMPP2500 GR
Precio Price Prix									
Medidas Measures [mm] Mesures	1468 x 600 x 1050 mm.	1960 x 600 x 1050 mm.	2452 x 600 x 1050 mm.	1468 x 600 x 1050 mm.	1960 x 600 x 1050 mm.	2452 x 600 x 1050 mm.	1240 x 600 x 1050 mm.	1732 x 600 x 1050 mm.	2224 x 600 x 1050 mm.
Temperatura Temperature Température	-2°C/+8°C			+2°C/+6°C			0°C/+6°C		
Clase Climática Climatic class Classe climatique	5 / 40°C			4 / 38°C			-		
Tensión/Frecuencia Electrical data Tension électrique	230V/1ph/50Hz								
Controlador Controller Régulateur	Digital IP65								
Material Material [EXT/INT] Matériel	Inox AISI 304								
Espesor Thickness Épaisseur	70								
Aislamiento Isolation Isolation	40kg/m ³ / Free CFC's / Zero ODP-GWP								
Capacidad Capacity Capacité	340	520	690	340	520	690	340	520	690
Puertas Doors Portes	2	3	4	2	3	4	2	3	4
Nº parrillas / Guías Nº shelves / Slides Nº de grilles / Glissière	4/4 [325x430]	6/6 [325x430]	8/8 [325x430]	4/4 [325x430]	6/6 [325x430]	8/8 [325x430]	4/4 [325x430]	6/6 [325x430]	8/8 [325x430]
Sistema de frío Cooling System Système de froid	Monoblock ventilado / Forced air monoblock / Monoblock ventilé						-		
Desescarche Defrost Dégivrage	Parada compresor / Compressor off / Arrêt du compresseur								
Expansión Expansion Expansion	Capilar / Capillary / Capillaire						Válvula expansión opcional (especificar refrigerante) Expansion valve optional (specify refrigerant) Détendeur options (spécifier le gaz)		
Potencia Power Puissance	209	308		377	382	387	-		
Potencia frig. Cooling capacity Puissance Frig.	370	690				Recom. 370		Recom. 690	
Consumo Consumption Consommation	1,55	2,06	2,35	-					
Clase energética Energy class Classe Énerg.	A	A	A	-					
Refrigerante Refrigerant Gaz	R-290								
Opcional Optional Options	Juego de guías / Slides / Jeu de Glissières [GUIAC0115430, GUIAC0215430]			Parrilla doble tupida / Extradense wire shelf / Grille renforcée [502X43]			Parrilla / Wire shelf / Grille [502X07]		
	Parrilla inoxidable / Stainless steel wire shelf / Grille Inox [502X49]			Cerradura / Lock / Serrure [506X209; 506X210]			Cerradura / Lock / Serrure [506X60] [Mod. CR]		
	Iluminación Led RGB con cambio de color (por puerta) / Led lighting RGB change of colour (per door) / LED RGB avec changement de couleur (par porte)			115V/1ph/60Hz			230V/1ph/60Hz		
	Kit cajones / Drawer Kit / Kit tiroirs FM 350 + FM 250 [JCAJ17FM3525] BM 2 x 1/2x200 + 1 x 1/3x100 [JCAJ17FM1/2] BM 2/3 x 300 [JCAJ17FM2/3]			-			Kit cajones / Drawer Kit / Kit tiroirs FM 350 + FM 250 [JCAJ17FM3525] BM 2 x 1/2x200 + 1 x 1/3x100 [JCAJ17FM1/2] BM 2/3 x 300 [JCAJ17FM2/3]		
	Tolva / Coffe grounds hopper / Tiroir marc à café [TOL17FM] Grupo lado contrario / Group opposite side / Groupe opposé [L]						Válvula expansión opcional (especificar refrigerante) Expansion valve optional (specify refrigerant) Détendeur options (spécifier le gaz)		

Serie / Series / Série **600**

+Info: www.infrico.com

FMPP 2000 GR



Posibilidad de acceso frontal y lateral para una mejor manipulación.
Front and lateral access for better handling.
Possibilité d'accès frontal et latéral pour une meilleur manipulation.

FMPP 2000 CR



Tolva Opcional
Coffe grounds hopper Optional
Tiroir marc à café Options

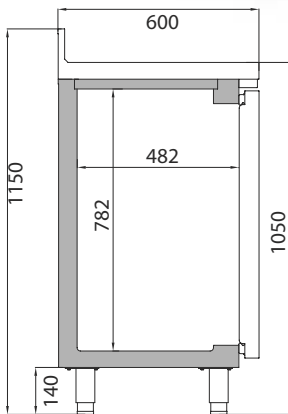

FM 250 302 x 418 x 255	1/3 302 x 418 x 105	
FM 350 302 x 418 x 352	1/2 302 x 418 x 205	2/3 302 x 418 x 307



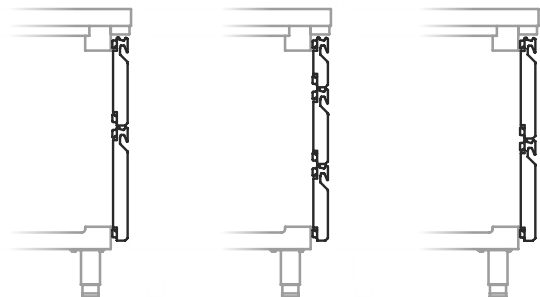



Kit 2 cajones 2 drawers kit Kit 2 tiroirs	Kit 3 cajones 3 drawers kit Kit 3 tiroirs	Kit 2 cajones 2 drawers kit Kit 2 tiroirs
FM 350 + FM 250	2 x BM 1/2 x 200 1 x BM 1/3 x 100	BM 2 x 2/3 x 300



KIT CAJONES / DRAWERS KIT / KIT TIROIRS (MOD. II - GR)

Mueble mesa cafetera / Coffe unit / Meuble caf  teria

Serie / Series / S  rie **MCAF**

MODELO MODELE MOD��LE						
Precio Price Prix						
Medidas Measures Mesures [mm]	820 x 600 x 1050 mm.	1000 x 600 x 1050 mm.	1000 x 600 x 1050 mm.	1468 x 600 x 1050 mm.	1960 x 600 x 1050 mm.	2450 x 600 x 1050 mm.
Material Material Mat��riel [EXT/INT]	Inox AISI 304					
Opcional Optional Options	Posibilidad de fabricar a medida sin modificar fondo ni cuerpo central. Possibility of custom-made manufacturing without modifying the depth or central body. Possibilit�� de fabriquer sur mesure sans modifier ni la profondeur ni la partie centrale.					



Mueble estantería y mesa de trabajo /
Shelf unit and working table /
Meuble étagère et table de travail

+Info: www.infrico.com

Serie / Series / Série ME / MT

MUEBLE ESTANTERÍA / SHELF UNIT / MEUBLE ÉTAGÈRE

MODELO MODELE MODÈLE								
Precio Price Prix								
Medidas Measures (mm) Mesures	1000 x 300 x 1050mm.	1468 x 300 x 1050mm.	1960 x 300 x 1050mm.	2452 x 300 x 1050mm.	1000 x 600 x 1050mm.	1468 x 600 x 1050mm.	1960 x 600 x 1050mm.	2452 x 600 x 1050mm.
MESA DE TRABAJO / WORKING TABLE / TABLE DE TRAVAIL								
MODELO MODELE MODÈLE								
Precio Price Prix								
Medidas Measures (mm) Mesures	1000 x 600 x 850mm.	1500 x 600 x 850mm.	2000 x 600 x 850mm.	1000 x 700 x 850mm.	1500 x 700 x 850mm.	2000 x 700 x 850mm.		
Material Material [EXT/INT] Matériel	Inox AISI 304							
Optional Options	Cajón auxiliar / Additional drawer / Tiroir 600 [CAJMT60] Cajón auxiliar / Additional drawer / Tiroir 700 [CAJMT70] Incremento peto mural / Increase for splash blak / Supplément dossieret mod. 1000 Incremento peto mural / Increase for splash blak / Supplément dossieret mod. 1500 Incremento peto mural / Increase for splash blak / Supplément dossieret mod. 2000 Modelos ME / ME Models / Modèles ME: Medidas especiales consultar con fábrica / Special length measurements consult our factory / Dimensions spéciales en longueur consulter l'usine.							



ME 30/2000

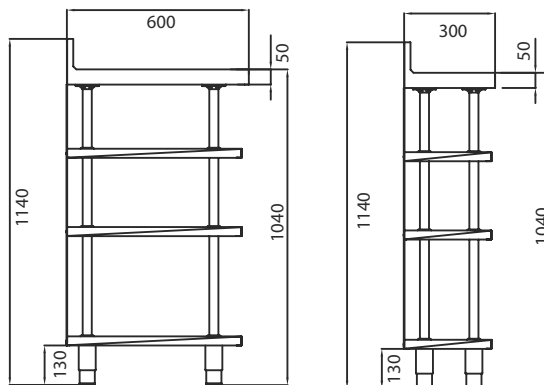

MT 60/1500

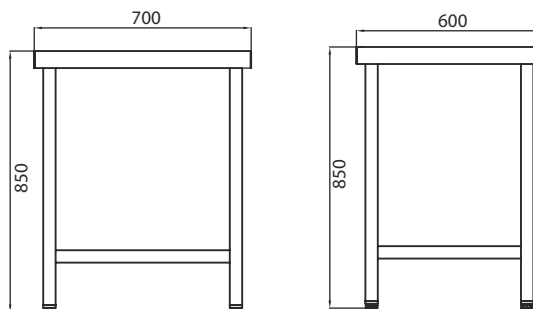

3

3. Armarios

Reach Ins / Armoires





3. Armarios

Reach Ins / Armoires



+Info: www.infrico.com



3. Armarios Reach Ins / Armoires

Controlador digital táctil e intuitivo IP 65.

Digital control easy and intuitive-touch screen IP65 protection.

Contrôleur digital tactile e intuitif IP 65.



Doble acristalamiento templado, bajo emisor con carga de Argón [4-27-4].

Double tempered glass, low-e with argon charge [4-27-4].

Double vitrage et verre trempé [4-27-4].



Iluminación / Lighting / Éclairage

Incorporación de iluminación LED, llegando a reducir el consumo energético entre un 80% y 90%, respecto a una bombilla tradicional. RGB opcional.

LED lighting incorporated, reducing energetic consumption between 80% and 90% respect to a traditional lighth bulb. RGB optional.

Éclairage LED, réduisant la consommation énergétique entre 80% et 90%, par rapport à une ampoule traditionnelle. RGB optionnel.



+Info: www.infrico.com

Puertas con tirador de doble agarre y burlete plano desmontable "cleanless".
 Double handle doors and flat gasket easily removable "cleanless".
 Portes avec double poignée et joint plat facilement démontable "cleanless".



Opcional: Manejo del control digital por WiFi o  Bluetooth*

Optional: Operating digital control by WiFi or  Bluetooth*

Optionnel: Fonctionnement de la commande numérique par WiFi ou  Bluetooth*

Opcional: Pata marina

Optional: Marine leg

Optionnel: Pied marin

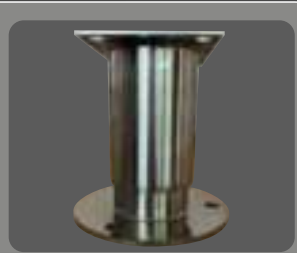

3. Armarios Reach Ins / Armoires

Serie / Series / Série

NACIONAL 400/900L	Armario de refrigeración Euronorm 600 x 400 Euronorm 600 x 400 reach in refrigerator / Armoire positive Euronorme 600 x 400	106 - 107
	Armario de congelación Euronorm 600 x 400 Euronorm 600 x 400 reach in freezer / Armoire négative Euronorme 600 x 400	106 - 107
	Armario de refrigeración pastelería Euronorm 600 x 400 Euronorm 600 x 400 pastry refrigerator reach in / Armoire positive pâtisserie Euronorme 600 x 400	106 - 107

Serie / Series / Série

AP 400/900L	Armario de refrigeración pescado Euronorm 600 x 400 Euronorm 600 x 400 reach in refrigerator for fish / Armoire positive à poisson Euronorme 600 x 400	108 - 109
------------------------	--	------------------

Serie / Series / Série

NACIONAL 500/1000L	Armario de refrigeración Bottom mounted reach in refrigerator / Armoire positive	110 - 111
	Armario de congelación Bottom mounted reach in freezer / Armoire négative	110 - 111
	Armario de refrigeración y congelación Bottom mounted reach in refrigerator / Armoire positive et négative	110 - 111
	Armario de congelación / Armario Mixto Bottom mounted reach in freezer & dual temp / Armoire négative / Armoire Mixte	112 - 113
	Armario de refrigeración dep. pescado o baja temperatura Bottom mounted fish or freezing compartment reach in / Armoire positive à poisson ou basse température	112 - 113
	Armario expositor refrigerado Bottom mounted glass door reach in refrigerator / Armoire exposition positive porte vitrée	114 - 115
	Armario expositor congelación Bottom mounted freezer glass door reach in / Armoire exposition négative porte vitrée	114 - 115

Serie / Series / Série

NACIONAL 1600L	Armario de refrigeración Bottom mounted refrigerator / Armoire positive	116 - 117
---------------------------	---	------------------

Serie / Series / Série

SLIM LINE 300/600L	Armario de refrigeración GN 1/1 GN 1/1 reach in refrigerator / Armoire positive GN 1/1	162 - 117
	Armario de congelación GN 1/1 GN 1/1 reach in freezer / Armoire négative GN 1/1	118 - 119
	Armario de refrigeración GN 1/1 GN 1/1 reach in refrigerator / Armoire positive GN 1/1	118 - 119

Serie / Series / Série

SLIM LINE AGN 300/600L	Armario de refrigeración puerta de cristal GN 1/1 GN 1/1 glass door reach in refrigerator / Armoire positive porte vitrée GN 1/1	118 - 119
-----------------------------------	--	------------------

+Info: www.infrico.com

Serie / Series / Série

**NACIONAL
400/900L**



AN401 T/F AN902 T/F AN904 T/F | AN401 BT AN902 BT
REFRIG/REFRIG/POSIT | CONGEL / FREEZ / NÉGAT

Serie / Series / Série

**NACIONAL
400/900L
PAST**



AN401 PAST AN902 PAST AN401 BT PAST AN902 BT PAST
PASTELERÍA/PASTRY/PÂTISSERIE | PASTELERÍA/PASTRY/PÂTISSERIE

Serie / Series / Série

**AP
400/900L**



AP401 T/F AP902 T/F
PESCADO / FISH / POISSON

Serie / Series / Série

**NACIONAL
500/1000L**



AN501 T/F AN1002 T/F AN501 BT AN1002 BT | AN502 T/F AN1003 T/F AN1004 T/F
REFRIG/REFRIG/POSIT | CONGEL / FREEZ / NÉGAT | REFRIG-CONGEL / REFRIG-FREEZER / POSIT-NÉGATIVE



AN502 BT AN1003 BT AN1004 BT | AN502 MX AN1002 MX | ANDP1003 TF/G ANDP1004 TF/G ANDBT1003 TF ANDBT1004 TF
CONGELACIÓN / FREEZER / NÉGATIVE | MIXTO / DUAL TEMP / MIXTE | PESCADO / FISH / POISSON



AEX500 T/F AEX1000 T/F AEX1600 T/F | AN501 BT CR AN1002 BT CR
REFRIGERACIÓN / REFRIGERATOR / POSITIVE | CONGELACIÓN / FREEZER / NÉGATIVE

Serie / Series / Série

**NACIONAL
1600L**



AN1603 T/F AN1605 T/F AN1606 T/F
REFRIGERACIÓN / REFRIGERATOR / POSITIVE

Serie / Series / Série

**SLIM LINE
300/600L**



AGN301 AGN602
REFRIG/REFRIG/POSITIVO

Serie / Series / Série

**SLIM LINE
300/600L**



AGN301 BT AGN602 BT AGN602 MX | AGN302 AGN603 AGN604
CONGELACIÓN / FREEZER / NÉGATIVE | REFRIG/REFRIG/POSITIVO

Serie / Series / Série

**SLIM LINE
300/600L**



AGN300 CR AGN600 CR
REFRIG/REFRIG/POSIT

3. Armarios

Reach Ins / Armoires

Serie / Series / Série		
AGB 600/1300L	Armario de refrigeración y congelación GN 2/1 GN 2/1 refrigerator and freezer reach in / Armoire positive et négative GN 2/1	120 - 121
Serie / Series / Série		
AGB 700/1400L	Armario de refrigeración y congelación GN 2/1 GN 2/1 refrigerator and freezer reach in / Armoire positive et négative GN 2/1	122 - 123
	Armario mixto GN 2/1 GN 2/1 dual temp reach in / Armoire mixte GN 2/1	122 - 123
	Armario de refrigeración y congelación puertas de cristal GN 2/1 Glass door reach in refrigerator and freezer / Armoire positive et négative porte vitrée GN 2/1	124 - 125
	Armario de refrigeración pescado 600 x 400 Fish refrigerator reach in / Armoire positive 600 x 400 poisson	124 - 125
	Armario de refrigeración Euronorm 600 x 400 pastelería Pastry reach in refrigerator / Armoire positive Euronorme 600 x 400 pâtisserie	126 - 127
Serie / Series / Série		
AGB A 700 L	Armario de refrigeración GN 2/1 Clase A Inverter GN 2/1 refrigerator reach in / Armoire positive GN 2/1 Classe A	126 - 127
Serie / Series / Série		
AGB 900L	Armario de refrigeración y congelación 800x600 heladería pastelería Euronorm Euronorm pastry ice cream 800x600 reach in refrigerator an freezer Armoire positive et négative glace et pâtisserie Euronorme 800x600	128 - 129
Serie / Series / Série		
AC600L	Armario catering Catering reach in reach in / Armoire traiteur catering	128 - 129
Serie / Series / Série		
AGB 900L	Armario de fermentación Retarder proofer cabinet / Armoire de fermentation	130 - 131
Serie / Series / Série		
RIC	Armario para carros GN 2/1 600x400, 650x450, 1300/2700L. GN 2/1 600x400, 650x450, 800x600, 1300/ 2700 L. Roll-in Armoire à chariot GN 2/1 600x400, 650x450, 1300/2700L.	132 - 133

+Info: www.infrico.com

Serie / Series / Série

**AGB
600/1300L**



AGB651 AGB651 BT AGB1302 AGB1302 BT
REFRIG-CONGEL / REFRIG-FREEZER / POSIT-NÉGATIVE

Serie / Series / Série

**AGB
A 700 L**



AGB 701 A
REFRIG/REFRIG/POSIT

Serie / Series / Série

**AGB
700/1400L**



AGB701 AGB701 BT AGB1402 AGB1402 BT AGB702 AGB702 BT AGB1403 AGB1404
REFRIGERACIÓN-CONGELACIÓN / REFRIGERATOR-FREEZER / POSITIVE-NÉGATIVE



AGN702 MX AGB1402 MX | AGB701 CR AGB701 BT CR AGB1402 CR AGB1402 BT CR | AGB701 PESC AGB1402 PESC
MIXTO/DUAL TEMP/MIXTE | REFRIG-CONGEL / REFRIG-FREEZER / POSIT-NÉGATIVE | PESCADO / FISH / POISSON



AGB701 PAST AGB701 BT PAST AGB1402 PAST AGB1402 BT PAST
PASTELERÍA / PASTRY / PÂTISSERIE

Serie / Series / Série

**AGB
900L**



AGB901BT AGB901
HELAD-PASTEL/ICE CR-PAST/ GLACE-PÂTIS

Serie / Series / Série

**FC
900 BT**

NEW



FC900BT
FERMENT / RETARDER PROOFER / FERMENT

NEW



FC900BT CR
FERMENT / RETARDER PROOFER / FERMENT

Serie / Series / Série

**AC
600L**



AC600 R AC600 BT
CÁTERING / CATERING / CATERING

Serie / Series / Série

RIC

NEW



NEW



NEW



RIC1P RIC1P TH RIC2P
CARROS / ROLL-IN / CHARIOT

Armarios de refrigeración y congelación Euronorm 600x400 / Euronorm 600x400 reach in refrigerator and freezer / Armoire Euronorme 600x400 positive et négative

REFRIG / REFRIG / POSIT

CONGEL / FREEZ / NÉGAT

MODELO
MODELE
MODÈLE



	AN 401 T/F	AN 902 T/F	AN 904 T/F	AN 401 BT	AN 902 BT
Precio Price Prix					
Medidas Measures [mm] Mesures	557 x 775 x 2060	1124 x 775 x 2060	1124 x 775 x 2060	557 x 775 x 2060	1124 x 775 x 2060
Temperatura Temperature Température	-2°C/+8°C			-18°C	
Clase Climática Climatic class Classe climatique	5 / 40°C			4 / 38°C	
Tensión/Frecuencia Electrical data Tension électrique	230V/1ph/50Hz				
Controlador Controller Régulateur	Digital IP65				
Material Material [EXT/INT] Matériel	AISI 304				
Espesor Thickness Épaisseur	55				
Aislamiento Isolation Isolation	40kg/m ³ / Free CFC's / Zero ODP-GWP				
Capacidad Capacity Capacité	395	895	895	395	895
Puertas Doors Portes	1	2	4	1	2
N° parrillas / Guías N° shelves / Slides N° de grilles / Glissière	3/3 [600x400]	6/6 [600x400]		3/3 [600x400]	6/6 [600x400]
Sistema de frío Cooling System Système de froid	Forzado / Forced air / Ventilé				
Desescarche Defrost Dégivrage	Parada de compresor / Compressor off / Arrêt du compresseur			Gas caliente / Hot gas / Gaz chaud	
Expansión Expansion Expansion	Capilar / Capillary / Capillaire			Válvula termostática / Expansion valve / Détendeur thermostatique	
Potencia Power Puissance	250	410		607	771
Potencia frig. Cooling capacity Puissance Frig.	370	690		540	720
Consumo Consumption Consommation	1,55	1,90		5,10	9,51
Clase energética Energy class Classe Énerg.	C	B		D	
Refrigerante Refrigerant Gaz	R-290				
Opcional Optional Options	Parrilla / Wire shelf / Grille [502X26] Juego de guías / Slides / Jeu de Glissières [GUIAL0120595; GUIAL0220595] Cerradura / Lock / Serrure [506X209; 506X210] Manejo control digital por bluetooth/ Operating digital control by bluetooth / Trait. de contrôle digital par bluetooth 115V/1ph/60Hz 230V/1ph/60Hz				

Serie / Series / Série **NACIONAL 400/900L**

+Info: www.infrico.com

AN 904 T/F



AN 401 T/F



AN 902 BT

Controlador digital IP 65.
Digital control IP65
Contrôleur digital IP 65.

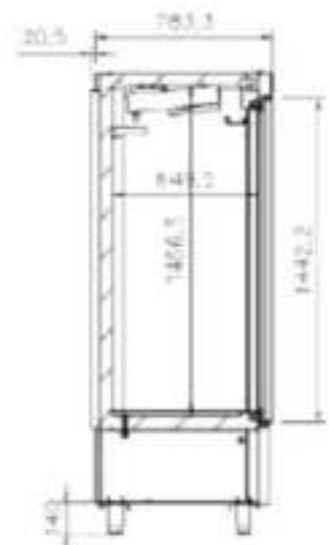

Armarios de refrigeración y congelación Pastelería y Pescado Euronorm 600x400 / Pastry and Fish Euronorm 600x400 reach in refrigerator and freezer / Armoire Euronorme 600x400 positive et négative pour la Pâtisserie et le Poisson

	PASTELERÍA / PASTRY / PÂTISSERIE				PESCADO / FISH / POISSON	
MODELO MODELE MODÈLE	AN 401 PAST	AN 902 PAST	AN 401 BT PAST	AN 902 BT PAST	AP 401 T/F	AP 902 T/F
Precio Price Prix						
Medidas Measures [mm] Mesures	557 x 775 x 2060	1124 x 775 x 2060	557 x 775 x 2060	1124 x 775 x 2060	557 x 775 x 2060	1124 x 775 x 2060
Temperatura Temperature Température	-2°C/+8°C		-18°C		-2°C/+2°C	
Clase Climática Climatic class Classe climatique	5 / 40°C		4 / 38°C		5 / 40°C	
Tensión/Frecuencia Electrical data Tension électrique	230V/1ph/50Hz					
Controlador Controller Régulateur	Digital IP65					
Material Material [EXT/INT] Matériel	AISI 304					
Espesor Thickness Épaisseur	55					
Aislamiento Isolation Isolation	40kg/m ³ / Free CFC's / Zero ODP-GWP					
Capacidad Capacity Capacité	395	895	395	895	395	895
Puertas Doors Portes	1	2	1	2	1	2
N° parrillas / Guías N° shelves / Slides N° de grilles / Glissière	0/18	0/36	0/18	0/36	7	14
Sistema de frío Cooling System Système de froid	Forzado / Forced air / Ventilé					
Desescarche Defrost Dégivrage	Parada de compresor / Compresor off / Arrêt du compresseur		Gas caliente / Hot gas / Gaz chaud		Parada de compresor / Compresor off / Arrêt du compresseur	
Expansión Expansion Expansion	Capilar / Capillary / Capillaire		Válvula termostática / Expansion valve / Détendeur thermostatique		Capilar / Capillary / Capillaire	
Potencia Power Puissance	250	410	607	771	250	410
Potencia frig. Cooling capacity Puissance Frig.	370	690	540	720	370	690
Consumo Consumption Consommation	1,55	1,90	5,10	9,51	1,55	1,90
Clase energética Energy class Classe Énerg.	C	B	D		C	B
Refrigerante Refrigerant Gaz	R-290					
Opcional Optional Options	Parrilla / Wire shelf / Grille [502X26] Juego de guías / Slides / Jeu de Glissières [GUIAL0120595; GUIAL0220595] Cerradura / Lock / Serrure [506X209; 506X210] Manejo control digital por bluetooth / Operating digital control by bluetooth / Trait. de contrôle digital par bluetooth 115V/1ph/60Hz 230V/1ph/60Hz					Contenedor polipropileno / Polypropylene container / Container polypropylène [501X08]
	Bandeja / Tray / Plateau 600x400 [A850P41]					

NEW

Series / Série **NACIONAL 400/900L**
Series / Série **AP T/F**

+Info: www.infrico.com

AP 401 T/F



Contenedor polipropileno
Polypropylene container
Container polypropylène

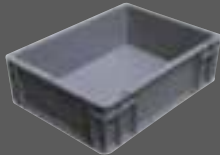

600mm x 400mm x 150mm

AN 902 PAST



Bandeja pastelería [opcional]
Pasty tray [optional]
Plateau Pâtisserie [optionnel]

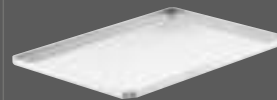

AN 400 PAST



Opcional: Manejo control digital por WiFi o Bluetooth®
Optional: Operating digital control by WiFi or Bluetooth®

Controlador digital IP 65.
Digital control IP65
Contrôleur digital IP 65.

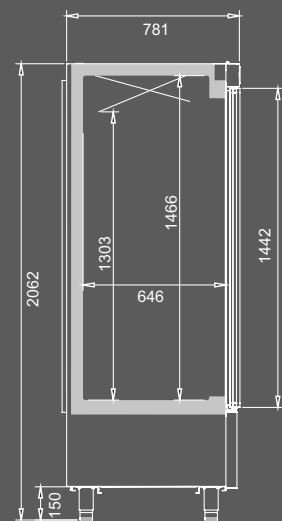

Armarios de refrigeración y congelación / Reach in refrigerator and freezer / Armoire positive et négative

	REFRIG / REFRIG / POSIT		CONGEL / FREEZ / NÉGAT		REFRIG-CONGEL / REFRIG-FREEZER / POSIT-NÉGATIVE		
MODELO MODELE MODÈLE	AN 501 T/F	AN 1002 T/F	AN 501 BT	AN 1002 BT	AN 502 T/F	AN 1003 T/F	AN 1004 T/F
Precio Price Prix							
Medidas Measures [mm] Mesures	687 x 700 x 2060	1385 x 700 x 2060	687 x 700 x 2060	1385 x 700 x 2060	687 x 700 x 2060	1385 x 700 x 2060	1385 x 700 x 2060
Temperatura Temperature Température	-2°C/+8°C		-18°C		-2°C/+8°C		
Clase Climática Climatic class Classe climatique	5 / 40°C		4 / 38°C		5 / 40°C		
Tensión/Frecuencia Electrical data Tension électrique	230V/1ph/50Hz						
Controlador Controller Régulateur	Digital IP65						
Material Material [EXT/INT] Matériel	AISI 304						
Espesor Thickness Épaisseur	55						
Aislamiento Isolation Isolation	40kg/m ³ / Free CFC's / Zero ODP-GWP						
Capacidad Capacity Capacité	500	1110	500	1110	500	1110	1110
Puertas Doors Portes	1	2	1	2	2	3	4
N° parrillas / Guías N° shelves / Slides N° de grilles / Glissière	3/3 [530x460]	6/6 [530x510]	3/3 [530x460]	6/6 [530x510]	3/3 [530x460]	6/6 [530x510]	6/6 [530x510]
Sistema de frío Cooling System Système de froid	Forzado / Forced air / Ventilé						
Desescarche Defrost Dégivrage	Parada de compresor / Compresor off / Arrêt du compresseur		Gas caliente / Hot gas / Gaz chaud		Parada de compresor / Compresor off / Arrêt du compresseur		
Expansión Expansion Expansion	Capilar / Capillary / Capillaire			Válv. Expansión/ Expansion valve/ Valve d'expansion	Capilar / Capillary / Capillaire		
Potencia Power Puissance	250	415	610	795	250	420	
Potencia frig. Cooling capacity Puissance Frig.	370	690	540	720	370	690	
Consumo Consumption Consommation	1,45	2,53	5,72	10,70	1,45	2,53	
Clase energética Energy class Classe Énerg.	C	B	D		C	B	
Refrigerante Refrigerant Gaz	R-290						
Opcional Optional Options	Parrilla / Wire shelf / Grille AN 500 [502X04] Parrilla / Wire shelf / Grille AN 1000 [502X02] Juego de guías / Slides AN 500 [GUIACO315470] Juego de guías / Slides GUIACO115520; GUIACO215520 Barra carnicera / Meat bar set / Barre à viande [BCAN]			Cerradura / Lock / Serrure Manejo control digital wifi / Operating digital control wifi / Trait. de contrôle digital wifi 115V/1ph/60Hz 230V/1ph/60Hz			
	Ruedas / Casters / Roulettes [705X16=2; 705X17=2]						

Serie / Series / Série **NACIONAL 500/1000L**

+Info: www.infrico.com

AN 1003 T/F



AN 501 BT



AN 1002 T/F

Nuevo Controlador digital IP 65.
New Digital control IP65
Contrôleur digital IP 65.

 **Bluetooth® Incluido / Included**



Bisagra reforzada
Reinforced hinge
Charnière renforcée

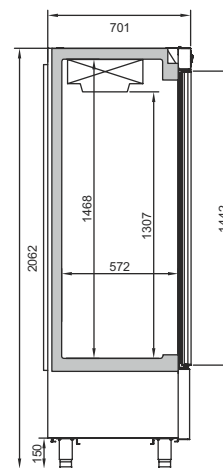

Armarios de refrigeración, congelación y mixtos / Reach in refrigerator, freezer and dual temperature / Armoires positives, négatives et mixtes

CONGELACIÓN / FREEZER / NÉGATIVE

MIXTO / DUAL TEMP / MIXTE

PESCADO / FISH / POISSON

MODELO
MODELE
MODÈLE



AN502 BT

AN1003 BT

AN1004 BT

AN502 MX

AN1002 MX

ANDP1003 TF/G

ANDP1004 TF/G

ANDBT1003 TF

ANDBT1004 TF

Precio Price Prix									
Medidas Measures [mm] Mesures	687 x 700 x 2060	1385 x 700 x 2060	1385 x 700 x 2060	687 x 700 x 2060	1385 x 700 x 2060	1385 x 700 x 2060	1385 x 700 x 2060	1385 x 700 x 2060	1385 x 700 x 2060
Temperatura Temperature Température	-18°C			-2°C/+8°C -18°C		-2°C/+8°C -2°C/+2°C		-2°C/+8°C -18°C	
Clase Climática Climatic class Classe climatique	4 / 38°C					5 / 40°C		4 / 38°C	
Tensión/Frecuencia Electrical data Tension électrique	230V/1ph/50Hz								
Controlador Controller Régulateur	Digital IP65								
Material Material [EXT/INT] Matériel	AISI 304								
Espesor Thickness Épaisseur	55								
Aislamiento Isolation Isolation	40kg/m ³ / Free CFC's / Zero ODP-GWP								
Capacidad Capacity Capacité	500	1110		240/240	540/540	245/855			
Puertas Doors Portes	2	3	4	2		3	4	3	4
N° parrillas / Guías N° shelves / Slides N° de grillas / Glissière	3/3 [530x460]	6/6 [530x510]	6/6 [530x510]	3/3 [530x460]	6/6 [530x510]	3 Cont. 4 Parr./Shel./Gril.		6 Parr./Shel./Gril.	
Sistema de frío Cooling System Système de froid	Forzado / Forced air / Ventilé								
Desescarche Defrost Dégivrage	Gas caliente / Hot gas / Gaz chaud			Parada comp(+)/Gas caliente(-) Compresor off(+)/Hot gas(-) Arrêt compres(+)/Gaz chaud(-)		Parada de compresor / Compresor off / Arrêt du compresseur		Parada comp(+)/Gas caliente(-) Compresor off(+)/Hot gas(-) Arrêt compres(+)/Gaz chaud(-)	
Expansión Expansion Expansion	Capilar / Capillary / Capillaire	Válv. Expansión/ Expansion valve/ Détendeur thermostatique		Capilar / Capillary / Capillaire					
Potencia Power Puissance	610	795		1003	1090	589		1050	
Potencia frig. Cooling capacity Puissance Frig.	540	720		370 / 445	370 / 540	690 / 370		690 / 445	
Consumo Consumption Consommation	5,72	10,70		4,84	7,91	-	-	-	-
Clase energética Energy class Classe Énerg.	D								
Refrigerante Refrigerant Gaz	R-290								
Opcional Optional Options	Parrilla / Wire shelf / Grille AN 500 [502X04] Parrilla / Wire shelf / Grille AN 1000 [502X02] Juego de guías / Slides AN 500 [GUIACO315470] Juego de guías / Slides AN 1000 [GUIACO115520; GUIACO215520] Barra carnicera / Meat bar set / Barre à viande [BCAN]				Cerradura / Lock / Serrure Manejo control digital wifi / Operating digital control wifi / Trait. de contrôle digital wifi 115V/1ph/60Hz 230V/1ph/60Hz Ruedas / Casters / Roulettes [705X16=2; 705X17=2]				

Serie / Series / Série **NACIONAL 500/1000L**

+Info: www.infrico.com

AN 1003 BT



 **Bluetooth®**
Incluido / Included



ANDP 1004 TF/G 

De serie: 3 contenedores de polipropileno en departamento de pescado
Standard: 3 polypropylene containers in fish department
Standard : 3 conteneurs en polypropylène au rayon poisson

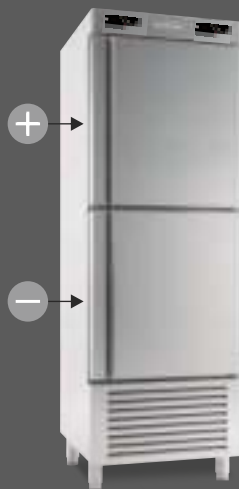

AN 502 MX

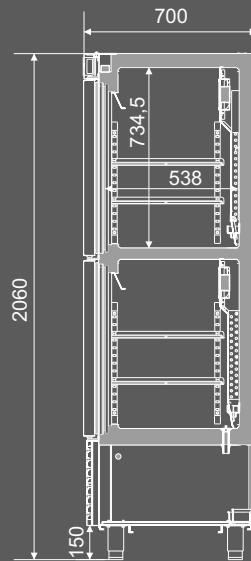

Armarios expositores refrigeración y congelación / Bottom mounted refrigerator and freezer glass door reach in / Armoires positives et négatives portes vitrées

REFRIGERACIÓN / REFRIGERATOR / POSITIVE

CONGELACIÓN / FREEZER / NÉGATIVE



MODELO
MODELE
MODÈLE

AEX500 T/F

AEX1000 T/F

AEX1600 T/F

AN501 BT CR

AN1002 BT CR

Precio Price Prix					
Medidas Measures [mm] Mesures	687 x 700 x 2060 mm.	1385 x 700 x 2060 mm.	2081 x 700 x 2060 mm.	687 x 700 x 2060 mm.	1385 x 700 x 2060 mm.
Temperatura Temperature Température	+2°C/+6°C			-18°C	
Clase Climática Climatic class Classe climatique	4 / 38°C				
Tensión/Frecuencia Electrical data Tension électrique	230V/1ph/50Hz				
Controlador Controller Régulateur	Digital IP65				
Material Material [EXT/INT] Matériel	AISI 304				
Espesor Thickness Épaisseur	55				
Aislamiento Isolation Isolation	40kg/m ³ / Free CFC's / Zero ODP-GWP				
Capacidad Capacity Capacité	500	1110	1730	500	1110
Puertas Doors Portes	1	2	3	1	2
N° parrillas / Guías N° shelves / Slides N° de grilles / Glissière	4/4 [530x460]	8/8 [530x510]	12/12 [530x510]	4/4 [530x460]	8/8 [530x510]
Consumo Consumption Consommation [kWh/ 24h]	-	-	-	8,60	16,05
Sistema de frío Cooling System Système de froid	Forzado / Forced air / Ventilé				
Desescarche Defrost Dégivrage	Parada de compresor / Compressor off / Arrêt du compresseur			Gas caliente / Hot gas / Gaz chaud	
Expansión Expansion Expansion	Capilar / Capillary / Capillaire			Válvula de Expansión Termostática / Thermostatic expansion valve / Valve d'expansion Thermostatique	
Potencia Power Puissance	270	455	615	755	1130
Potencia frig. Cooling capacity Puissance Frig. [-10°C]	390	690	950	723	1010
Refrigerante Refrigerant Gaz	R-290				
Opcional Optional Options	115V/1ph/60Hz 230V/1ph/60Hz Juego de guías / Slides AN 500 [GUIACO315470] Juego de guías / Slides AN 1000 [GUIACO115520; GUIACO215520] Parrilla doble tupida / Dense wire shelf / Grilles AN 500 [502X90] Parrilla doble tupida / Dense wire shelf / Grilles AN 1000 [502X89] Cerradura / Lock / Serrure [506X60] Manejo control digital wifi / Operating digital control wifi / Trait. de contrôle digital wifi Iluminación Led RGB con cambio de color [por puerta] / Led lighting RGB change of colour [per door] / LED RGB avec changement de couleur [par porte]				

Serie / Series / Série **NACIONAL 500/1000L**

+Info: www.infrico.com

AEX 1000 T/F

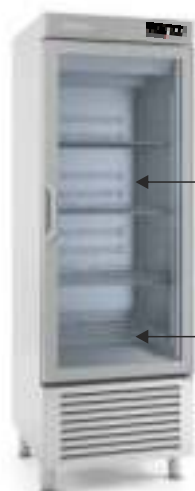

AN 501 BT CR

Triple acristalamiento templado, bajo emisivo con carga de Argón [4-12-3-12-4]
Triple tempered glass, low emission with Argon charge [4-12-3-12-4]
Triple vitrage trempé à faible émissivité avec Argon [4-12-3-12-4]

Parrilla reforzada
Reinforced shelves
Grille renforcée



Nuevo Controlador digital IP 65.
New Digital control IP65
Contrôleur digital IP 65.

Bluetooth® Incluido / Included

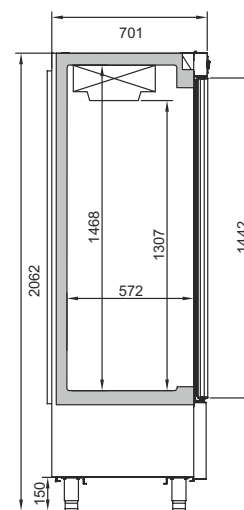

Armario de refrigeración / Bottom mounted refrigerator / Armoire positive

Armario de refrigeración GN1/1 / GN1/1 Reach in refrigerator / Armoire positive GN1/1

Serie / Series / Série **NACIONAL 1600L**Serie / Series / Série **SLIM LINE 300/600L**

MODELO
MODELE
MODÈLE

AN1603 T/F

AN1605 T/F

AN1606 T/F

AGN301

AGN602

Precio Price Prix					
Medidas Measures [mm] Mesures	↔ ↕	2081 x 700 x 2060 mm.	2081 x 700 x 2060 mm.	2081 x 700 x 2060 mm.	482 x 695 x 2100 mm.
Temperatura Temperature Température	[°C]	-2°C/+8°C			-2°C/+8°C
Clase Climática Climatic class Classe climatique	[°C]	5 / 40°C			5 / 40°C
Tensión/Frecuencia Electrical data Tension électrique		230V/1ph/50Hz			
Controlador Controller Régulateur		Digital IP65			
Material Material [EXT/INT] Matériel		AISI 304			
Espesor Thickness Épaisseur	[mm]	55			
Aislamiento Isolation Isolation	[mm]	40kg/m ³ / Free CFC's / Zero ODP-GWP			
Capacidad Capacity Capacité	[L]	1730			325
Puertas Doors Portes		3	5	6	1
N° parrillas / Guías N° shelves / Slides N° de grilles / Glissière		9/9 (530x510)			3/3 (325x530)
Sistema de frío Cooling System Système de froid		Forzado / Forced air / Ventilé			
Desescarche Defrost Dégivrage		Parada de compresor / Compresor off / Arrêt du compresseur			
Expansión Expansion Expansion		Capilar / Capillary / Capillaire			
Potencia Power Puissance	[W]	420			237
Potencia frig. Cooling capacity Puissance Frig.	[W A -10°C]	690			370
Consumo Consumption Consommation	[kWh/ 24h]	3,60			1,40
Clase energética Energy class Classe Énerg.		B			C
Refrigerante Refrigerant Gaz		R-290			
Opcional Optional Options		Juego de guías / Slides / Jeu de Glissières [GUIAC0115520; GUIAC0215520] Cerradura / Lock / Serrure [506X209; 506X210]		115V/1ph/60Hz 230V/1ph/60Hz	
		Manejo control digital bluetooth o wifi / Operating digital control bluetooth or wifi / Trait. de contrôle digital bluetooth ou wifi		Ruedas/Casters/Roulettes [705X16=2; 705X17=2]	
		Parrilla / Wire shelf / Grille AN 1600 [502X04] Barra carnicera / Meat bar set / Barre à viande [BCAN]		Parrilla / Wire shelf / Grille [502X12]	

Serie / Series / Série **NACIONAL 1600L**
 Serie / Series / Série **SLIM LINE 300/600L**

+Info: www.infrico.com



AN 1606 T/F

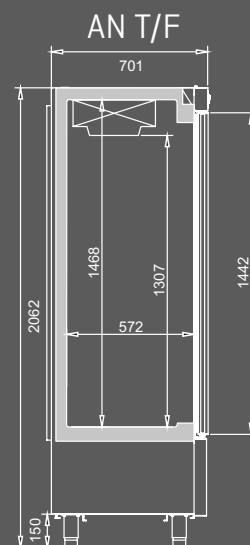

Nuevo Controlador digital IP 65.
 New Digital control IP65
 Contrôleur digital IP 65.

 **Bluetooth®**
Incluido / Included



AGN 301



AGN 602

Controlador digital IP 65.
 Digital control IP65
 Contrôleur digital IP 65.



Opcional: Manejo control digital por WiFi o  Bluetooth®
 Optional: Operating digital control by WiFi or  Bluetooth®

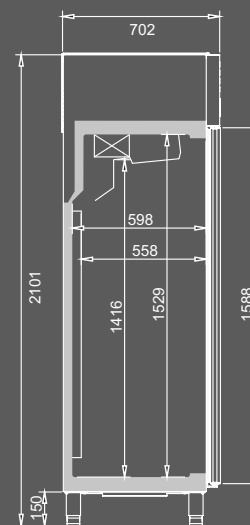

Armarios de refrigeración y congelación GN1/1 / GN1/1 Refrigerator and freezer reach in / Armoires positives et négatives GN1/1

	CONGELACIÓN / FREEZER / NÉGATIVE			REFRIGERACIÓN / REFRIGERATOR / POSITIVE			REFRIG/REFRIG/POSIT	
MODELO MODELE MODÈLE	AGN301 BT	AGN602 BT	AGN602 MX	AGN302	AGN603	AGN604	AGN300 CR	AGN600 CR
Precio Price Prix								
Medidas Measures [mm] Mesures	482 x 695 x 2100 mm.	974 x 695 x 2100 mm.	974 x 695 x 2100 mm.	482 x 695 x 2100 mm.	974 x 695 x 2100 mm.	974 x 695 x 2100 mm.	482 x 695 x 2100 mm.	974 x 695 x 2100 mm.
Temperatura Temperature Température [°C]	-18°C		-2°C/+8°C -18°C	-2°C/+8°C			+2°C/+6°C	
Clase Climática Climatic class Classe climatique [°C]	4 / 38°C			5 / 40°C			4 / 38°C	
Tensión/Frecuencia Electrical data Tension électrique	230V/1ph/50Hz							
Controlador Controller Régulateur	Digital IP65							
Material Material [EXT/INT] Matériel	AISI 304							
Espesor Thickness Épaisseur [mm]	55							
Aislamiento Isolation Isolation [mm]	40kg/m ³ / Free CFC's / Zero ODP-GWP							
Capacidad Capacity Capacité [L]	325	745	325+325	325	745		325	745
Puertas Doors Portes	1	2		2	3	4	1	2
Nº parrillas / Guías Nº shelves / Slides Nº de grilles / Glissière	3/3 (325x530)	6/6 (325x530)		3/3 (325x530)	6/6 (325x530)		4/4 (325x530)	8/8 (325x530)
Sistema de frío Cooling System Système de froid	Forzado / Forced air / Ventilé							
Desescarche Defrost Dégivrage	Gas caliente / Hot gas / Gaz chaud		Parada comp(+)/Gas caliente(-) Compresor off(+)/Hot gas(-) Arrêt compres(+)/Gaz chaud(-)	Parada de compresor / Compresor off / Arrêt du compresseur				
Expansión Expansion Expansion	Válv. Expansión/ Expansion valve/ Détendeur thermostatique		Capilar(+)/ V. Exp(-) Cap(+)/ Exp. valve(-) Cap(+)/ V. d'exp(-)	Capilar / Capillary / Capillaire				
Potencia Power Puissance [W]	550	725	772	237	406		252	456
Potencia frig. Cooling capacity Puissance Frig. [W A -10°C]	445	720	370 / 445	370	690		370	690
Consumo Consumption Consommation [kWh/ 24h]	4,83	9,22	-	1,40	1,85		-	
Clase energética Energy class Classe Énerg.	D		-	C			-	
Refrigerante Refrigerant Gaz	R-290							
Opcional Optional Options	Manejo control digital bluetooth o wifi / Operating digital control bluetooth or wifi / Trait. de contrôle digital bluetooth ou wifi			Juego de guías / Slides / Jeu de Glissières (GUIACO115550; GUIACO215550)			115V/1ph/60Hz 230V/1ph/60Hz	
	Parrilla / Wire shelf / Grille (502X12) Ruedas / Casters / Roulettes (705X16=2; 705X17=2) Cerradura / Lock / Serrure (506X209; 506X210)			Parrilla inoxidable / Stainless steel wire shelf / Grille Inox (502X46) Cerradura / Lock / Serrure (506X209; 506X210) Parrilla tupida / Extradense wire shelf / Grille renforcée (502X62) Ruedas / Casters / Roulettes (705X16=2; 705X17=2)			Parrilla tupida / Extradense wire shelf / Grille renforcée (502X62) Parrilla inox / Stainless steel wire shelf / Grille Inox (502X46) Cerradura/Lock/Serrure (506X60) Iluminación Led RGB con cambio de color (por puerta) / Led lighting RGB change of colour (per door) / LED RGB avec changement de couleur (par porte)	

Serie / Series / Série **SLIM LINE 300/600L**

+Info: www.infrico.com

AGN 301 BT



AGN 604



AGN 600 CR

Doble acristalamiento templado, bajo emisivo con carga de Argón [4-27-4]
 Double tempered glass, low emission with Argon charge [4-27-4]
 Double vitrage trempé à faible émissivité avec Argon [4-27-4]

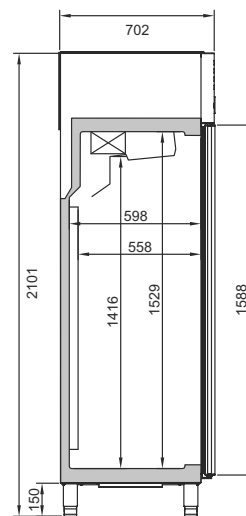

Armarios de refrigeración y congelación GN2/1 / GN2/1 Refrigerator and freezer reach in / Armoires positives et négatives GN2/1



AGB651



AGB1302



AGB651 BT



AGB1302 BT

MODELO MODELE MODÈLE	AGB651	AGB1302	AGB651 BT	AGB1302 BT
Precio Price Prix				
Medidas Measures [mm] Mesures	687 x 794 x 1989 mm.	1385 x 794 x 1989 mm.	687 x 794 x 1989 mm.	1385 x 794 x 1989 mm.
Temperatura Temperature Température	-2°C/+8°C		-18°C	
Clase Climática Climatic class Classe climatique	5 / 40°C		4 / 38°C	
Tensión/Frecuencia Electrical data Tension électrique	230V/1ph/50Hz			
Controlador Controller Régulateur	Digital IP65			
Material Material [EXT/INT] Matériel	AISI 304			
Espesor Thickness Épaisseur	75			
Aislamiento Isolation Isolation	40kg/m ³ / Free CFC's / Zero ODP-GWP			
Capacidad Capacity Capacité	505	1120	505	1120
Puertas Doors Portes	1	2	1	2
Nº parrillas / Guías Nº shelves / Slides Nº de grilles / Glissière	3 [530x650]	6 [530x650]	3 [530x650]	6 [530x650]
Sistema de frío Cooling System Système de froid	MONOBLOCK Forzado / Forced air / Ventilé			
Desescarche Defrost Dégivrage	Parada compres./ Compresor off/ Arrêt compres.		Gas caliente / Hot gas / Gaz chaud	
Expansión Expansion Expansion	Capilar/ Capillary / Capillaire		Válv. Expansión/ Expansion valve/ Détendeur thermostatique	
Potencia Power Puissance	210	374	664	1054
Potencia frig. Cooling capacity Puissance Frig.	370	690	583	1010
Consumo Consumption Consommation	1,41	2,40	7,12	13,11
Clase energética Energy class Classe Énerg.	C	C	D	D
Refrigerante Refrigerant Gaz	R-290			
Opcional Optional Options	<p>Manejo control digital bluetooth o wifi/ Operating digital control bluetooth or wifi / Trait. de contrôle digital bluetooth ou wifi</p> <p>Parrilla tupida / Extradense wire shelf / Grille renforcée [502X91]</p> <p>Ruedas / Casters / Roulettes [705X16=2; 705X17=2]</p> <p>115V/1ph/60Hz</p> <p>230V/1ph/60Hz</p>			

Serie / Series / Série **AGB 600/1300L**

+Info: www.infrico.com

AGB 1302 BT



Medida para pasar bajo puertas estándar
Measurement to pass under standard doors
Mesure pour passer sous les portes standard

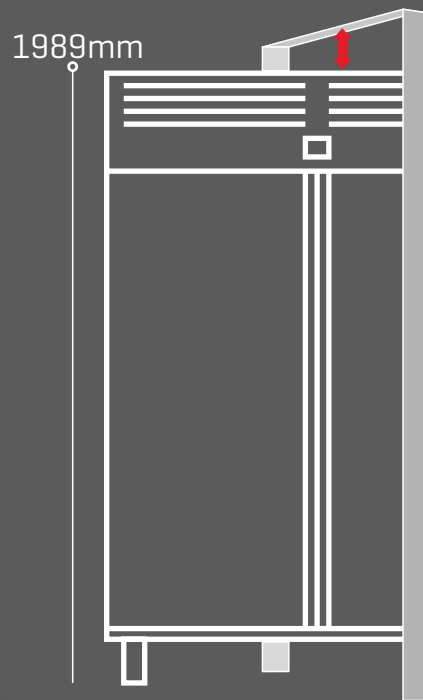

Cerradura de serie
Door lock included
Serrure de série

Costados con guías embutidas
End pannels with embedded rails
Joues avec rails emboutis



Monoblock

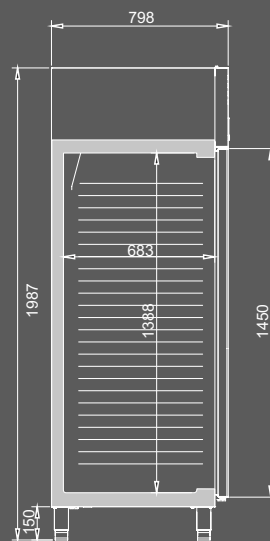

AGB 651

Armarios de refrigeración y congelación GN2/1 / GN2/1 Refrigerator and freezer reach in / Armoires positives et négatives GN2/1

REFRIGERACIÓN-CONGELACIÓN / REFRIGERATOR-FREEZER / POSITIVE-NÉGATIVE

MODELO MODELE MODÈLE	AGB701	AGB1402	AGB701 BT	AGB1402 BT	AGB702	AGB702 BT	AGB1403	AGB1404
Precio Price Prix								
Medidas Measures [mm] Mesures	687 x 794 x 2130 mm.	1385 x 794 x 2130 mm.	687 x 794 x 2130 mm.	1385 x 794 x 2130 mm.	687 x 794 x 2130 mm.	687 x 794 x 2130 mm.	1385 x 794 x 2130 mm.	1385 x 794 x 2130 mm.
Temperatura Temperature Température	-2°C/+8°C		-18°C		-2°C/+8°C		-18°C	
Clase Climática Climatic class Classe climatique	5 / 40°C		4 / 38°C		5 / 40°C		4 / 38°C	
Tensión/Frecuencia Electrical data Tension électrique	230V/1ph/50Hz							
Controlador Controller Régulateur	Digital IP65							
Material Material [EXT/INT] Matériel	AISI 304							
Espesor Thickness Épaisseur	75							
Aislamiento Isolation Isolation	40kg/m ³ / Free CFC's / Zero ODP-GWP							
Capacidad Capacity Capacité	560	1240	560	1240	560		1240	
Puertas Doors Portes	1	2	1	2	2		3	4
N° parrillas / Guías N° shelves / Slides N° de grilles / Glissière	3 [530x650]	6 [530x650]	3 [530x650]	6 [530x650]	3 [530x650]		6 [530x650]	
Sistema de frío Cooling System Système de froid	MONOBLOCK Forzado / Forced air / Ventilé							
Desescarche Defrost Dégivrage	Parada compres./ Compresor off/ Arrêt compres.		Gas caliente / Hot gas / Gaz chaud		Parada compres./ Compresor off/ Arrêt compres.		Gas caliente / Hot gas / Gaz chaud	
Expansión Expansion Expansion	Capilar/ Capillary / Capillaire		Válv. Expansión/ Expansion valve/ Détendeur thermostatique		Capilar/ Capillary / Capillaire		Válv. exp. Termostát./ Thermost. exp. valve/ Détendeur thermos.	
Potencia Power Puissance	210	374	664	1054	210	664	371	
Potencia fríg. Cooling capacity Puissance Frig.	370	690	583	1010	370	583	690	
Consumo Consumption Consommation	1,54	2,55	7,80	13,92	1,54	7,80	2,55	
Clase energética Energy class Classe Énerg.	C	B	D		C	D	B	
Refrigerante Refrigerant Gaz	R-290							
Opcional Optional Options	Parrilla tupida / Extradense wire shelf / Grille renforcée [502X91] Barra carnicera / Meat bar set / Barre à viande [BCAN] Ruedas / Casters / Roulettes [705X16=2; 705X17=2] Manejo control digital bluetooth o wifi / Operating digital control bluetooth or wifi / Trait. de contrôle digital bluetooth ou wifi 115V/1ph/60Hz 230V/1ph/60Hz							

Serie / Series / Série **AGB 700/1400L**

+Info: www.infrico.com

AGB 1404



AGB 701



AGB 702 BT

 <p>Internet of things</p>	<p>Opcional: Manejo control digital por WiFi o  Bluetooth*</p>	<p>Optional: Operating digital control by WiFi or  Bluetooth*</p>
	<p><i>(Note: The original image contains a small image of a control panel, but it is not explicitly labeled in this block.)</i></p>	



Monoblock



Costados embutidos
Stamped inner sides
Intérieurs emboutis



Parrillas reforzadas
Reinforced wire shelves
Grilles renforcées

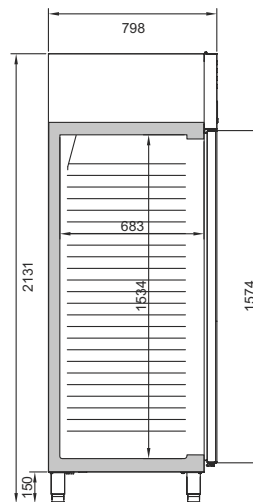

Armarios de refriger. congel. y mixtos GN2/1 / GN2/1 Refrig, freezer and dual temp. reach in / Armoires positives, négatives et mixtes GN2/1

Armarios de refriger. pescado 600x400 / 600x400 Fish refrigerator reach in / Armoire positives 600x400 poisson

MIXTO / DUAL TEMP / MIXTE

REFRIG-CONGEL / REFRIG-FREEZER / POSIT-NÉGATIVE

PESCADO / FISH / POISSON



MODELO
MODELE
MODÈLE

AGN702 MX

AGB1402 MX

AGB701 CR

AGB1402 CR

AGB701 BT CR

AGB1402 BT CR

AGB701 PESC

AGB1402 PESC

Precio Price Prix										
Medidas Measures [mm] Mesures	687 x 794 x 2130 mm.	1385 x 794 x 2130 mm.	687 x 794 x 2130 mm.	1385 x 794 x 2130 mm.	687 x 794 x 2130 mm.	1385 x 794 x 2130 mm.	687 x 794 x 2130 mm.	1385 x 794 x 2130 mm.		
Temperatura Temperature Température	-2°C/+8°C -18°C		-2°C/+6°C		-18°C		-2°C/+2°C			
Clase Climática Climatic class Classe climatique	4 / 38°C						5 / 40°C			
Tensión/Frecuencia Electrical data Tension électrique	230V/1ph/50Hz									
Controlador Controller Régulateur	Digital IP65									
Material Material [EXT/INT] Matériel	AISI 304									
Espesor Thickness Épaisseur	75									
Aislamiento Isolation Isolation	40kg/m ³ / Free CFC's / Zero ODP-GWP									
Capacidad Capacity Capacité	260/260	560/560	560	1240	560	1240	560	1240		
Puertas Doors Portes	2	2	1	2	1	2	1	2		
Nº parrillas / Guías Nº shelves / Slides Nº de grilles / Glissière	3 [530x650]	6 [530x650]	4 [530x650]	8 [530x650]	4 [530x650]	8 [530x650]	Nº contenedores / Containers 7	Nº contenedores / Containers 14		
Sistema de frío Cooling System Système de froid	Forzado / Forced air / Ventilé	MONOBLOCK Forzado / Forced air / Ventilé								
Desescarche Defrost Dégivrage	Parada compres. (+) Gas caliente (-) Compressor off (+) Hot gas (-) Arrêt compres. (+) Gaz chaud (-)	Parada de compresor / Compressor off / Arrêt du compresseur		Gas caliente / Hot gas / Gaz chaud		Parada compres./ Compressor off / Arrêt compres.				
Expansión Expansion Expansion	Capilar(+), V. Exp(-) Cap(+), Exp. valve(-) Cap(+), Dét. Th(-)	Capilar / Capillary / Capillaire				Válv. Expansión/ Expansion valve/ Détendeur thermostatique		Capilar/ Capillary / Capillaire		
Potencia Power Puissance	680	910	372	420	699	1550	210	374		
Potencia frig. Cooling capacity Puissance Frig.	370 / 445	370 / 583	690		723	1446	370	690		
Consumo Consumption Consommation							-	1,54	2,55	
Clase energética Energy class Classe Énerg.							-	C	B	
Refrigerante Refrigerant Gaz	R-290									
Opcional Optional Options	Manejo control digital bluetooth o wifi / Operating digital control bluetooth or wifi / Trait. de contrôle digital bluetooth ou wifi Ruedas / Casters / Roulettes [705X16=2; 705X17=2]					115V/1ph/60Hz 230V/1ph/60Hz				
	Parrilla / Wire shelf / Grille [502X91] Ruedas / Casters / Roulettes [705X16=2; 705X17=2] Juego de guías / Slides [GUIAL0320603] Barra carnicera / Meat bar set / Barre à viande [BCAN]			Parrilla / Wire shelf / Grille [502X91] Parrilla inoxidable / Stainless steel wire shelf / Grille Inox [502X58] Iluminación Led RGB con cambio de color [por puerta] / Led lighting RGB change of colour [per door] / LED RGB avec changement de couleur [par porte]			Juego de guías / Slides / Jeu de Glissières [GUIAL0125641; GUIAL0225641] Contenedor polipropileno / Polypropylene container / Conteneur de polypropylène [501X08] [501X08]			

Serie / Series / Série **AGB 700/1400L**

+Info: www.infrico.com

AGB 1402 BT CR



Controlador digital IP 65.
Digital control IP65
Contrôleur digital IP 65.



Parrillas reforzadas
Reinforced shelves
Grilles renforcées

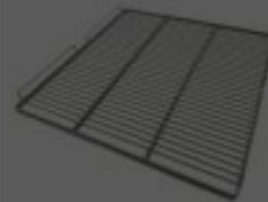

Triple acristalamiento templado,
bajo emisor con carga de Argón
(4-12-3-12-4)

Triple tempered glass, low
emission with Argon charge
(4-12-3-12-4)

Triple vitrage trempé à faible
émissivité avec Argon
(4-12-3-12-4)



Contenedor polipropileno
Polypropylene container
Conteneur de polypropylène

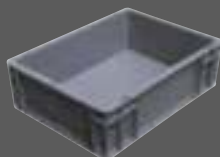

600mm x 400mm x 150mm

AGB PESC

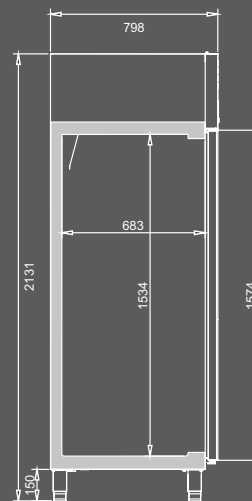

AGB 701 PESC



Armario refrig. GN2/1

GN2/1 refrigerator reach in /
Armoire posit. GN2/1

Armario refrig. Euronorm 600x400 Pastelería /

Euronorm 600x400 pastry reach in refig. /
Armoire posit. Euronorme 600x400 pâtisserie

AGB 700L INVERTER

PASTELERÍA / PASTRY / PÂTISSERIE



MODELO
MODELE
MODÈLE

AGB 701 A

AGB701 PAST

AGB1402 PAST

AGB701 BT PAST

AGB1402 BT PAST

Precio Price Prix					
Medidas Measures [mm] Mesures	687 x 794 x 2130 mm.	687 x 794 x 2130 mm.	1385 x 794 x 2130 mm.	687 x 794 x 2130 mm.	1385 x 794 x 2130 mm.
Temperatura Temperature Température	-2°C/+8°C		-2°C/+8°C		-18°C
Clase Climática Climatic class Classe climatique	5 / 40°C		5 / 40°C		4 / 38°C
Tensión/Frecuencia Electrical data Tension électrique	230V/1ph/50Hz				
Controlador Controller Régulateur	Digital IP65				
Material Material [EXT/INT] Matériel	AISI 304				
Espesor Thickness Épaisseur	75				
Aislamiento Isolation Isolation	40kg/m ³ / Free CFC's / Zero ODP-GWP				
Capacidad Capacity Capacité	560	560	1240	560	1240
Puertas Doors Portes	1	1	2	1	2
Nº parrillas / Guías Nº shelves / Slides Nº de grilles / Glissière	3 [530x650]	0/18	0/36	0/18	0/36
Sistema de frío Cooling System Système de froid	MONOBLOCK		Forzado / Forced air / Ventilé		
Desescarche Defrost Dégivrage	Parada compres./ Compressor off/ Arrêt compres.	Parada de compresor / Compressor off / Arrêt du compresseur		Gas caliente / Hot gas / Gaz chaud	
Expansión Expansion Expansion	Válv. de expans. Electrónica / Electronic expansion valve / Valve d'expans. Electronique	Capilar / Capillary / Capillaire		Válv. Expansión/ Expansion valve/ Détendeur thermostatique	
Potencia Power Puissance	110	210	420	683	1054
Potencia frig. Cooling capacity Puissance Frig.	334	370	690	644	1010
Consumo Consumption Consommation	0,94	1,54	2,55	7,80	13,92
Clase energética Energy class Classe Énerg.	A	C	B	D	D
Refrigerante Refrigerant Gaz	R-600a	R-290			
Opcional Optional Options	Manejo control digital bluetooth o wifi / Operating digital control bluetooth or wifi / Trait. de contrôle digital bluetooth ou wifi Ruedas / Casters / Roulettes [705X16=2; 705X17=2] Parrilla / Wire shelf / Grille [502X26] Juego de guías / Set of Slides / Jeu de Glissières [GUIAL0120641; GUIAL0220641] Bandeja / Tray / Plateau 600x400 [A850P41] Cerradura / Lock / Serrure [506X209; 506X210] 115V/1ph/60Hz 230V/1ph/60Hz				

Serie / Series / Série **AGB A 700 INVERTER**
 Serie / Series / Série **AGB 700/1400L**

+Info: www.infrico.com

ECO

EFFICIENT
 Clase energética
 Energy class
 Classe Énerg. **A**
INVERTER

AGB 701 A



Compresor de velocidad variable
 Variable-capacity compressor
 Compresseur vitesse variable



Costados embutidos
 Stamped inner sides
 Intérieurs emboutis



Parrillas reforzadas
 Reinforced wire shelves
 Grilles renforcées

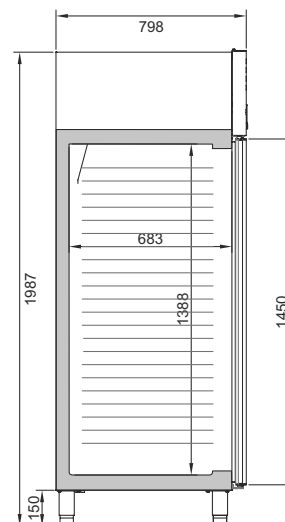

36 bandejas 600x400 (no incluidas)
 36 trays 600x400 (not included)
 36 plateaux 600x400 (non inclus)

AGB 1402 BT PAST



 internet of things	Opcional: Manejo control digital por WiFi o  Bluetooth®
	Optional: Operating digital control by WiFi or  Bluetooth®

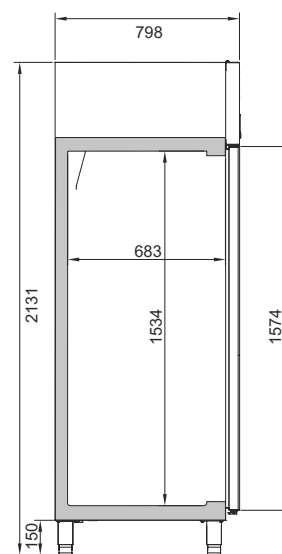

Armarios Euronorm 800x400 pastelería-heladería / Armario Cátering

Euronorm 800x400 pastry-ice cream reach in / Catering reach in

Armoire Euronorme 800x400 pâtisserie-glace / Armoire traiteur catering

HELADERÍA-PASTELERÍA / ICE CREAM-PASTRY / GLACE-PÂTISSERIE

Cátering / Catering / Catering



AGB901



AGB901BT



AC600 R



AC600 BT

MODELO MODELE MODÈLE	AGB901	AGB901BT	AC600 R	AC600 BT
Precio Price Prix				
Medidas Measures [mm] Mesures	796 x 960 x 2130 mm.	796 x 960 x 2130 mm.	750 x 752 x 1887 mm.	750 x 752 x 1887 mm.
Temperatura Temperature Température	-2°C/+8°C	-22°C/-25°C	0°C/+8°C	-18°C/-25°C
Clase Climática Climatic class Classe climatique	5 / 40°C	4 / 38°C		
Tensión/Frecuencia Electrical data Tension électrique	230V/1ph/50Hz			
Controlador Controller Régulateur	Digital IP65			
Material Material [EXT/INT] Matériel	AISI 304		AISI 430	
Espesor Thickness Épaisseur	75		60	
Aislamiento Isolation Isolation	40kg/m ³ / Free CFC's / Zero ODP-GWP			
Capacidad Capacity Capacité	785		542	
Puertas Doors Portes	1			
Nº parrillas / Guías Nº shelves / Slides Nº de grilles / Glissière	6/6 (600X800)		3 (600X500)	12+1 contenedores / containers / containers
Sistema de frío Cooling System Système de froid	MONOBLOCK Forzado / Forced air / Ventilé		Forzado / Forced air / Ventilé	Estático / Static / Statique
Desescarche Defrost Dégivrage	Parada compresor / Compresor off / Arrêt compresseur.	Gas caliente / Hot gas / Gaz chaud	Parada compresor / Compresor off / Arrêt compresseur.	
Expansión Expansion Expansion	Capilar/ Capillary / Capillaire	Válv. expans. Termostática / Thermostatic expans. valve/ Valv. d'expans. Thermostatique	Capilar/ Capillary / Capillaire	
Potencia Power Puissance	370	680	240	230
Potencia frig. Cooling capacity Puissance Frig.	690	742	370	304
Consumo Consumption Consommation	1,60	7,95	-	
Clase energética Energy class Classe Énerg.	B	D	-	
Refrigerante Refrigerant Gaz	R-290			
Opcional Optional Options	115V/1ph/60Hz		230V/1ph/60Hz	
	Manejo control digital bluetooth o wifi / Operating digital control bluetooth or wifi / Trait. de contrôle digital bluetooth ou wifi Parrilla / Wire shelf / Grille [502X94] Bandeja / Tray / Plateau 600x400 [A850P41] Cubeta helados 5 L. / 5 L. ice cream tray / Bacs à glace 5 L. [501X32] Cerradura / Lock / Serrure [506X209]		Parrilla / Wire shelf / Grille [502X76] Ruedas / Casters / Roulettes [705X16; 705X17 =2] Contenedor / Container / Container 500x300x180mm [501X44] Contenedor / Container 600x400x220mm [501X45]	

Serie / Series / Série **AGB 900L**
 Serie / Series / Série **AC 600L**

+Info: www.infrico.com

AGB 901 BT 



Capacidad 54 cubetas de helado de 5 L. [no incluidas]
 Capacity 54 ice-cream 5 L. Trays [not included]
 Capacité 54 bacs à glace 5 L. [non inclus]

AC 600 BT

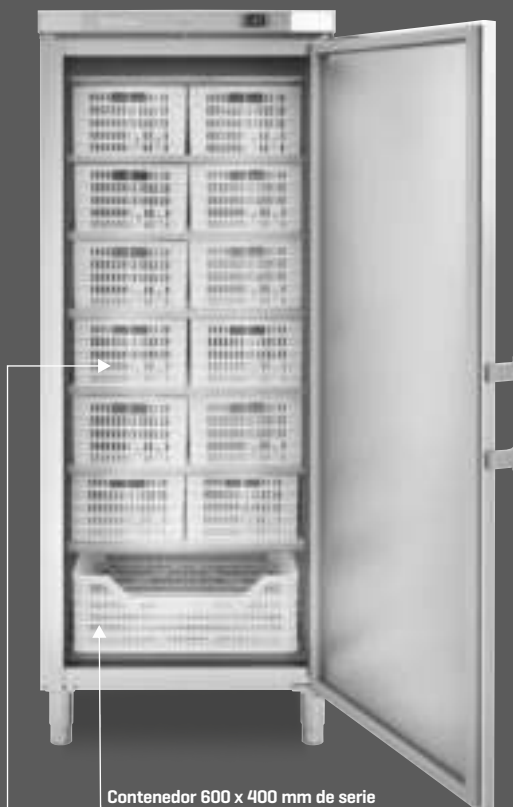

Contenedor 600 x 400 mm de serie
 Container 600 x 400 mm standard
 Container 600 x 400 mm de série

Contenedor 500 x 300 mm de serie
 Container 500 x 300 mm standard
 Container 500 x 300 mm de série



AGB 901

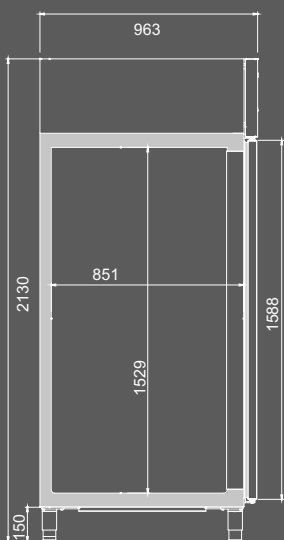

AC 600 BT

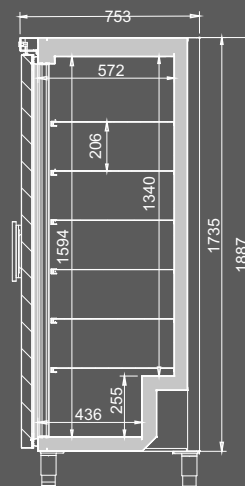

Armario Fermentación

Retarder proofer cabinet

Armoire de fermentation



FC900BT



FC900BT CR

MODELO MODELE MODÈLE	FC900BT	FC900BT CR
Precio Price Prix		
Medidas Measures [mm] Mesures	796 x 960 x 2130 mm.	796 x 960 x 2130 mm.
Temperatura Temperature Température	-18°C/+35°C	
Clase Climática Climatic class Classe climatique	4 / 38°C	
Tensión/Frecuencia Electrical data Tension électrique	230V/1ph/50Hz	
Controlador Controller Régulateur	Digital IP65	
Material Material [EXT/INT] Matériel	AISI 304	
Espesor Thickness Épaisseur	75	
Aislamiento Isolation Isolation	40kg/m ³ / Free CFC's / Zero ODP-GWP	
Capacidad Capacity Capacité	785	
Puertas Doors Portes	1	
Nº parrillas / Guías Nº shelves / Slides Nº de grilles / Glissière	0/20	
Sistema de frío Cooling System Système de froid	Forzado / Forced air / Ventilé	
Desescarche Defrost Dégivrage	Gas caliente / Hot gas / Gaz chaud	
Expansión Expansion Expansion	Válv. expans. Termostática / Thermostatic expans. valve/ Valv. d'expans. Thermostatique	
Potencia Power Puissance	1762	
Potencia frig. Cooling capacity Puissance Frig.	Frío / Cool / Froid 1600 Calor / Heat / Chauffé 750	
Consumo Consumption Consommation	-	
Clase energética Energy class Classe Énerg.	-	
Refrigerante Refrigerant Gaz	R-290	
Opcional Optional Options	115V/1ph/60Hz + 6% 230V/1ph/60Hz Manejo control digital bluetooth o wifi / Operating digital control bluetooth or wifi / Trait. de contrôle digital bluetooth ou wifi Parrilla / Grate / Grille 800X600 [502X94] Parrilla/ Grate / Grille 600X400 [502X26] Juego guías/Slides/Jeu Glissières [GUAL0120806; GUAL0220806] Cerradura/Lock/Serrure [506X209] KIT Filtro agua / Water filter / Filtre à eau [4600x0018] Bandeja 600x400/ Tray 600x400 / Plateau 600x400	

NEW

Series / Série **FC 900 BT**

+Info: www.infrico.com

FC 900 BT CR



Humidificador
Humidifier
Humidificateur

Puerto USB
USB Connection
USB

Diseño interior con cremallera y guías
Interior design with zip and guides
Design intérieur avec serrure et glissières

Resistencia aleteada en acero inox
Stainless steel finned heater
Resistance à ailettes en Inox

FC 900 BT



Opción Kit filtro de agua
Option Kit water filter
Optionel Kit filtre à eau



Video del producto

Product Video
Vidéo du produit



Infrico Youtube

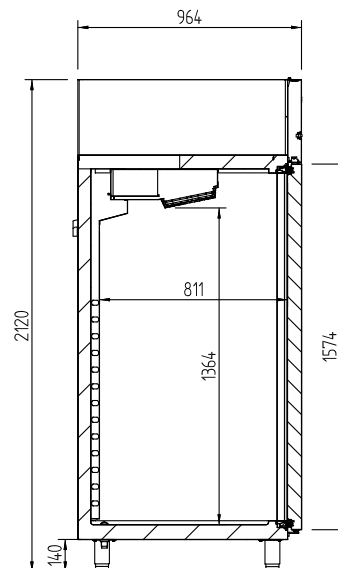

Cambiar tiempo de fin de ciclo
Change end of cycle time
Modifier la durée de fin de cycle







Cambiar valor de temperatura
Change temperature setpoint
Modifier la température de consigne



Cambiar valor de humedad
Change humidity setpoint
Modifier la valeur de l'humidité



Armarios para carros GN2/1, 600x400, 650x450, 1300/2700L /
GN2/1, 600x400, 650x450, 1300/2700L roll-in /
 Armoire à chariot GN2/1, 600x400, 650x450, 1300/2700L

MODELO MODELE MODÈLE				
	RIC1P	RIC1P BT	RIC2P	RIC1P TH Pasante/Pass-thru/Traversante
Precio Price Prix				
Medidas Measures [mm] Mesures	876 x 1090 x 2414 mm.	876 x 1090 x 2414 mm.	2000 x 1090 x 2414 mm.	940 x 1180 x 2414 mm.
Temperatura Temperature Température	0°C/+8°C	-18°C	0°C/+8°C	
Clase Climática Climatic class Classe climatique	5 / 40°C	4 / 30°C	5 / 40°C	
Tensión/Frecuencia Electrical data Tension électrique	230V/1ph/50Hz			
Controlador Controller Régulateur	Digital IP65			
Material Material [EXT/INT] Matériel	AISI 304			
Espesor Thickness Épaisseur	80			
Aislamiento Isolation Isolation	40kg/m ³ / Free CFC's / Zero ODP-GWP			
Capacidad Capacity Capacité	1224	1224	2937	1245
Puertas Doors Portes	1	1	2	1
Nº parrillas / Guías Nº shelves / Slides Nº de grilles / Glissière	-			
Sistema de frío Cooling System Système de froid	MONOBLOCK Ventilado / Forced Air / Ventilé			
Desescarche Defrost Dégivrage	Parada compresor / Compresor off / Arrêt compresseur.	Gas caliente/ Hot Gas / Gaz Chaude	Parada compresor / Compresor off / Arrêt compresseur.	
Expansión Expansion Expansion	Capilar/ Capillary / Capillaire	Válv. expans. Termostática / Thermostatic expans. valve/ Valv. d'expans. Thermostatique	Capilar/ Capillary / Capillaire	
Potencia Power Puissance	380	870	760	380
Potencia fríg. Cooling capacity Puissance Frig.	687	1011	1374	687
Consumo Consumption Consommation	3,90	15,6	7,4	4,86
Clase energética Energy class Classe Énerg.	-			
Refrigerante Refrigerant Gaz	R-290			
Tamaño máximo Carro Size maximum Rack Dimensions max. Chariot	700 x 1880 x 880 mm			
Opcional Optional Options	<p>Manejo control digital bluetooth o wifi / Operating digital control bluetooth or wifi / Trait. de contrôle digital bluetooth ou wifi</p> <p>Carro / Rack / Chariot (455x635x1787) GN 1/1 [CBGN2011]</p> <p>Carro / Rack / Chariot (660x755x1787) GN2/1 [CBGN2021]</p> <p>Carro / Rack / Chariot (530x705x1787) 600x400 mm [CBE20]</p>			

NEW

Series / Série **RIC**

+Info: www.infrico.com



RIC1PTH
Pasante / Pass-thru / Traversante

 <p>Internet of things</p>	<p>Optional: Manejo control digital por WiFi o  Bluetooth*</p>	<p>Optional: Operating digital control by WiFi or  Bluetooth*</p>
	<p>*Optional: Manejo control digital por WiFi o  Bluetooth*</p>	



RIC2P



RIC 1P BT



CBGN 2011
CBGN 2021

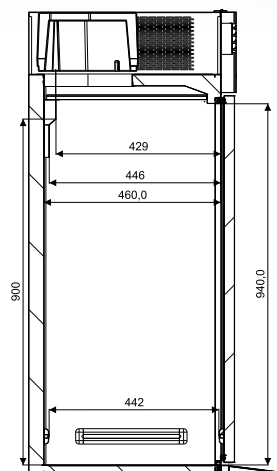

RIC 1P/2P

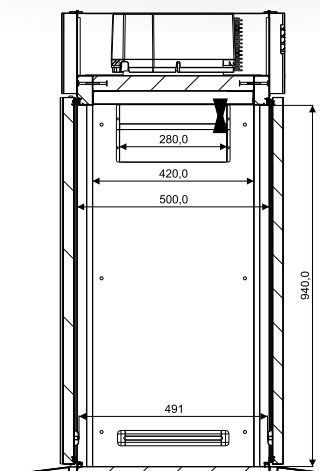

RIC1PTH
Pasante/Pass-thru/Traversante

4. Abatidores

Blast Chillers / Cellules de Refroidissement





4. Abatidores

Blast Chillers / Cellules de Refroidissement





4. Abatidores

Blast Chillers / Cellules de Refroidissement

Controlador táctil
integrado en la puerta.
Diseño innovador.
USB integrado en el
lateral.

Contrôleur tactile intégré
dans la porte. Conception
innovative.
USB intégré sur le côté.

Touch controller
integrated in the door.
Innovative design.
USB integrated in the side.



Refrigeración / Refrigeration / Réfrigération



ABT5L



ABT71M



ABT101L

Compatibles con diferentes tipos de carro.

Compatible with different types of trolleys.

Compatible avec différents types de chariots.



+Info: www.infrico.com

Nuevo tirador en los modelos ABT20.

New handle on ABT20 models.

Nouvelle poignée sur les modèles ABT20.



ABT20 1CBI



ABT20 2P

Rampa opcional en los modelos ABT20 (excepto S).

Optional ramp on ABT20 models (except S).

Rampe en option sur les modèles ABT20 (sauf S).



4. Abatidores

Blast Chillers / Cellules de Refroidissement

Serie / Series / Série

Función del abatidor y ciclos de trabajo

142 - 143

How blast chillers work & cycle functions

Fonction de la cellule de refroidissement et cycles de travail

Serie / Series / Série

ABT

Abatidores y congeladores de temperaturas 3, 5, 6, 7, 10 y 14 niveles

144 - 145

Blast chillers and freezers 3, 5, 6, 7, 10 and 14 levels

Cellules de refroidissement et surgélation 3, 5, 6, 7, 10 et 14 niveaux

Serie / Series / Série

ABT

Abatidores y congeladores de temperaturas 20 niveles

146 - 147

Blast chillers and freezers 20 levels

Cellules de refroidissement et surgélation 20 niveaux

Serie / Series / Série

ABT

Abatidores y congeladores de temperaturas 20 niveles dobles

148 - 149

Blast chillers and freezers 20 levels

Cellules de refroidissement et surgélation 20 niveaux doubles

+Info: www.infrico.com

RESTYLING
Serie / Series / Série
3 - 5
6 - 7
10 - 14



ABT3 1S **ABT5 1L** **ABT5 1C** | **ABT6 1C** **ABT7 1L** **ABT7 1M** | **ABT10 1L** **ABT14 1L** **ABT10 2S**
3 - 5 Niveles / Levels / Niveaux | 6 - 7 Niveles / Levels / Niveaux | 10 - 14 Niveles / Levels / Niveaux

RESTYLING
Serie / Series / Série
20



ABT20 1CBI **ABT20 1C** **ABT20 2C** **ABT20 1S** **ABT20 2S** **ABT20 1P** **ABT20 2P** **ABT20 2CP** **ABT20 2SP** **ABT20 2PP**
20 Niveles / Levels / Niveaux

RESTYLING
Serie / Series / Série
20
Dobles /
Doubles /
Doubles



ABT20 3C **ABT20 4C** **ABT20 3P** **ABT20 4P** **ABT20 3CP** **ABT20 4CP** **ABT20 3PP** **ABT20 4PP**
20 Niveles Dobles / 20 Double levels / 20 Niveaux Doubles



Función del abatidor y ciclos de trabajo

How blast chillers work & cycle functions

Fonction de la cellule de refroidissement et cycles de travail

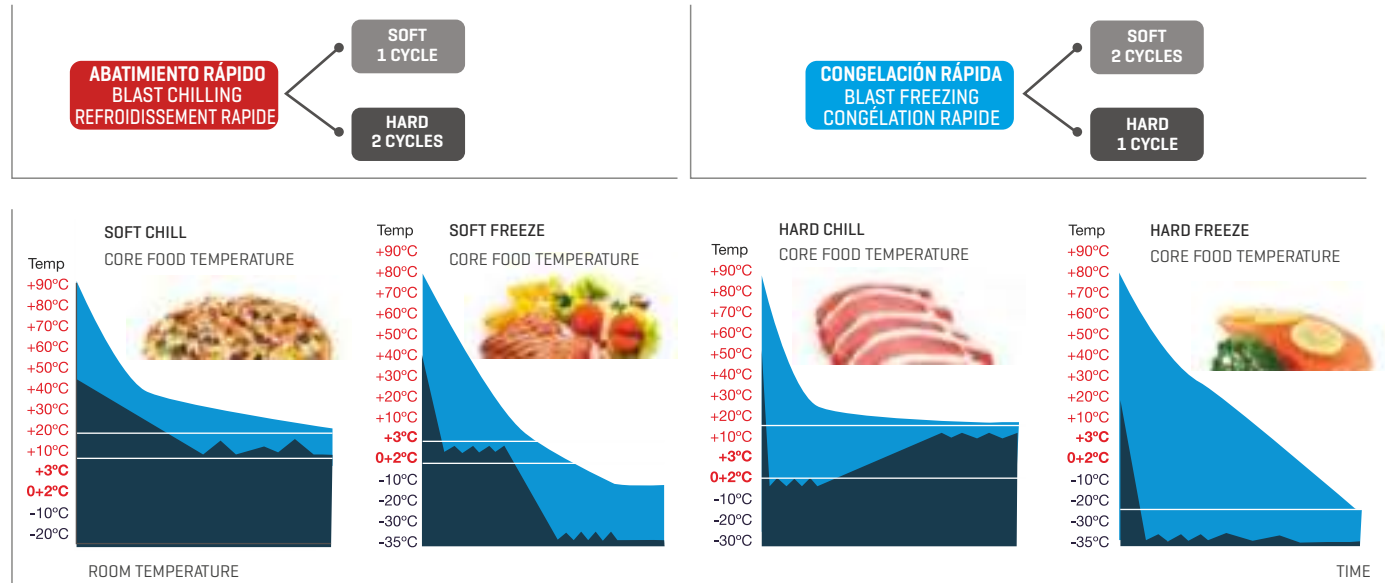

Función de abatidor

Los abatidores permiten reducir en un tiempo muy breve la temperatura en el corazón de los alimentos, sean cocinados o frescos, conservando sus características de frescura, higiene y calidad, disminuyendo los riesgos de proliferación bacteriana.

- La manera tradicional de conservar los alimentos cocinados ha sido dejar enfriar los alimentos al aire libre hasta que la temperatura del alimento alcance una temperatura ideal para su conservación en el refrigerador.

- La fase de enfriamiento entre +65°C y +10°C es un intervalo de tiempo que compromete las características naturales del producto [humedad, consistencia, aroma, color] y lo somete a la agresión y a la consecuente proliferación bacteriana.

- Con los ABATIDORES INFRICO se persigue reducir al máximo la permanencia de los alimentos en este intervalo crítico de temperaturas.

How blast chillers work

Blast chillers quickly reduce the core temperature of the products, whether they are cooked or fresh, conserving their fresh texture, hygiene and quality, whilst reducing the risk of bacteria generation.

- The traditional method of storing cooked food has always been to leave it to cool naturally until it reaches a suitable temperature to store in the refrigerator.

- During the period when the core temperature falls from +65°C and +10°C, the food will lose a lot of its natural characteristics, such as moisture, consistency, aroma and colour. Furthermore, this is when bacteria begin to grow.

- INFRICO BLAST CHILLERS are designed to reduce the time period for this critical change in temperature.

Fonction cellule de ref.

Les cellules de refroidissement permettent de réduire très rapidement la température au cœur des aliments, qu'ils soient cuits ou frais, tout en conservant leurs caractéristiques de fraîcheur, d'hygiène et de qualité, et en réduisant le risque de prolifération bactérienne.

- La manière traditionnelle de conserver les aliments cuisinés est de les laisser refroidir à l'air libre jusqu'à ce que leur température atteigne une valeur idéale pour leur conservation au réfrigérateur.

- La phase de refroidissement de +65°C à +10°C est un espace de temps qui compromet les caractéristiques naturelles du produit [humidité, consistance, arôme et couleur] et l'expose à l'agression ainsi qu'à la prolifération bactérienne qui peut en suivre.

- Les CELLULES DE REFROIDISSEMENT INFRICO, sont conçues pour réduire au maximum la permanence des aliments dans cet intervalle critique de températures.



+Info: www.infrico.com

CARACT. PRINCIPALES



Diseño elegante, ausencia de espesor y facilidad de uso.



Opción ciclos personalizados con 3 fases de regulación.



Grado de protección de la interfaz del usuario IP65.



Gestión de ciclos de abatimiento y sobrecongelación, por temperatura y por tiempo, con función "hard/soft" y gestión de la intensidad.



Gestión del test para comprobar que la sonda pincho se ha colocado correctamente (incluidas las sondas de tipo "multipoint").



Representación gráfica en tiempo real del ciclo de abatimiento/sobrecongelación en curso.

MAIN FEATURES

Stylish design, flush mounted, user-friendly.

Option personalized cycles with 3 regulation phases.

User interface with IP65 protection.

Management of blast chilling and freezing cycles, both temperature and time controlled, with hard/soft and intensity management functions.

Runs a test to check that the needle probe is correctly inserted (including multipoint probes).

Real-time graphic display for blast chilling/freezing cycle in progress.

CARACT. PRINCIPALES

Lignes élégantes et faciles d'utilisation.

Option cycles personnalisés avec 3 phases de régulation.

Haute protection de l'interface de l'utilisateur IP65.

Gestion des cycles de refroidissement et de surgélation, par température et durée, avec la fonction « hard/soft » et gestion de l'intensité.

Test pour vérifier si la sonde est correctement mise (inclues les sondes de type « multipoint »).

Représentation graphique en temps réel du cycle de refroidissement et surgélation en cours.

VENTAJAS



Sonda calefactada.



Gestión de ciclos especiales (higienización pescado, descongelación, endurecimiento helado, etc...)



Possibilidad de personalizar 99 programas.

ADVANTAGES

Heated probe.

Management of special cycles (fish sanitation, thawing, ice cream hardening, etc.)

Possibility to personalize 99 programs

AVANTAGES

Sonde chauffée.

Gestion des cycles spéciaux (hygiénisation du poisson, décongélation, durcissement de la glace, etc...)

Possibilité de personnaliser 99 programmes.

Nuevos ciclos especiales como:
Higienización pescado,
descongelación,
endurecimiento helado, etc...

New special cycles:
Fish sanitation, ice cream
hardening, etc...

Nouveaux cycles spéciaux
comme:
hygiénisation du poisson,
décongélation,
durcissement de la glace, etc...

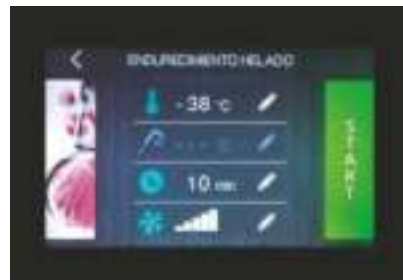
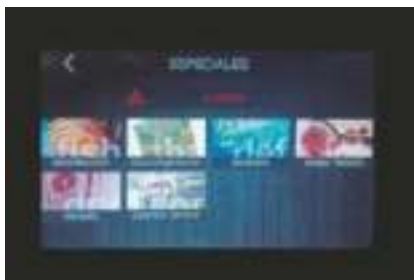

Abatidores y congeladores de temperatura / Blast chillers and freezers / Cellule de refroidissement et surgélation

3 - 5 Niveles / Levels / Niveaux

6 - 7 Niveles / Levels / Niveaux

10 - 14 Niveles / Levels / Niveaux

MODELO
MODELE
MODÈLE



ABT3 1S

ABT5 1L

ABT5 1C

ABT6 1C

ABT7 1L

ABT7 1M

ABT10 1L

ABT14 1L

ABT10 2S

Precio Price Prix									
Medidas Measures [mm] Mesures	721 x 711 x 536 mm.	837 x 870 x 950 mm.	837 x 724 x 800 mm.	508 x 863 x 1059 mm.	837 x 870 x 1120 mm.	1468 x 700 x 940 mm.	837 x 870 x 1730 mm.	837 x 870 x 1730 mm.	1072 x 1076 x 1950 mm.
Temperatura Temperature Température	+3°C / -38°C								
Clase Climática Climatic class Classe climatique	4 / 38°C								
Tensión/Frecuencia Electrical data Tension électrique	220V/1ph/50Hz						380V/3ph/50Hz		
Controlador Controller Régulateur	Táctil / Touch-screen / Tactile IP65								
Material Material [EXT/INT] Matériel	AISI 304								
Espesor Thickness Épaisseur	35	65				65	65	65	
Aislamiento Isolation Isolation	40kg/m ³ / Free CFC's / Zero ODP-GWP								
Capacidad Capacity Capacité	68	125	95	85	160	120	315	315	640
Compresor Compressor Compresseur	1/2	1		1	1 1/4		2	2 1/2	4
Capacidad refrig./cong. Freezing capacity [Kg.] Rendement refroid./cong.	10/5*	20/12*		20/12*	30/18*		40/25*	50/30*	80/50*
Distancia entre bandejas Distance between trays Distance entre bacs	65								80
Nº Bandejas (Opcional) Trays (Optional) Nº Bacs (Option)	3 GN 1/1	5 GN 1/1 600x400	5 GN 1/1	6 GN 1/1	7 GN 1/1 600x400	7 GN 1/1	10 GN 1/1 600x400	14 GN 1/1 600x400	10 GN 2/1 800x600
Sistema de frío Cooling System Système de froid	Forzado / Forced-air / Forcé								
Desescarche Defrost Dégivrage	Parada compresor / Compressor off / Arrêt du compresseur								
Expansión Expansion Expansion	Válvula de expansión termostática / Thermostatic expansion valve / Détendeur thermostatique								
Potencia Power Puissance	761	1205	1412	1125	2409	2393	2250	2824	3517
Potencia frig. Cooling capacity Puissance Frig.	1296	1805			2609		3723	5445	9766
Opcional Optional Options	Esterilizador/Sterilizer/Stérilisateur (407x26) Registador/Recorder/Enregistreur (308x59) Bandejas inox GN 1/1 / Stainless Steel GN1/1 / Bacs Inox GN 1/1 (501x23)					Bandeja 600x400 / 600x400 trays / Bac 600x400 (A850P41) Manejo control digital bluetooth o wifi / Operating digital control bluetooth or wifi / Trait. de contrôle digital bluetooth ou wifi			
	115V/1ph/60Hz 230V/1ph/60Hz					220V/1ph/50Hz 220V/1ph/60Hz 380V/3ph/60Hz 440V/1ph/60Hz			
	Entrada bandeja / 1S Trays entry / 1C Entrée bac					1L GN 1/1 600x400			

*Rendimientos probados según la norma EN17032

*Capacity tested according to EN17032 standard

*Rendement prouvé selon la norme EN17032

RESTYLING

Serie / Série 3 - 5 - 6 - 7 - 10 - 14

+Info: www.infrico.com

ABT7 1M



ABT6 1C



ABT5 1L

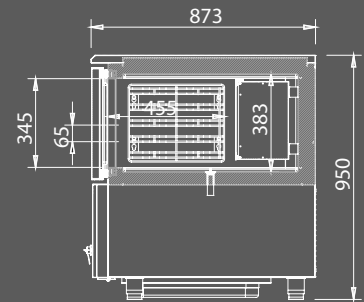

ABT10 1L



ABT10 1L

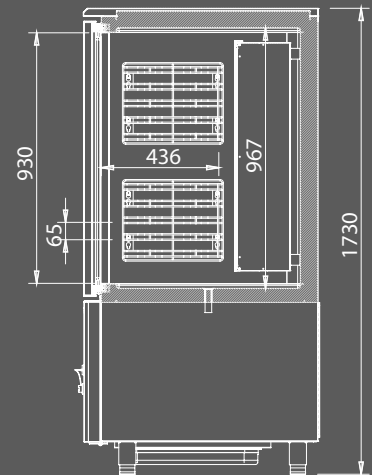

Abatidores y congeladores de temperatura / Blast chillers and freezers / Cellule de refroidissement et surgélation



MODELO
MODELE
MODÈLE

ABT20 1CBI ABT20 1C ABT20 2C ABT20 1S ABT20 2S ABT20 1P ABT20 2P ABT20 2CP ABT20 2SP ABT20 2PP

Precio Price Prix										
Medidas Measures [mm] Mesures	1200 x 1125 x 2465 mm.	1200 x 1125 x 2280 mm.	1400 x 1325 x 2280 mm.	1200 x 1125 x 2280 mm.	1400 x 1325 x 2280 mm.	1200 x 1120 x 2280 mm.	1400 x 1420 x 2280 mm.	1400 x 1325 x 2280 mm.	1400 x 1325 x 2280 mm.	1400 x 1420 x 2280 mm.
Temperatura Temperature Température	+3°C / -40°C									
Clase Climática Climatic class Classe climatique	4 / 38°C									
Tensión/Frecuencia Electrical data Tension électrique	380V/3ph/50Hz									
Controlador Controller Régulateur	Táctil / Touch-screen / Tactile IP65									
Material Material [EXT/INT] Matériel	AISI 304									
Espesor Thickness Épaisseur	80									
Aislamiento Isolation Isolation	40kg/m ³ / Free CFC's / Zero ODP-GWP									
Capacidad Capacity Capacité	1704	1861	2747	1686	2489	1861	2747	2747	2489	2747
Capacidad refrig./cong. Freezing capacity [Kg.] Rendement refroid./cong.	110 / 60*							230 / 130*		
Tamaño máximo Carro Size maximum Rack Dimensions max. Chariot	700 x 1835 870 mm	700 x 1900 870 mm	830 x 1900 1070 mm	700 x 1700 870 mm	830 x 1700 1070 mm	700 x 1900 870 mm	830 x 1900 1070 mm	830 x 1900 1070 mm	830 x 1700 1070 mm	700 x 1900 1070 mm
Sistema de frío Cooling System Système de froid	Forzado / Forced-air / Forcé									
Desescarche Defrost Dégivrage	Parada compresor / Compressor off / Arrêt du compresseur									
Expansión Expansion Expansion	Válvula de expansión termostática / Thermostatic expansion valve / Détendeur thermostatique									
Potencia Power Puissance	6502	9773	9773	9693		9943		15343	15387	15443
Potencia frig. Cooling capacity Puissance Frig.	10073 [-10°C] / 5387 [-25°C]							20869 [-10°C] / 11411 [-25°C]		
Opcional Optional Options	Rampa / Ramp / Rampe [RAMABT21] Manejo control digital bluetooth o wifi / Operating digital control bluetooth or wifi / Trait. de contrôle digital bluetooth o wifi					Carro / Rack / Chariot [455x635x1787] GN 1/1 [CBGN2011] Carro / Rack / Chariot [660x755x1787] GN2/1 [CBGN2021] Carro / Rack / Chariot [530x705x1787] 600x400 mm [CBE20]				
	-	220V/1ph/50Hz 220V/1ph/60Hz 380V/3ph/60Hz 440V/1ph/60Hz				Opcional Condensadora ventilado axial o ventilado centrifugo o por agua Optional Condensing unit axial ventilated or centrifugal ventilated or water ventilated Options Unité de condensation à ventilation axiale ou centrifuge ou à ventilation par eau				

Motocondensadora incluida
Condensing unit included
Unité de condensation de série

*Rendimientos probados según la norma EN17032
*Capacity tested according to EN17032 standard
*Rendement prouvé selon la norme EN17032

Entrada carro / Car entry / Entrée chariot



C
Ruedas dentro
Wheels inside
Roulettes à l'intérieur



CP/SP/PP
Potenciados
Powerfull
Plleine puissance



S
Ruedas fuera
Wheels outside
Roulettes à l'extérieur



P
Pasante
Pass-throw
Traversante

ABT20 1S



ABT20 1CBI



Pantalla táctil de 7"
Tactil 7" screen
Écran tactile de 7"

Abatimiento rápido: +90°C a +3°C en menos de 90 minutos.
Congelación rápida: +90°C a -18°C en menos de 270 minutos.
 Blast chilling: +90°C to +3°C in less than 90 minutes.
 Blast freezing: +90°C to -18°C in less than 270 minutes.
 Refroidissement rapide: +90°C à +3°C en moins de 90 minutes.
 Congélation rapide: +90°C à -18°C en moins de 270 minutes.

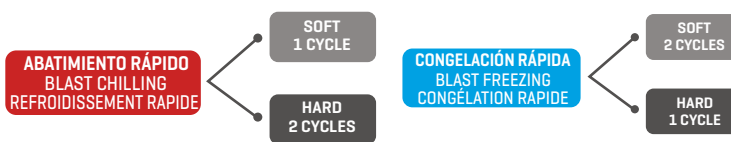

Modelos S compatible con carro Rational
Models S compatible with Rational trolley
Modèles S compatible avec chariot Rational

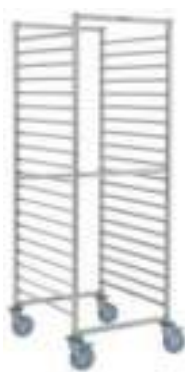

CBGN 2011
CBGN 2021



ABT20 2P

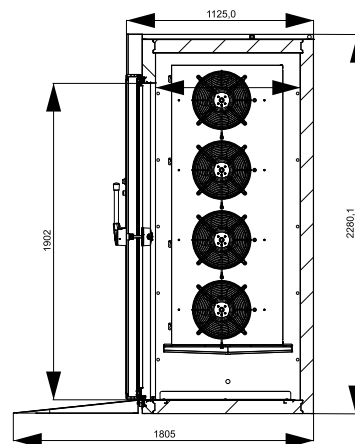

ABT20 1P

Abatidores y congeladores de temperatura / Blast chillers and freezers / Cellule de refroidissement et surgélation



MODELO MODELE MODÈLE	ABT20 3C	ABT20 4C	ABT20 3P	ABT20 4P	ABT20 3CP	ABT20 4CP	ABT20 3PP	ABT20 4PP
Precio Price Prix								
Medidas Measures [mm] Mesures	1200 x 2025 x 2280 mm.	1400 x 2425 x 2280 mm.	1200 x 2120 x 2280 mm.	1400 x 2520 x 2280 mm.	1200 x 2025 x 2280 mm.	1400 x 2425 x 2280 mm.	1200 x 2120 x 2280 mm.	1400 x 2520 x 2280 mm.
Temperatura Temperature Température	+3°C / -38°C							
Clase Climática Climatic class Classe climatique	4 / 38°C							
Tensión/Frecuencia Electrical data Tension électrique	380V/3ph/50Hz							
Controlador Controller Régulateur	Táctil / Touch-screen / Tactile IP65							
Material Material [EXT/INT] Matériel	AISI 304							
Espesor Thickness Épaisseur	80							
Aislamiento Isolation Isolation	40kg/m ³ / Free CFC's / Zero ODP-GWP							
Capacidad Capacity Capacité	3633	5388	3633	5388	3633	5388	3633	5388
Capacidad refrig./cong. Freezing capacity [Kg.] Rendement refroid./cong.	200 / 130*				400 / 260*			
Tamaño máximo Carro Size maximum Rack Dimensions max. Chariot	700 x 1900 1770 mm	830 x 1900 2170 mm	700 x 1900 1770 mm	830 x 1900 2170 mm	700 x 1900 1770 mm	830 x 1900 2170 mm	700 x 1900 1770 mm	830 x 1900 2170 mm
Sistema de frío Cooling System Système de froid	Forzado / Forced-air / Forcé							
Desescarche Defrost Dégivrage	Parada compresor / Compressor off / Arrêt du compresseur							
Expansión Expansion Expansion	Válvula de expansión termostática / Thermostatic expansion valve / Detendeur thermostatique							
Potencia Power Puissance	19546				30886			
Potencia frig. Cooling capacity Puissance Frig.	20146 [-10°C] / 11411 [-25°C]				41738 [-10°C] / 22822 [-25°C]			
Opcional Optional Options	Rampa / Ramp / Rampe [RAMABT21] Manejo control digital bluetooth o wifi / Operating digital control bluetooth or wifi / Trait. de contrôle digital bluetooth ou wifi 220V/1ph/50Hz 220V/1ph/60Hz 380V/3ph/60Hz 440V/1ph/60Hz				Carro / Rack / Chariot [660x755x1787] GN2/1 [CBGN2021] Carro / Rack / Chariot [530x705x1787] 600x400 mm [CBE20] Opcional Condensadora ventilado axial o ventilado centrifugo o por agua Optional Condensing unit axial ventilated or centrifugal ventilated or water ventilated Options Unité de condensation à ventilation axiale ou centrifuge ou à ventilation par eau			

Motocondensadora incluida
Condensing unit included
Unité de condensation de série

***Rendimientos probados según la norma EN17032**

***Capacity tested according to EN17032 standard**

***Rendement prouvé selon la norme EN17032**

Entrada carro / Car entry / Entrée chariot

3C / 4C
Ruedas dentro
 Casters inside
 Roulettes à l'intérieur

3CP / 3PP / 4CP / 4PP

Potenciados
 Powerfull
 Pleine puissance

3P / 4P

Pasante
 Pass-throw
 Traversante

RESTYLING

Series / Série 20 (Doble / Double / Double)

+Info: www.infrico.com



Pantalla táctil de 7"
Tactil 7" screen
Écran tactile de 7"

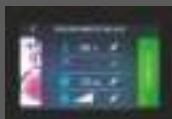

ABT20 4PP



Abatimiento rápido: +90°C a +3°C en menos de 90 minutos.
Congelación rápido: +90°C a -18°C en menos de 270 minutos.

Blast chilling: +90°C to +3°C in less than 90 minutes.

Blast freezing: +90°C to -18°C in less than 270 minutes.

Refroidissement rapide: +90°C à +3°C en moins de 90 minutes.

Congélation rapide: +90°C à -18°C en moins de 270 minutes.

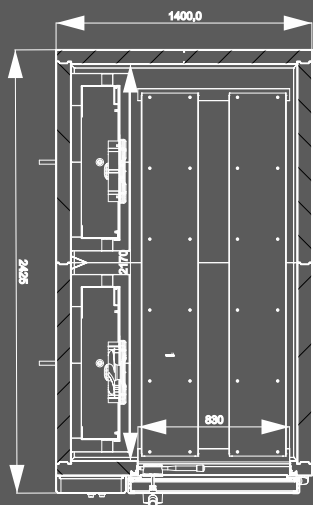

Planta / Floor plan / Plan d'étage

ABT20 4P



CBGN 2021 / CBGN 2011

Motocondensadora incluida
Condensing unit included
Unité de condensation de série



5. Infricool





5. Infricool





5. Infricool

Refrigeración / Refrigeration / Réfrigération

Sistemas de frío ventilado. Bandejas evaporativas sin resistencia eléctrica para una mayor eficiencia energética. Sistemas de evaporación forzada. Evaporadores tratados con Epoxi de poliéster anticorrosión. Unidades sobredimensionadas y eficientes. Válvulas de expansión termostáticas y desescarches por gas caliente en baja temperatura. Marcos de puerta calefactados para evitar acumulación de hielo.

Forced air cooling systems. Energy-saving non-electric condensate pans. Forced evaporation systems. Evaporators treated with anti-corrosion polyester Epoxy. Oversized and efficient units. Expansion valves. Hot gas defrost. Heating door frames to prevent ice build-up.

Systèmes de froid ventilé. Bacs d'évaporation sans résistances électriques pour une meilleure efficacité énergétique. Systèmes d'évaporation forcé. Évaporateurs traités avec un époxy polyester anticorrosion. Unités efficaces et surdimensionnées. Valves d'expansion thermostatiques. Dégivrage par gaz chaud. Cadres de portes chauffés pour empêcher l'accumulation de glace.

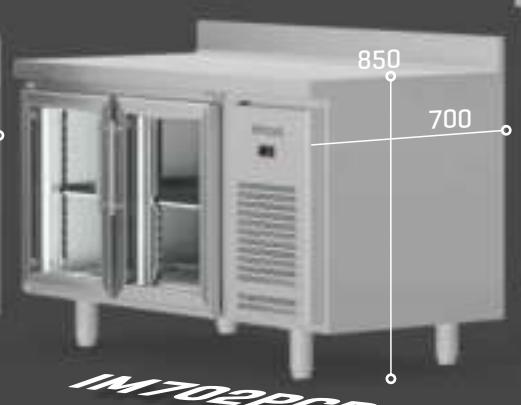
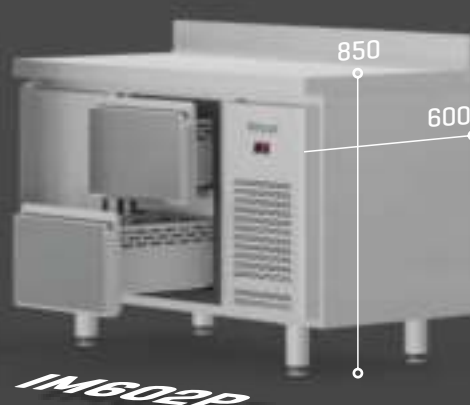
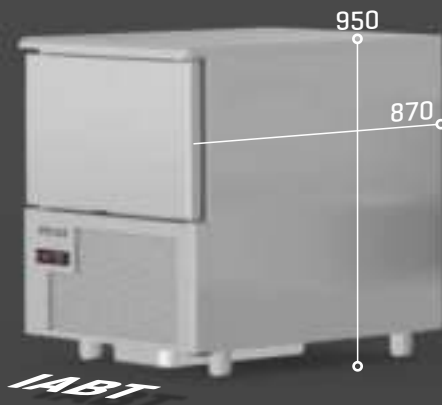

Cajones con guías telescópicas.

Drawers with telescopic guides.

Tiroirs avec glissières télescopiques.



+Info: www.infrico.com

Soporte de cremallera para guías.

Rack and pinion support for guides.

Support de crémaillère pour guides.



Encimera reforzada con Omegas de serie [series 600/700].

Reinforced worktop with Omegas as standard [600/700 series].

Plan de travail renforcé avec Omegas en standard [séries 600/700].



Puertas con tirador embutido y burlete plano desmontable "cleanless".

Inlay doors handle and flat gasket easily removable "cleanless".

Poignée de porte encastrée et joint plat facilement démontable "cleanless".



5. Infricool

Serie / Series / Série		
IABT	Abatidores y congeladores de temperatura 3, 5 y 10 niveles Blast chillers & freezers 3, 5 & 10 levels / Cellules de refroidissement et surgélation 3, 5 et 10 niveaux	158 - 159
Serie / Series / Série		
IEB	Enfriadores de botellas Front bar chest cooler / Refroidisseur de bouteilles	160 - 161
Serie / Series / Série		
IM 600	Mesas refrigeración y congelación Refrigerated counters and freezers / Dessertes positives et négatives	162 - 163
	Mesas refrigeradas puerta de cristal Glass door refrigerated counter / Dessertes positives portes vitrées	162 - 163
Serie / Series / Série		
IM 700	Mesas refrigeración y congelación GN 1/1 GN 1/1 refrigerated counters and freezers / Dessertes positives et négatives GN 1/1	164 - 165
	Mesas refrigeradas con puerta de cristal GN 1/1 GN 1/1 Glass door refrigerated counter / Dessertes positives portes vitrées GN 1/1	164 - 165
Serie / Series / Série		
IF 600	Frente mostrador Tall back bar counter / Desserte arrière bar positive	166 - 167
	Frente mostrador puerta de cristal Glass door tall back bar counter / Desserte arrière bar positive portes vitrées	166 - 167
Serie / Series / Série		
IMC IEST	Mesas cafeteras IMC / estantería IEST Coffee unit IMC & Shelf unit IEST / Cafétéria IMC et Meuble étagère IEST	168 - 169
Serie / Series / Série		
IAN 500/1000	Armarios de refrigeración Reach-in refrigerators / Armoires positives	170 - 171
	Armarios de congelación Reach-in freezers / Armoires négatives	170 - 171
	Armarios de refrigeración puerta de cristal Glass door reach-in refrigerators / Armoires positives portes vitrées	170 - 171
Serie / Series / Série		
IAG 700/1400	Armarios de refrigeración GN 2/1 Reach-in refrigerators GN 2/1 / Armoires positives GN 2/1	172 - 173
	Armarios congelación GN 2/1 Reach-in freezers GN 2/1 / Armoires négatives GN 2/1	172 - 173
	Armarios refrigerados con puerta de cristal GN 2/1 Glass door reach-in refrigerators GN 2/1 / Armoires positives portes vitrées GN 2/1	172 - 173

+Info: www.infrico.com

Serie / Series / Série

IABT



IABT3 1S **IABT5 1L** **IABT10 1L**
3 - 5 - 10 Niveles / Levels / Niveaux

Serie / Series / Série

IEB



IEB 100 **IEB 150** **IEB 200**
REFRIGERACIÓN / REFRIGERATOR / POSITIVE

Serie / Series / Série

IM 600



IM602P **IM603P** **IM604P** **IM602PN** **IM603PN** **IM604PN** **IM602PCR** **IM603PCR** **IM604PCR**
REFRIG / REFRIG / POSIT CONGEL / FREEZ / NÉGAT REFRIG / REFRIG / POSIT

Serie / Series / Série

IM 700



IM702P **IM703P** **IM704P** **IM702PN** **IM703PN** **IM704PN** **IM702PCR** **IM703PCR** **IM704PCR**
REFRIG / REFRIG / POSIT CONGEL / FREEZ / NÉGAT REFRIG / REFRIG / POSIT

Serie / Series / Série

IF 600



IF602P **IF603P** **IF604P** **IF602PCR** **IF603PCR** **IF604PCR**
REFRIGERACIÓN / REFRIGERATOR / POSITIVE

Serie / Series / Série

IMC



IMC100 **IMC150** **IMC200**
MESA CAFETERA / COFFE UNIT / MEUBLE CAFÉTÉRIA

Serie / Series / Série

IEST



IEST100 **IEST150** **IEST200**
MESA ESTANTERÍA / SHELF UNIT / MEUBLE ÉTAGÈRE

Serie / Series / Série

IAN 500/1000



IAN501 **IAN502** **IAN1002** **IAN1004** **IAN501N** **IAN1002N** **IAN501CR** **IAN1002CR**
REFRIG / REFRIG / POSIT CONGEL / FREEZ / NÉGAT REFRIG / REFRIG / POSIT



Serie / Series / Série

IAG 700/1400



IAG701 **IAG1402** **IAG701N** **IAG1402N** **IAG701CR** **IAG1402CR**
REFRIG / REFRIG / POSIT CONGEL / FREEZ / NÉGAT REFRIG / REFRIG / POSIT

Abatidores y congeladores de temperatura 3, 5 y 10 niveles / Blast chillers and freezers 3, 5 & 10 levels / Cellule de refroidissement et surgélation 3, 5 et 10 niveaux

MODELO MODELE MODÈLE	 IABT3 1S	 IABT5 1L	 IABT10 1L
Precio Price Prix			
Medidas Measures [mm] Mesures	721 x 711 x 536 mm.	837 x 870 x 950 mm.	837 x 724 x 800 mm.
Temperatura Temperature Température	+3°C / -38°C		
Clase Climática Climatic class Classe climatique	4 / 38°C		
Tensión/Frecuencia Electrical data Tension électrique	220V/2ph/50Hz		380V/3ph/50Hz
Controlador Controller Régulateur	Tácti / Touch-screen / Tactile IP65		
Material Material [EXT/INT] Matériel	AISI 430		
Espesor Thickness Épaisseur	35	65	60
Aislamiento Isolation Isolation	40kg/m ³ / Free CFC's / Zero ODP-GWP		
Capacidad Capacity Capacité	68	125	485
Compresor Compressor Compresseur	1/2	1	2
Blast chilling Freezing capacity [Kg.] Rendement refroid./cong.	10/5*	20/12*	40/25*
Distancia entre bandejas Distance between trays Distance entre bacs	65		
Nº Bandejas (Opcional) Trays (Optional) Nº Bacs (Option)	3 GN 1/1	5 GN 1/1 600x400	10 GN 1/1 600x400
Sistema de frío Cooling System Système de froid	Forzado / Forced-air / Forcé		
Desescarche Defrost Dégivrage	Parada compresor / Compressor off / Arrêt du compresseur		
Expansión Expansion Expansion	Válvula de expansión termostática / Thermostatic expansion valve / Détendeur thermostatique		
Potencia Power Puissance	761	1205	3498
Potencia frig. Cooling capacity Puissance Frig.	1296	1805	4299
Opcional Optional Options	Esterilizador/Sterilizer/Stérilisateur (407x26) Registador/Recorder/Enregistreur (308x59) Bandejas inox GN 1/1 / Stainless Steel GN1/1 / Bacs Inox GN 1/1 (501x23) Bandeja 600x400 / 600x400 trays / Bac 600x400 (A850P41)		

Entrada bandeja /
Trays entry /
Entrée bac

1S  1C
GN 1/1

1L 
GN 1/1
600x400

*Rendimientos probados según la norma EN17032
*Capacity tested according to EN17032 standard
*Rendement prouvé selon norme EN17032

Serie / Series / Série **IABT**

+Info: www.infrico.com

IABT10 1L



IABT5 1L

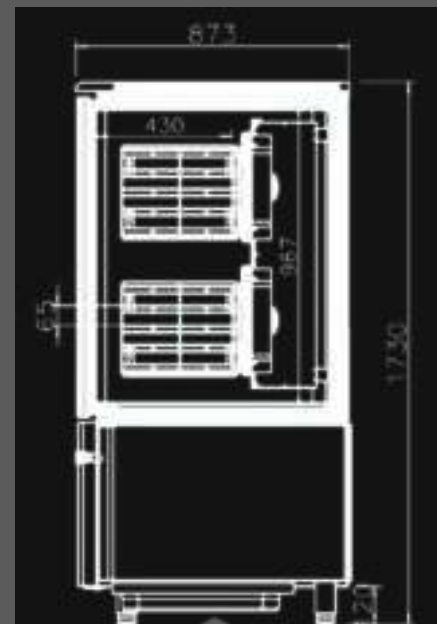
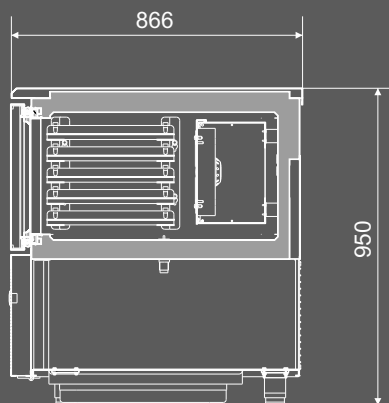

IABT10 1L

Refrigerador de botellas / Chest bottle cooler / Refrigerateur de bouteilles

MODELO
MODELE
MODÈLE



IEB 100



IEB 150



IEB 200

MODELO MODELE MODÈLE	IEB 100	IEB 150	IEB 200
Precio Price Prix			
Medidas Measures [mm] Mesures	1004 x 550 x 865 mm.	1479 x 550 x 865 mm.	1954 x 550 x 865 mm.
Temperatura Temperature Température	+3°C/+6°C		
Clase Climática Climatic class Classe climatique	4 / 38°C		
Tensión/Frecuencia Electrical data Tension électrique	230V/1ph/50Hz		
Controlador Controller Régulateur	-		
Material Material [EXT/INT] Matériel	AISI 430		
Espesor Thickness Épaisseur	40		
Aislamiento Isolation Isolation	40kg/m ³ / Free CFC's / Zero ODP-GWP		
Capacidad Capacity Capacité	265	445	620
Puertas Doors Portes	2	3	4
Nº parrillas / Guías Nº shelves / Slides Nº de grilles / Glissière	-		
Sistema de frío Cooling System Système de froid	Forzado / Forced air / Ventilé		
Desescarche Defrost Dégivrage	-		
Expansión Expansion Expansion	Capilar / Capillary / Capillaire		
Potencia Power Puissance	122	180	
Potencia frig. Cooling capacity Puissance Frig.	169	370	
Consumo Consumption Consommation	-		
Clase energética Energy class Classe Énerg.	-		
Refrigerante Refrigerant Gaz	R-600a	R-290	
Opcional Optional Options	-		

Serie / Series / Série **IEB**

+Info: www.infrico.com

IEB 200

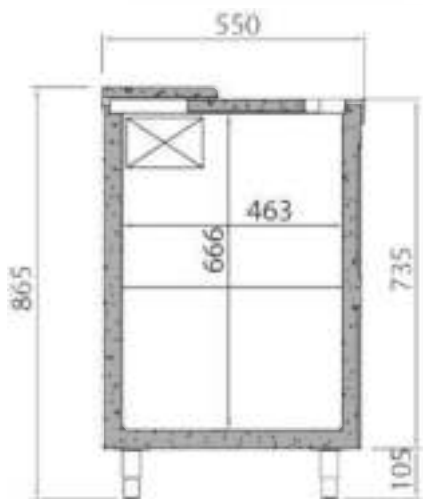



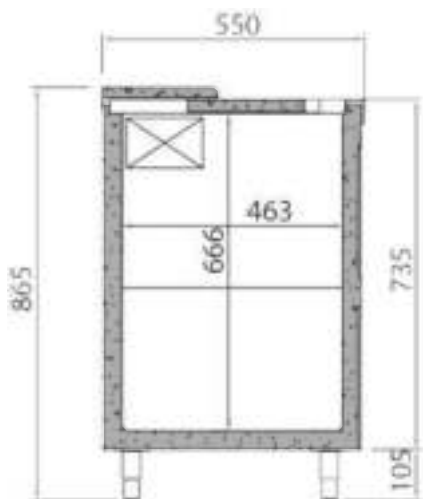





IEB 150



IEB 100

Mesas refrigeración, congelación y puertas de cristal / Refrigerated counters, freezers and glass doors / Dessertes positives et négatives

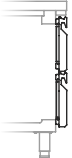
MODELO MODELE MODÈLE									
Precio Price Prix									
Medidas Measures [mm] Mesures	1468 x 600 x 850 mm.	1960 x 600 x 850 mm.	2452 x 600 x 850 mm.	1468 x 600 x 850 mm.	1960 x 600 x 850 mm.	2452 x 600 x 850 mm.	1468 x 600 x 850 mm.	1960 x 600 x 850 mm.	2452 x 600 x 850 mm.
Temperatura Temperature Température [°C]	-2°C/+8°C			-18°C			+2°C/+6°C		
Clase Climática Climatic class Classe climatique [°C]	4 / 38°C								
Tensión/Frecuencia Electrical data Tension électrique	230V/1ph/50Hz								
Controlador Controller Régulateur	Táctil Digital IP65								
Material Material [EXT/INT] Matériel	AISI 430 / Encimera-Worktop-Dessus AISI 304								
Espesor Thickness Épaisseur [mm]	70								
Aislamiento Isolation Isolation [mm]	40kg/m ³ / Free CFC's / Zero ODP-GWP								
Capacidad Capacity Capacité [L]	255	400	540	255	400	540	255	400	540
Puertas Doors Portes	2	3	4	2	3	4	2	3	4
Nº estantes Nº shelves Nº d'étagères	2	3	4	2	3	4	2	3	4
Sistema de frío Cooling System Système de froid	MONOBLOCK Forzado / Forced air / Ventilé								
Desescarche Defrost Dégivrage	Parada compresor / Compressor off / Arrêt du compresseur			Gas caliente / Hot gas / Gaz chaud			Parada compresor / Compressor off / Arrêt du compresseur		
Expansión Expansion Expansion	Capilar / Capillary / Capillaire			Válvula de expansión termostática / Thermostatic expansion valve / Valve d'expansion thermostatique			Capilar / Capillary / Capillaire		
Potencia Power Puissance [W]	255	410	605	694	723	264	269	429	
Potencia frig. Cooling capacity Puissance Frig. [W A -10°C]	370	690	445	540	370	690			
Consumo Consumption Consommation [kWh/ 24h]	2,04	2,37	2,40	4,02	6,57	6,78	-	-	-
Clase energética Energy class Classe Énerg.	B			C			-		
Refrigerante Refrigerant Gaz	R-290								
Opcional Optional Options	Parrilla / Wire shelf / Grille (502X07) 115V/1ph/60Hz 230V/1ph/60Hz								
	Kit 2 cajones / 2 Drawer Kit / Kit 2 tiroirs 1/2 x 200 [JCAJ17FM61/2]								

NEW

Series / Série **IM 600**

+Info: www.infrico.com

IM603P



Controlador digital IP 65.
Digital control IP65
Contrôleur digital IP 65.

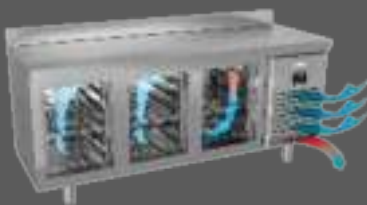

Circulación optimizada del aire
Optimal air flow
Circulation d'air optimisée

Sistema de ventilación de condensación frontal
Front breathing condensation system
Système de ventilation à condensation frontale

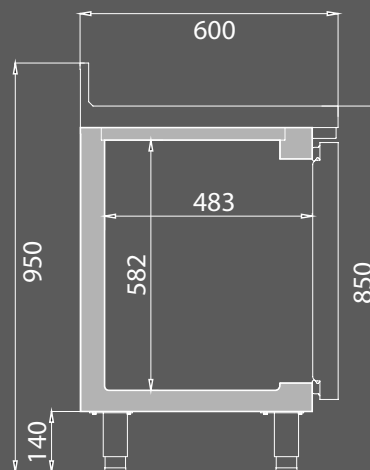

Opcional Kit 2 cajones /
Optional 2 Drawer Kit /
Optional Kit 2 tiroirs
1/2 x 200 (JCAJ17FM61/2)



IM602P









Puertas con doble acristalamiento (6-15-5)
Double glazed doors (6-15-5)
Portes double vitrage (6-15-5)

Suplemento Parrilla incluido
Supplement Wire Shelf including
Supplément Grille inclus



IM602PCR

Mesas refrigeración, congelación y puertas de cristal GN1/1 / GN1/1 Refrigerated counters, freezers and glass doors / Dessertes positives, négatives et portes vitrées GN1/1

MODELO MODELE MODÈLE									
Precio Price Prix									
Medidas Measures [mm] Mesures	1468 x 700 x 850 mm.	1960 x 700 x 850 mm.	2452 x 700 x 850 mm.	1468 x 700 x 850 mm.	1960 x 700 x 850 mm.	2452 x 700 x 850 mm.	1468 x 700 x 850 mm.	1960 x 700 x 850 mm.	2452 x 700 x 850 mm.
Temperatura Temperature Température [°C]	-2°C/+8°C			-18°C			+2°C/+6°C		
Clase Climática Climatic class Classe climatique [°C]	4 / 38°C								
Tensión/Frecuencia Electrical data Tension électrique	230V/1ph/50Hz								
Controlador Controller Régulateur	Digital IP65								
Material Material [EXT/INT] Matériel	AISI 430 / Encimera-Worktop-Dessus AISI 304								
Espesor Thickness Épaisseur [mm]	70								
Aislamiento Isolation Isolation [mm]	40kg/m ³ / Free CFC's / Zero ODP-GWP								
Capacidad Capacity Capacité [L]	305	465	630	305	465	630	305	465	630
Puertas Doors Portes	2	3	4	2	3	4	2	3	4
Nº estantes Nº shelves Nº d'étagères	2	3	4	2	3	4	2	3	4
Sistema de frío Cooling System Système de froid	MONOBLOCK Forzado / Forced air / Ventilé								
Desescarche Defrost Dégivrage	Parada compresor / Compressor off / Arrêt du compresseur			Gas caliente / Hot gas / Gaz chaud			Parada compresor / Compressor off / Arrêt du compresseur		
Expansión Expansion Expansion	Capilar / Capillary / Capillaire			Válvula de expansión termostática / Thermostatic expansion valve / Valve d'expansion thermostatique			Capilar / Capillary / Capillaire		
Potencia Power Puissance [W]	297	460		645	735	880	300	474	479
Potencia frig. Cooling capacity Puissance Frig. [W A -10°C]	370	690		445	540	640	370	690	
Consumo Consumption Consommation [kWh/ 24h]	1,97	2,26	2,61	5,54	7,79	9,03	-		
Clase energética Energy class Classe Énerg.	B			C	D		-		
Refrigerante Refrigerant Gaz	R-290								
Opcional Optional Options	Parrilla / Wire shelf / Grille 530x325 [502X12] Juego de guías / Slides / Jeu de Glissières [GJIAL0115550; GJIAL0215550]						115V/1ph/60Hz 230V/1ph/60Hz		
	Kit 2 cajones / 2 Drawer Kit / Kit 2 tiroirs 1/2 x 200 [JCAJ17FM71/2]						-		

NEW

Series / Série **IM 700**

+Info: www.infrico.com

IM703PN



Ventilación frontal
Front breathing
Ventilation frontale



Controlador digital IP 65.
Digital control IP65
Contrôleur digital IP 65.



Circulación optimizada del aire
Optimal air flow
Circulation d'air optimisée

Sistema de ventilación de condensación frontal
Front breathing condensation system
Système de ventilation à condensation frontale

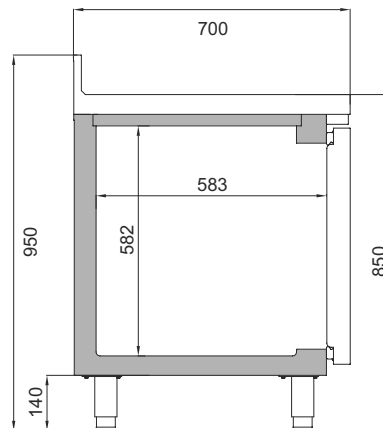

Costado inyectado
Insulated side
Joue Isolée



IM702P







Opcional Kit 2 cajones /
Optional 2 Drawer Kit /
Optional Kit 2 tiroirs

Puertas con doble acristalamiento [6-15-5]
Double glazed doors [6-15-5]
Portes double vitrage [6-15-5]



IM702PCR

Frente mostrador / Tall back bar counter / Dessertes arrière bar positives

MODELO MODELE MODÈLE						
Precio Price Prix						
Medidas Measures [mm] Mesures	1468 x 600 x 1050 mm.	1960 x 600 x 1050 mm.	2452 x 600 x 1050 mm.	1468 x 600 x 1050 mm.	1960 x 600 x 1050 mm.	2452 x 600 x 1050 mm.
Temperatura Temperature Température	-2°C/+8°C			+2°C/+6°C		
Clase Climática Climatic class Classe climatique	4 / 38°C					
Tensión/Frecuencia Electrical data Tension électrique	230V/1ph/50Hz					
Controlador Controller Régulateur	Digital IP65					
Material Material [EXT/INT] Matériel	AISI 430 / Encimera-Worktop-Dessus AISI 304					
Espesor Thickness Épaisseur	70					
Aislamiento Isolation Isolation	40kg/m ³ / Free CFC's / Zero ODP-GWP					
Capacidad Capacity Capacité	345	535	730	345	535	730
Puertas Doors Portes	2	3	4	2	3	4
Nº estantes Nº shelves Nº d'étagères	4	6	8	4	6	8
Sistema de frío Cooling System Système de froid	MONOBLOCK Forzado / Forced air / Ventilé					
Desescarche Defrost Dégivrage	Parada compresor / Compressor off / Arrêt du compresseur					
Expansión Expansion Expansion	Capilar / Capillary / Capillaire					
Potencia Power Puissance	264	435		273	450	455
Potencia frig. Cooling capacity Puissance Frig.	370	690		370	690	690
Consumo Consumption Consommation	2,04	2,40	2,73	-	-	-
Clase energética Energy class Classe Énerg.	B			-		
Refrigerante Refrigerant Gaz	R-290					
Opcional Optional Options	Parrilla / Wire shelf / Grille 325x430 [502X07]					
	Tolva / Coffee-grounds hopper / Tiroir marc à café ou 1 tiroir neutre 115V/1ph/60Hz 230V/1ph/60Hz					

NEW

IF603P



Suplemento Parrilla incluido
Supplement Wire Shelf including
 Supplément Grille inclus

Puertas con doble acristalamiento [6-15-5]
Double glazed doors [6-15-5]
 Portes double vitrage [6-15-5]

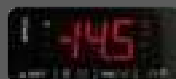

Controlador digital IP 65.
 Digital control IP65.
 Contrôleur digital IP 65.



Tolva opcional
Optional coffee-grounds hopper
 Tiroir marc à café ou 1 tiroir neutre



IF603PCR

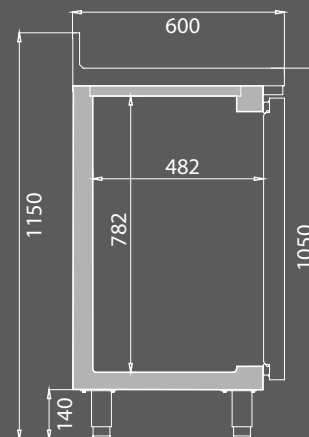

Mesas cafetera / Shelf unit / Meuble étagère (IEST)

MESA CAFETERA / COFFE UNIT / MEUBLE CAFÉTÉRIA

Mesas estantería / Coffee unit / Meuble cafétéria (IMC)

MESA ESTANTERÍA / SHELF UNIT / MEUBLE ÉTAGÈRE

MODELO MODELE MODÈLE						
	IMC100	IMC150	IMC200	IEST100	IEST150	IEST200
Precio Price Prix						
Medidas Measures [mm] Mesures	1000 x 600 x 1050 mm.	1470 x 600 x 1050 mm.	1960 x 600 x 1050 mm.	1000 x 600 x 1050 mm.	1470 x 600 x 1050 mm.	1960 x 600 x 1050 mm.
Material Material Matériel [EXT/INT]	AISI 304					
Puertas Doors Portes	1	1	1	-	-	-
Cajones / Tolva Drawers / Hopper Portes	1/1	1/1	2/1	-	-	-
Estantes Shelves Étagères	1	1	1	1	1	1
Opcional Optional Options	Estante adicional / Additional shelf / Étagère extra (IMC100) Estante adicional / Additional shelf / Étagère extra (IMC150) Estante adicional / Additional shelf / Étagère extra (IMC200)			Estante adicional / Additional shelf / Étagère extra (IEST100) Estante adicional / Additional shelf / Étagère extra (IEST150) Estante adicional / Additional shelf / Étagère extra (IEST200)		



IMC150



IEST150

Serie / Series / Série **IMC / IEST**

+Info: www.infrico.com

IMC200



IMC100

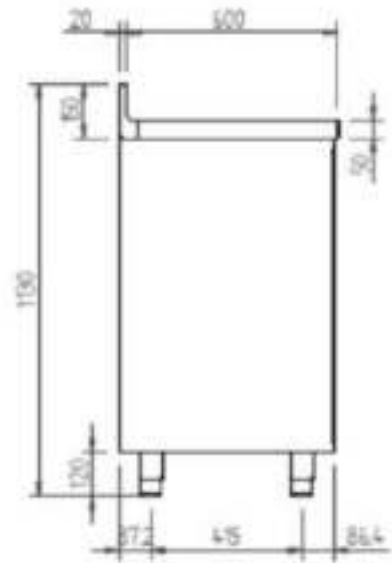

Armario refrigeración, congelación y puertas de cristal / Reach in refrigerators, freezers and glass door / Armoires positives, négatives et portes vitrées

MODELO MODELE MODÈLE	IAN501	IAN502	IAN1002	IAN1004	IAN501N	IAN1002N	IAN501CR	IAN1002CR
Precio Price Prix								
Medidas Measures [mm] Mesures	687 x 712 x 2060 mm.	687 x 712 x 2060 mm.	1385 x 712 x 2060 mm.	1385 x 712 x 2060 mm.	687 x 712 x 2060 mm.	1385 x 712 x 2060 mm.	687 x 712 x 2060 mm.	1387 x 712 x 2060 mm.
Temperatura Temperature Température	-2°C/+8°C				-18°C		+2°C/+6°C	
Clase Climática Climatic class Classe climatique	4 / 38°C							
Tensión/Frecuencia Electrical data Tension électrique	230V/1ph/50Hz							
Controlador Controller Régulateur	Digital IP65							
Material Material [EXT/INT] Matériel	AISI 430							
Espesor Thickness Épaisseur	55							
Aislamiento Isolation Isolation	40kg/m ³ / Free CFC's / Zero ODP-GWP							
Capacidad Capacity Capacité	490		1070		490	1070	490	1070
Puertas Doors Portes	1	2	2	4	1	2	1	2
Nº estantes Nº shelves Nº d'étagères	3		6		3	6	3	6
Sistema de frío Cooling System Système de froid	Forzado / Forced air / Ventilé							
Desescarche Defrost Dégivrage	Parada compresor / Compressor off / Arrêt du compresseur				Gas caliente / Hot gas / Gaz chaud		Parada compresor / Compressor off / Arrêt du compresseur	
Expansión Expansion Expansion	Capilar / Capillary / Capillaire							
Potencia Power Puissance	265		435		625	905	285	475
Potencia frig. Cooling capacity Puissance Frig.	370		690		540	720	370	690
Consumo Consumption Consommation	1,58		3,04		6,70	11,85	-	-
Clase energética Energy class Classe Énerg.	C				D		-	
Refrigerante Refrigerant Gaz	R-290							
Opcional Optional Options	Parrilla / Wire shelf / Grille [502X14] Ruedas / Casters / Roulettes [705X16=2; 705X17=2] 115V/1ph/60Hz 230V/1ph/60Hz							

NEW

Series / Série IAN 500/1000

+Info: www.infrico.com

IAN1002 CR



3 parrillas por puerta
3 shelves per door
3 grilles par porte

Puerta con doble acristalamiento [6-15-5]
Double glazed door [6-15-5]
Portes double vitrage [6-15-5]



IAN501



IAN1002N

Controlador digital IP 65.
Digital control IP65
Contrôleur digital IP 65.

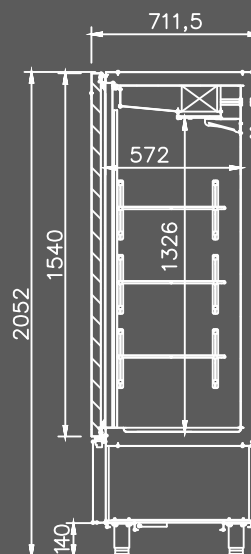

Armario refrigeración, congelación y puertas de cristal / Reach in refrigerators, freezers and glass door / Armoires positives, négatives et portes vitrées

	REFRIG / REFRIG / POSIT		CONGEL / FREEZ / NÉGAT		REFRIG / REFRIG / POSIT	
MODELO MODELE MODÈLE	IAG701	IAG1402	IAG701N	IAG1402N	IAG701CR	IAG1402CR
Precio Price Prix						
Medidas Measures [mm] Mesures	687 x 838 x 2060 mm.	1387 x 838 x 2060 mm.	687 x 838 x 2060 mm.	1387 x 838 x 2060 mm.	687 x 838 x 2060 mm.	1387 x 838 x 2060 mm.
Temperatura Temperature Température [°C]	-2°C/+8°C		-18°C		+2°C/+6°C	
Clase Climática Climatic class Classe climatique [°C]	4 / 38°C					
Tensión/Frecuencia Electrical data Tension électrique	230V/1ph/50Hz					
Controlador Controller Régulateur	Digital IP65					
Material Material [EXT/INT] Matériel	AISI 430					
Espesor Thickness Épaisseur [mm]	55					
Aislamiento Isolation Isolation [mm]	40kg/m ³ / Free CFC's / Zero ODP-GWP					
Capacidad Capacity Capacité [L]	580	1280	580	1280	580	1280
Puertas Doors Portes	1	2	1	2	1	2
Nº estantes Nº shelves Nº d'étagères	3	6	3	6	3	6
Sistema de frío Cooling System Système de froid	Forzado / Forced air / Ventilé					
Desescarche Defrost Dégivrage	Parada compresor / Compressor off / Arrêt du compresseur		Gas caliente / Hot gas / Gaz chaud		Parada compresor / Compressor off / Arrêt du compresseur	
Expansión Expansion Expansion	Capilar / Capillary / Capillaire		Válvula de expansión termostática / Thermostatic expansion valve / Valve d'expansion thermostatique		Capilar / Capillary / Capillaire	
Potencia Power Puissance [W]	265	445	625	905	285	495
Potencia frig. Cooling capacity Puissance Frig. [W A -10°C]	370	690	540	720	370	690
Consumo Consumption Consommation [kWh/ 24h]	2,5	3,3	8,45	15,21	-	
Clase energética Energy class Classe Énerg.	D	C	C	D	-	
Refrigerante Refrigerant Gaz	R-290					
Opcional Optional Options	Parrilla / Wire shelf / Grille [530X650mm] [502X14] Juego de guías GD / Slides GD / Jeu de Glisières GD [GUIAL0115641; GUIAL0215641] Ruedas / Casters / Roulettes [705X16=2; 705X17=2] Juego de guías / Slides / Jeu de Glisières GN 2/1 650x450 [GUIA01UAGB/GUIA02UAGB] Juego de guías / Slides / Jeu de Glisières 600x400 [GUIAL01641P/GUIAL02641P] 115V/1ph/60Hz 230V/1ph/60Hz					

NEW

Series / Série **IAG 700/1400**

+Info: www.infrico.com

IAG701



Controlador digital IP 65.
Digital control IP65
Contrôleur digital IP 65.



Puerta con doble acristalamiento [6-15-5]
Double glazed door [6-15-5]
Portes double vitrage [6-15-5]

OPCIONAL
OPTIONAL
OPTIONAL

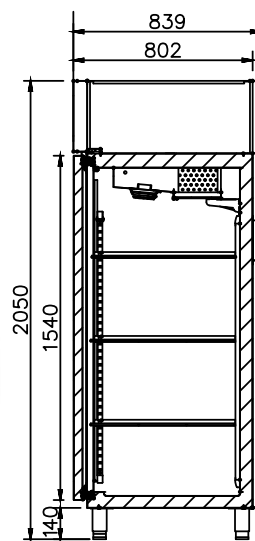

IAG1402CR

6. Línea Americana

American Line / Ligne Americaine

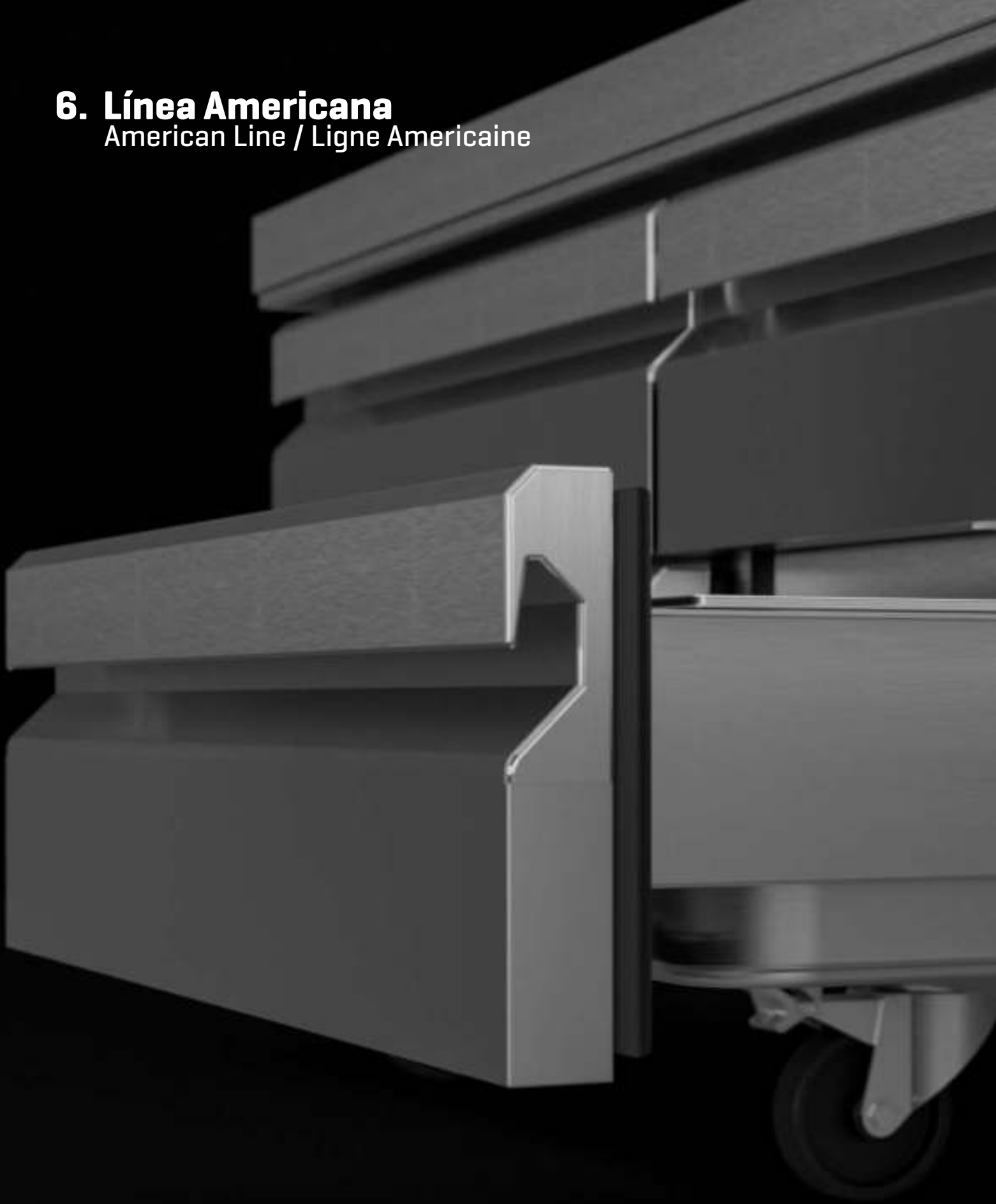

 Infrico



6. Línea Americana

American Line / Ligne Americaine





6. Línea Americana

American Line / Ligne Americaine

SOPORTA HASTA
HOLDS UP TO
SUPPORTE JUSQU'À
450Kg
MSG 72, 96, 110

SOPORTA HASTA
HOLDS UP TO
SUPPORTE JUSQU'À
300Kg
MSG 36, 48, 52

Doble acristalamiento templado, bajo emisoro con carga de Argón (4-27-4).

Double tempered glass, low-e with argon charge (4-27-4).

Triple vitrage et verre trempé (4-12-3-12-4).

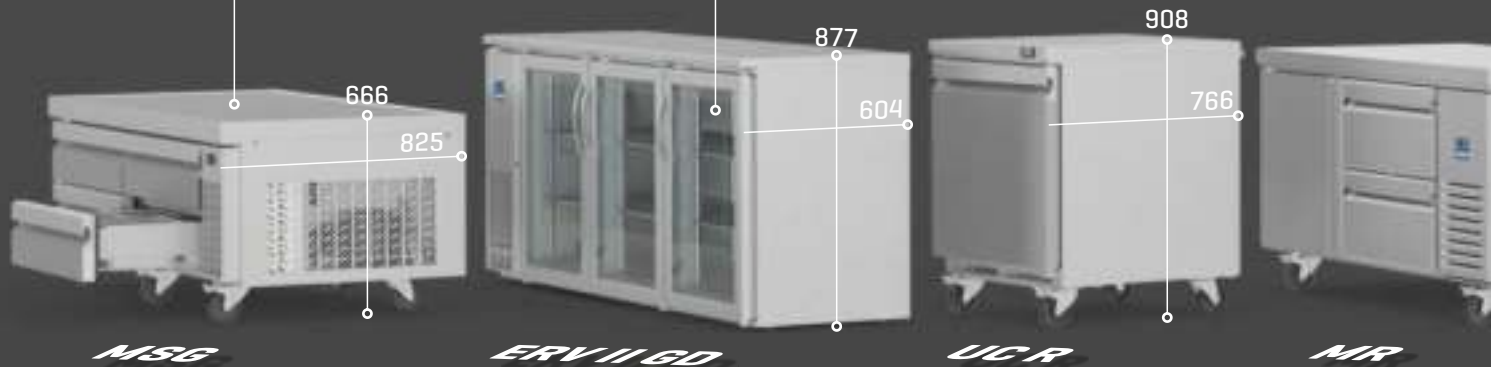

Iluminación / Lighting / Éclairage

Incorporación de iluminación LED, llegando a reducir el consumo energético entre un 80% y 90%, respecto a una bombilla tradicional.
RGB opcional.

LED lighting incorporated, reducing energetic consumption between 80% and 90% respect to a traditional light bulb.
RGB optional.

Éclairage LED, réduisant la consommation énergétique entre 80% et 90%, par rapport à une ampoule traditionnelle.
RGB optionnel.



+Info: www.infrico.com

Tiradores ergonómicos.
Ergonomic handles.
Poignées ergonomiques.



Ruedas incluidas
[excepto en ERV] /

Casters included
[except ERV] /

Roues incluses
[sauf ERV]



6. Línea Americana

American Line / Ligne Americaine

Serie / Series / Série

GN 2/1 **Armario de refrigeración y congelación GN2/1** **182 - 183**
Reach in refrigerator and freezer GN2/1 / Armoire positive et négative GN2/1

Serie / Series / Série

UC **Mesa undercounter refrigeración y congelación** **184 - 185**
Undercounter refrigerator and freezer / Table undercounter positive et négative

Serie / Series / Série

CAJONES **Mesa undercounter refrigeración con cajones** **184 - 185**
Drawered undercounter refrigerator / Table undercounter positive avec tiroirs

Serie / Series / Série

UC **Mesa undercounter refrigeración para ensaladas** **186 - 187**
Sandwiches salad prep tables / Table undercounter positive préparation salade

Serie / Series / Série

UC-PMT **Mesa undercounter refrigeración para ensaladas/sandwiches megatop** **188 - 189**
Salads/sandwiches megatop undercounter
Table undercounter positive préparation salades/sandwiches megatop

Serie / Series / Série

MR **Mesa refrigeración y congelación** **190 - 191**
Deep undercounter refrigerator and freezer / Table positive et négative

Serie / Series / Série

MR-EN **Mesa refrigeración ensaladas y pizza** **190 - 191**
Pizza salad prep tables / Table positive préparation salade et pizza

Serie / Series / Série

CHEF BASES **Mesa baja refrigeración** **192 - 193**
Chef base refrigerator / Soubassement positif

Serie / Series / Série

BACK BAR **Frente mostrador refrigerado** **194 - 195**
Back bar cooler / Arrière bar

+Info: www.infrico.com

Serie / Series / Série
GN 2/1



AN 23 **AN 49** **AN 67** | **AN 23 BT** **AN 49 BT** **AN 67 BT** | **AN 49 MX** | **AN 23 CR** **AN 49 CR** **AN 67 CR**
REFRIG / REFRIG / POSIT | CONGEL / FREEZ / NÉGAT | MIXTO
MIXED
MIXTE | REFRIG / REFRIG / POSIT

Serie / Series / Série
UC / CAJONES



UC 27 R **UC 48 R** **UC 60 R** **UC 72 R** **UC 27 F** **UC 48 F** **UC 60 F** **UC 27 D** **UC 48 D** **UC 60 D**
CAJONES / DRAWERS / TIROIRS

UC 27 P **UC 48 P** **UC 60 P** **UC 72 P** **UC 27 P 2D** **UC 48 P 4D** **UC 60 P 4D**
REFRIGERACIÓN / REFRIGERATOR / POSITIVE

Serie / Series / Série
UC - PMT



UC 27 PMT **UC 48 PMT** **UC 60 PMT** **UC 72 PMT**
REFRIGERACIÓN / REFRIGERATOR / POSITIVE

Serie / Series / Série
MR / MR-EN



MR 41 **MR 67** **MR 93** | **MR 41 BT** **MR 67 BT** | **MR 41 EN** **MR 67 EN** **MR 93 EN** **MR 119 EN**
REFRIG / REFRIG / POSIT | CONGEL / FREEZ / NÉGAT | REFRIG / REFRIG / POSIT

Serie / Series / Série
CHEF BASES



MSG36 **MSG48** **MSG52** **MSG72** **MSG96** **MSG110**
REFRIGERACIÓN / REFRIGERATOR / POSITIVE

Serie / Series / Série
BACK BAR



ERV36IISD **ERV60IISD** **ERV84IISD** **ERV36IIGD** **ERV60IIGD** **ERV84IIGD**
REFRIGERACIÓN / REFRIGERATOR / POSITIVE

Armarios de refrigeración GN2/1 / GN2/1 Reach in refrigerator / Armoire positive GN2/1

REFRIG / REFRIG / POSIT

CONGEL / FREEZ / NÉGAT

MIXTO
DUAL TEMP.
MIXTE

REFRIG / REFRIG / POSIT

MODELO
MODELE
MODÈLE

AN 23

AN 49

AN 67

AN 23 BT

AN 49 BT

AN 67 BT

AN 49 MX

AN 23 CR

AN 49 CR

AN 67 CR

	AN 23	AN 49	AN 67	AN 23 BT	AN 49 BT	AN 67 BT	AN 49 MX	AN 23 CR	AN 49 CR	AN 67 CR
Precio Price Prix										
Medidas Measures Mesures [mm]	687 x 796 x 2112 mm.	1384 x 796 x 2112 mm.	2081 x 796 x 2112 mm.	687 x 796 x 2112 mm.	1384 x 796 x 2112 mm.	2081 x 796 x 2112 mm.	1384 x 796 x 2112 mm.	687 x 796 x 2112 mm.	1384 x 796 x 2112 mm.	2081 x 796 x 2112 mm.
Temperatura Temperature Température [°C]		-2°C/+8°C			-18°C		-2°C/+8°C -18°C		+2°C / +6°C	
Clase Climática Climatic class Classe climatique [°C]		5 / 40° C				4 / 38° C				
Tensión/Frecuencia Electrical data Tension électrique	230V/1ph/50Hz									
Controlador Controller Régulateur	Digital									
Material Material [EXT/INT] Matériel	Ext/Int: AISI 430									
Espesor Thickness Épaisseur [mm]	55									
Aislamiento Isolation Isolation [mm]	40kg/m ³ / Free CFC's / Zero ODP-GWP									
Capacidad Capacity Capacité [L]	610	1350	1886	610	1350	1886	610+610	610	1350	1886
Puertas Doors Portes	1	2	3	1	2	3	2	1	2	3
N° parrillas / Guías N° shelves / Slides N° de grilles / Glissière	3/3 [650x530]	6/6 [650x530]	9/9 [650x530]	3/3 [650x530]	6/6 [650x530]	9/9 [650x530]	6/6 [650x530]	4/4 [650x530]	8/8 [650x530]	12/12 [650x530]
Desescarche Defrost Dégivrage	Parada de compresor / Compresor off / Arrêt du compresseur			Gas caliente / Hot gas / Gaz chaud			Parada comp[+] Gas cal[-] Compresor off[-] Hot gas[-] Arrêt comp[+] Gaz chaud[-]	Parada de compresor / Compresor off / Arrêt du compresseur		
Expansión Expansion Expansion	Capilar / Capillary / Capillaire			Válvula termostática / Expansion valve / Détendeur thermostatique			Capilar[+] V. Exp[-] Cap[+] Exp. valve[-] Cap[+] V. d'exp[-]	Capilar / Capillary / Capillaire		
Potencia Power Puissance [W]	267	455	460	662	640	1362	1330	460	495	650
Potencia frig. Cooling capacity Puissance Frig. [W A] [-10° / 30°C BT]	343	690	690	639	742	1278	690/640	690	690	934
Consumo Consumption Consommation [kWh/ 24h]	1,50	1,93	3,40	6,86	10,16	16,08		-		
Clase energética Energy class Classe Énerg.	B	A	B	C	D	C		-		
Refrigerante Refrigerant Gaz	R-290									
Opcional Optional Options	<p>Juego de guías / Slides / Jeu de Glissières [GUIAAN60] Patas / Legs / Pieds [506X42] 115V/1ph/60Hz 230V/1ph/60Hz</p> <p>Parrilla / Wire shelf / Grille [502X14]</p> <p>Parrilla reforzada / Reinforced wire shelf Grille renforcée [502x91] Led RGB (por puerta) / Led RGB (per door) LED RGB (par porte)</p>									

Serie / Series / Série **GN 2/1**

+Info: www.infrico.com

AN 67 CR



Doble acristalamiento 6-15-5
Double glass 6-15-5
Double vitrage 6-15-5



AN 49 BT



Cerradura incorporada
Included lock
Serrure de série



Rejilla inferior
Bottom grill side
Grille inférieure

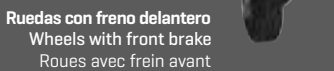

Ruedas con freno delantero
Wheels with front brake
Roues avec frein avant

Led RGB Opcional
Led RGB Optional
Led RGB Options



Parrilla reforzada
Reinforced wire shelf
Grille renforcée

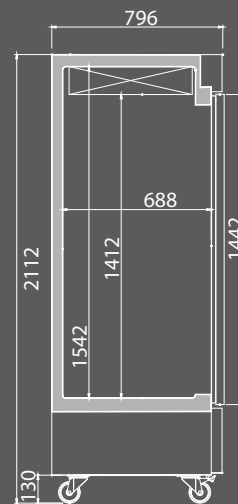
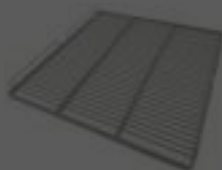

Mesas undercounter de refrigeración y congelación / Undercounter refrigerators and freezers / Table undercounter positive et négative

REFRIG / REFRIG / POSIT

CONGEL / FREEZ / NÉGAT

REFRIG / REFRIG / POSIT

CAJONES / DRAWERS / TIROIRS

MODELO MODELE MODÈLE	UC 27 R	UC 48 R	UC 60 R	UC 72 R	UC 27 F	UC 48 F	UC 60 F	UC 27 2D	UC 48 4D	UC 60 4D
Precio Price Prix										
Medidas Measures Mesures (mm)	702 x 766 x 908 mm.	1227 x 766 x 908 mm.	1533 x 766 x 908 mm.	1844 x 766 x 908 mm.	702 x 766 x 908 mm.	1227 x 766 x 908 mm.	1533 x 766 x 908 mm.	702 x 766 x 908 mm.	1227 x 766 x 908 mm.	1533 x 766 x 908 mm.
Temperatura Temperature Température (°C)	-2°C/+8°C				-18°C			-2°C/+8°C		
Clase Climática Climatic class Classe climatique (°C)	4 / 38° C									
Tensión/Frecuencia Electrical data Tension électrique	230V/1ph/50Hz									
Material Material Matériel (EXT/INT)	Ext/Int - Ext/Int - Ext/Int: AISI 430 Encimera / Worktop / Plan du travail: AISI 304									
Espesor Thickness Épaisseur (mm)	55									
Capacidad Capacity Capacité (L)	200	380	480	590	200	380	480	200	380	480
Puertas/Cajones Doors/Drawers Tiroirs	1	2		3	1	2		2	4	
Nº parrillas J. guías N° shelves / Slides N° de grilles / Glissière	2/2 [570x437]	4/4 [540x437]	4/4 [693x437]	6/6 [570x437] [540x437]	2/2 [570x437]	4/4 [540x437]	4/4 [693x437]	-	-	-
Desescarche Defrost Dégivrache	-				Gas caliente / Hot gas / Gaz chaud			-		
Potencia Power Puissance (W)	205		364		410	507	637	205		
Potencia frig. Cooling capacity Puissance Frig. (W A) [-10° -30° et]	370		690		306		445	370		
Consumo Consumption Consommation (kWh/ 24h)	1,21	1,70	1,83	2,25	2,53	3,27	4,11	1,21	1,70	1,83
Clase energética Energy class Classe Énerg.	A						B	A		
Refrigerante Refrigerant Gaz	R-290									
Opcional Optional Options	Parrilla / Wire shelf / Grille UC27 [502X73] Parrilla / Wire shelf / Grille UC48 [502X74] Parrilla / Wire shelf / Grille UC60 [502X75] Cerradura / Lock / Serrure [506X120; 506X121]							-		
	Patas / Legs / Pieds [506X42] 115V/1ph/60Hz 230V/1ph/60Hz									

Serie / Series / Série **UC**

+Info: www.infrico.com

UC 72 R



Encimera acero inox AISI 304
AISI 304 stainless steel worktop
Plan de travail en AISI 304

Sistema de ventilación frontal
Front breathing refrigeration system
Système de ventilation frontale

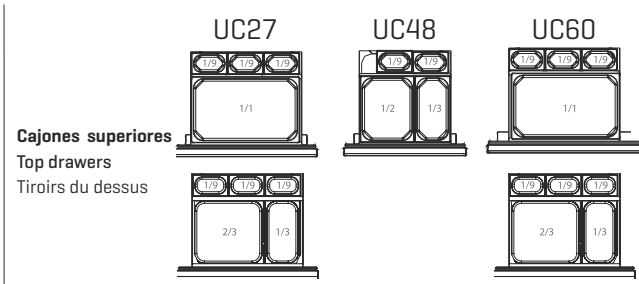
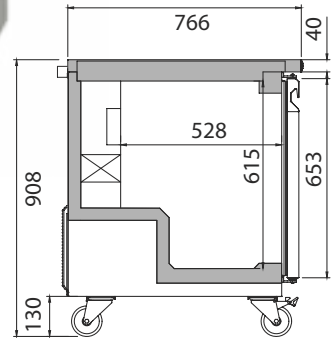

Cada cajón UC incluye una barra divisoria para las distintas configuraciones de bandejas. Hay otras barras disponibles en caso de cambio de la distribución.

Each UC drawer includes one divider bar for different pan configurations. Other divider bars are available for varying size pan distribution.

Chaque tiroir UC comprend une barre de séparation pour différentes configurations de bacs. D'autres barres de séparation sont disponibles pour la répartition de bacs de taille variable.

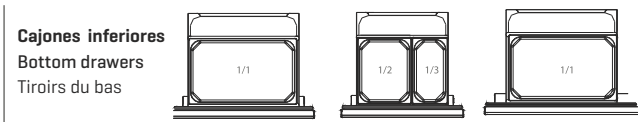

Cajones no incluidos / Drawers not included / Tiroirs non inclus



Cajones con guías telescópicas con salida mayorada y sistema de autocierre.
Drawers with telescopic guides for complete opening and self closing system.
Tiroirs avec glissières télescopiques avec ouverture facile et système de fermeture automatique.

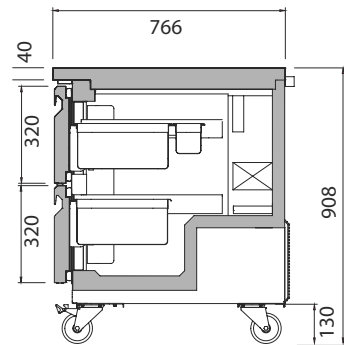







Mesas undercounter de refrigeración para ensaladas

Salads prep tables undercounters /

Table undercounter positive préparation salade

REFRIGERACIÓN / REFRIGERATOR / POSITIVE

MODELO MODELE MODÈLE							
	UC 27 P	UC 48 P	UC 60 P	UC 72 P	UC 27 P 2D	UC 48 P 4D	UC 60 P 4D
Precio Price Prix							
Medidas Measures Mesures (mm)	702 x 766 x 1175 mm.	1227 x 766 x 1175 mm.	1533 x 766 x 1175 mm.	1844 x 766 x 1175 mm.	702 x 766 x 1175 mm.	1227 x 766 x 1175 mm.	1533 x 766 x 1175 mm.
Temperatura Temperature Temperature (°C)	0°C/+6°C						
Clase Climática Climatic class Classe climatique (°C)	4 / 38° C						
Tensión/Frecuencia Electrical data Tension électrique	230V/1ph/50Hz						
Material Material Matériel (EXT/INT)	Ext/Int - Ext/Int - Ext/Int: AISI 430 Respaldo / Back / Arrière: Acero galvanizado / Galvanized steel / Acier galvanisée Encimera / Worktop / Plan du travail: AISI 304						
Espesor Thickness Épaisseur (mm)	55						
Capacidad Capacity Capacité (L)	200	380	480	590	200	380	480
Puertas Doors Portes	1	2		3	2	4	
Nº parrillas J. guías Nº shelves / Slides Nº de grilles / Glissière	2/2 [570x437]	4/4 [540x437]	4/4 [693x437]	6/6 [570x437] [540x437]	-		
Nº Bandejas Nº Pans Nº Containers	6	12	16	18	6	12	16
Evaporación Evaporation Evaporation	Ventilado / Ventilated / Ventilé						
Desescarche Defrost Dégivrache	-						
Potencia Power Puissance (W)	205			364	205		
Potencia frig. Cooling capacity Puissance Frig. (W A -10°C)	370			690	370		
Refrigerante Refrigerant Gaz	R-290						
Opcional Optional Options	Tapa plana / Flat lid / Couvercle plat UC 27 P [TAPUC27PF] Tapa plana / Flat lid / Couvercle plat UC 48 P [TAPUC48PF] Tapa plana / Flat lid / Couvercle plat UC 60 P [TAPUC60PF] Tapa plana / Flat lid / Couvercle plat UC 72 P [TAPUC72PF] Patas / Legs / Pieds [506X42] 115V/1ph/60Hz 230V/1ph/60Hz						

Serie / Series / Série **UC**

+Info: www.infrico.com



Combinación de bandejas / Incluidas
Pans combinations / Included
Combinaison de bacs / Inclus

UC 27 P

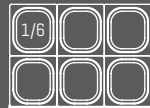

UC 48 P

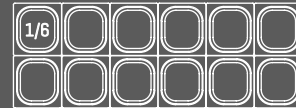

UC 60 P

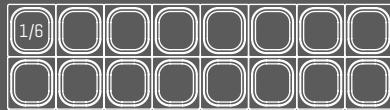

UC 72 P

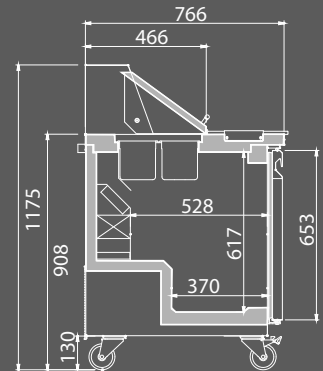
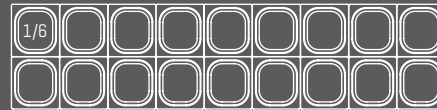

UC 60 P 4D



UC 27 P 2D





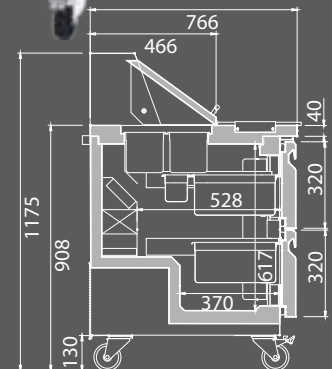

Tabla de corte
Cutting board
Table à découper



Mesas undercounter de refrigeración para ensaladas-sandwiches megatop / Salads-sandwiches megatop undercounter / Table undercounter positive préparation salades-sandwiches megatop

REFRIGERACIÓN / REFRIGERATOR / POSITIVE

MODELO MODELE MODÈLE				
	UC 27 PMT	UC 48 PMT	UC 60 PMT	UC 72 PMT
Precio Price Prix				
Medidas Measures Mesures (mm)	702 x 866 x 1246 mm.	1227 x 866 x 1246 mm.	1533 x 866 x 1246 mm.	1844 x 866 x 1246 mm.
Temperatura Temperature Temperature (°C)	0°C/+6°C			
Clase Climática Climatic class Classe climatique (°C)	4 / 38° C			
Tensión/Frecuencia Electrical data Tension électrique	230V/1ph/50Hz			
Material Material Matériel (EXT/INT)	Ext/Int - Ext/Int - Ext/Int: AISI 430 Encimera / Worktop / Plan du travail: AISI 304			
Espesor Thickness Épaisseur (mm)	55			
Capacidad Capacity Capacité (L)	200	380	480	590
Puertas Doors Portes	1	2		3
Nº parrillas J. guías N° shelves / Slides N° de grilles / Glissière	2 [570x437]	4 [540x437]	4 [693x437]	6 [540x437] [570x437]
Nº Bandejas N° Pans N° Containers	9	18	24	27
Evaporación Evaporation Evaporation	Ventilado / Ventilated / Ventilé			
Desescarche Defrost Dégivrache	-			
Potencia Power Puissance (W)	205		364	
Potencia frig. Cooling capacity Puissance Frig. (W A -10°C)	370		690	
Refrigerante Refrigerant Gaz	R-290			
Opcional Optional Options	Tapa plana / Flat lid / Couvercle plat UC 27 PMT [TAPUC27PMTF] Tapa plana / Flat lid / Couvercle plat UC 48 PMT [TAPUC48PMTF] Tapa plana / Flat lid / Couvercle plat UC 60 PMT [TAPUC60PMTF] Tapa plana / Flat lid / Couvercle plat UC 72 PMT [TAPUC72PMTF] Patas / Legs / Pieds [506X42] 115V/1ph/60Hz 230V/1ph/60Hz			

Serie / Series / Série **UC-PMT**

+Info: www.infrico.com

UC 72 PMT



UC 27 PMT



UC 60 PMT

Combinación de bandejas / Incluidas
Pans combinations / Included
Combinaison de bacs / Inclus

UC 27 PMT

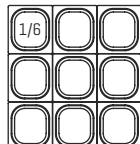

UC 48 PMT

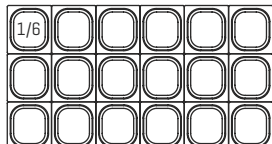

UC 60 PMT

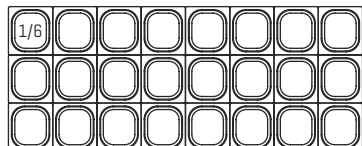

UC 72 PMT

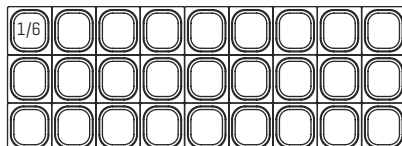

Tapa plana opcional
Flat lid optional
Couvercle plat en option

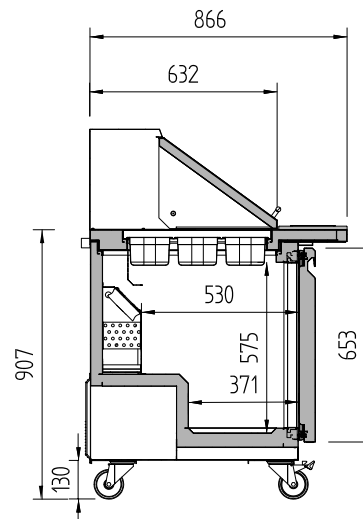

Mesas de refrigeración y congelación / Deep undercounter refrigerator and freezer / Table positive et négative (MR - MR BT)

Mesas refriger. ensaladas y pizzas / Pizza salad prep tables / Table positive prép. salades et pizzas (MR EN)

REFRIG / REFRIG / POSIT

CONGEL / FREEZ / NÉGAT

REFRIG / REFRIG / POSIT

MODELO
MODELE
MODÈLE



MR 41

MR 67

MR 93

MR 41 BT

MR 67 BT

MR 41 EN

MR 67 EN

MR 93 EN

MR 119 EN

Modelo / Modèle / Modèle	MR 41	MR 67	MR 93	MR 41 BT	MR 67 BT	MR 41 EN	MR 67 EN	MR 93 EN	MR 119 EN
Precio Price Prix									
Medidas Measures Mesures (mm)	1050 x 830 x 840 mm.	1710 x 830 x 840 mm.	2370 x 830 x 840 mm.	1050 x 830 x 840 mm.	1710 x 830 x 840 mm.	1050 x 830 x 1022 mm.	1710 x 830 x 1022 mm.	2370 x 830 x 1022 mm.	3030 x 830 x 1022 mm.
Temperatura Temperature Temperature (°C)	-2°C / +8°C			-18°C		0°C/+6°C			
Clase Climática Climatic class Classe climatique (°C)	5 / 40° C			4 / 38° C					
Tensión/Frecuencia Electrical data Tension électrique	230V/1ph/50Hz								
Material Material Matériel (EXT/INT)	AISI 430 Encimera / Worktop / Dessus AISI 304								
Espesor Thickness Épaisseur (mm)	55								
Capacidad Capacity Capacité (L)	220	480	765	220	480	220	480	765	1050
Puertas Doors Portes	1	2	3	1	2	1	2	3	4
N° parrillas J. guías N° shelves / Slides N° de grilles / Glissière	2 (510 x 650)	4 (510 x 650)	6 (510 x 650)	2 (510 x 650)	4 (510 x 650)	2 (510 x 650)	4 (510 x 650)	6 (510 x 650)	8 (510x650)
N° Bandejas N° Pans N° Containers	-					5	9	13	16
Evaporación Evaporation Evaporation	Ventilado / Ventilated / Ventilé								
Desescarche Defrost Dégivrache	Parada compresor / Compresor off / Arrêt compresseur.			Gas caliente / Hot gas / Gaz chaud		Parada compresor / Compresor off / Arrêt compresseur.			
Potencia Power Puissance (W)	212	370		458	678	370		504	
Potencia frig. Cooling capacity Puissance Frig. (W A) (-10°/30°C BT)	370	690		445	580	690		950	
Refrigerante Refrigerant Gaz	R-290								
Opcional Optional Options	Parrilla / Wire shelf / Grille (502X77) Patas / Legs / Pieds (506X42) Kit cajones / Drawer kit / Kit tiroirs (JCAJ10MR442C) 115V/1ph/60Hz 230V/1ph/60Hz Juego de Guías / Set of Sliders / Jeu de Glissières (GUIA503MR01: GUIA503MR02)								

Serie / Series / Série **MR / MR-EN**

+Info: www.infrico.com

MR 119 EN

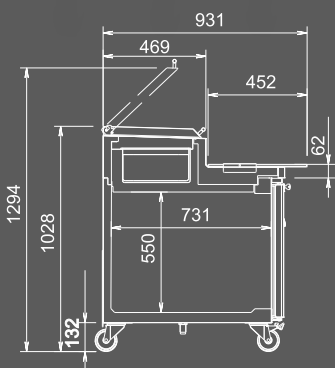

Combinación de bandejas / Incluidas
Pans combinations / Included
Combinaison de bacs / Inclus

Tabla de corte polietileno
Polyethylene cutting board
Table à découper en polyéthylène



Kit cajones opcional
Optional drawers kit
Kit tiroirs en option

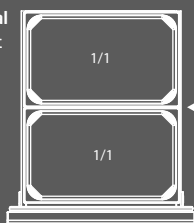

Barra divisoria opcional
Optional divider bar
Barre de division en option

Cod: 10UC2749

Cod: 10UC27134

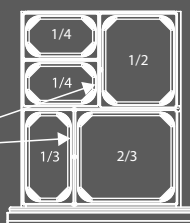

Control digital protegido con desescarche
Protected digital control with defrost
Contrôleur digital protégé avec dégivrage



Cerradura de serie
Standard door lock
Serrure de série





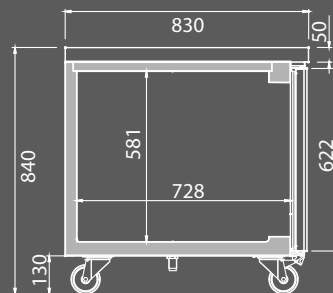

MR 67 BT

Encimera acero inox AISI 304
AISI 304 Stainless steel worktop
Dessus acier inox AISI 304



Mesa baja refrigeración / Chef base refrigerator / Soubassement positif

REFRIGERACIÓN / REFRIGERATOR / POSITIVE

MODELO MODELE MODÈLE						
	MSG36	MSG48	MSG52	MSG72	MSG96	MSG110
Precio Price Prix						
Medidas Measures Mesures (mm)	930 x 825 x 666 mm.	1235 x 825 x 666 mm.	1352 x 825 x 666 mm.	1845 x 825 x 666 mm.	2464 x 825 x 666 mm.	2809 x 825 x 666 mm.
Temperatura Temperature Temperature (°C)	0°C/+6°C					
Clase Climática Climatic class Classe climatique (°C)	4 / 38° C					
Tensión/Frecuencia Electrical data Tension électrique	230V/1ph/50Hz					
Material Material Matériel (EXT/INT)	Ext/Int AISI 430 Encimera / Worktop / Dessus AISI 304					
Espesor Thickness Épaisseur (mm)	55					
Capacidad Capacity Capacité (L)	148	193	280	405	584	620
Cajones Drawers Tiroirs	2			4		6
Nº parrillas J. guías N° shelves / Slides N° de grilles / Glissière	4		6	8	12	
Nº Bandejas N° Pans N° Containers	2 GN1/1 + GN1/6		GN1/1			
Evaporación Evaporation Evaporation	Ventilado / Ventilated / Ventilé					
Desescarche Defrost Dégivrache	Parada de compresor / Compressor off / Arrêt du compresseur					
Potencia Power Puissance (W)	440			480	640	
Potencia frig. Cooling capacity Puissance Frig. (W A -10°C)	370				690	
Refrigerante Refrigerant Gaz	R-290					
Opcional Optional Options	Patas / Legs / Pieds [506X42] 115V/1ph/60Hz 230V/1ph/60Hz					

Serie / Series / Série **CHEF-BASES**

+Info: www.infrico.com

MSG96



Encimera acero inox AISI 304 con reborde de protección

AISI 304 Stainless steel worktop with protective flange

Dessus acier inox AISI 304 avec bride de protection



Marine Edge

MSG52

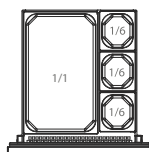

MSG36

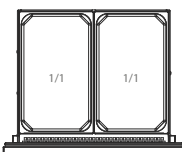

MSG48/72/110

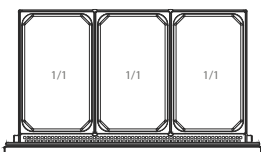

MSG52/96

Barra divisoria en opción
Optional divider bar
Barre de division en option

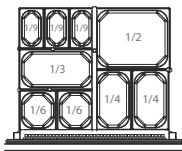

Cada cajón UC incluye una barra divisoria para las distintas configuraciones de bandejas. Hay otras barras disponibles en caso de cambio de la distribución.

Each UC drawer includes one divider bar for different pan configurations. Other divider bars are available for varying size pan distribution.

Chaque tiroir UC comprend une barres de séparation pour différentes configurations de bacs. D'autres barres de séparations sont disponibles pour la répartition de bacs de taille variable.

Encimera embutida con filo en V
Stamped worktop with "V" edge
Plan de travail embouti en "V"



**SOPORTA HASTA
HOLDS UP TO
SUPPORTE JUSQU'À**
450Kg
MSG 72, 96, 110







**SOPORTA HASTA
HOLDS UP TO
SUPPORTE JUSQU'À**
300Kg
MSG 36, 48, 52



Guías telescópicas, hasta 200 kg.
Drawers with telescopic guides up to 200 Kg.
Glissières d'auto fermeture telescopique qui peuvent supporter jusqu'à 200 Kg.

Frente mostrador refrigerado / Back bar coolers / Arrière bar

REFRIGERACIÓN / REFRIGERATOR / POSITIF

MODELO MODELE MODÈLE						
	ERV36IISD	ERV60IISD	ERV84IISD	ERV36IIGD	ERV60IIGD	ERV84IIGD
Precio Price Prix						
Medidas Measures Mesures [mm]	922 x 604 x 877 mm.	1543 x 604 x 877 mm.	2164 x 604 x 877 mm.	922 x 604 x 877 mm.	1543 x 604 x 877 mm.	2164 x 604 x 877 mm.
Temperatura Temperature Température [°C]	-2°C/+8°C			2°C/+6°C		
Clase Climática Climatic class Classe climatique [°C]	4 / 38° C					
Tensión/Frecuencia Electrical data Tension électrique	230V/1ph/50Hz					
Material Material [EXT/INT] Matériel	Ext/Int AISI 430					
Espesor Thickness Épaisseur [mm]	55					
Capacidad Capacity Capacité [L]	162	362	562	162	362	562
Puertas Doors Portes	1	2	3	1	2	3
Nº parrillas J. guías N° shelves / Slides N° de grilles / Glissière	2 [487x465]	4 [487x465] [610x465]	6 [487x465]	2 [487x465]	4 [487x465] [610x465]	6 [487x465]
Desescarche Defrost Dégivrache	Parada de compresor / Compressor off / Arrêt du compresseur					
Potencia Power Puissance [W]	215	235	395	225	265	435
Potencia frig. Cooling capacity Puissance Frig. [W A -10°C]	370		690	370		690
Consumo Consumption Consommation [kWh/ 24h]	1,85	2,75	3,70	-		
Clase energética Energy class Classe Énerg.	B	C	C	-		
Refrigerante Refrigerant Gaz	R-290					
Opcional Optional Options	Iluminación Led RGB con cambio de color (por puerta) / Led lighting RGB change of colour (per door) / LED RGB avec changement de couleur (par porte) 115V/1ph/60Hz 230V/1ph/60Hz					

Serie / Series / Série **BACK BAR**

+Info: www.infrico.com

ERV84IIGD



Grifo no disponible
Beer tap not available
Pompe et futs non disponibles



Cerradura de serie
Serial Lock
Serrure de série

ERV36IIGD

Control digital protegido con desescarche
Protected digital control with defrost
Contrôleur digital protégé avec dégivrage



7. Cava & Dry Aging

 Infrico





7. Cava & Dry Aging



+Info: www.infrico.com



7. Cavas & Dry Aging

Doble acristalamiento templado, bajo emisor con carga de Argón [4-27-4].

Double tempered glass, low-e with argon charge [4-27-4].

Triple vitrage et verre trempé [4-12-3-12-4].



Control electrónico de Temperatura y Humedad.

Electronic Temperature and Humidity control.

Contrôle électronique de la Température et de l'Humidité.



Iluminación / Lighting / Éclairage

Incorporación de iluminación LED, llegando a reducir el consumo energético entre un 80% y 90%, respecto a una bombilla tradicional. RGB opcional.

LED lighting incorporated, reducing energetic consumption between 80% and 90% respect to a traditional light bulb. RGB optional.

Éclairage LED, réduisant la consommation énergétique entre 80% et 90%, par rapport à une ampoule traditionnelle. RGB optionnel.



+Info: www.infrico.com

Barra carnicera.

Meat bar set.

Barre à viande.



Modelos MDA en inox AISI304 y MDAB en acero lacado negro.

Models MDA in AISI304 stainless steel and MDAB in black lacquered steel.

Modèles MDA en inox AISI304 et MDAB en acier laqué noir.



Parrillas / Grills / Grilles

Parrillas de acero lacado y madera.

Painted steels and wood grills.

Grilles en acier et en bois.



Opcional: parrillas de madera.

Optional: wood grills.

En option: Grilles en bois



7. Cavas & Dry Aging

Serie / Series / Série

AN SC

Secadero de embutidos

Seasoning refrigerator / Armoire séchage affinage

204 - 205

Serie / Series / Série

AGB MDA

Armario de maduración Dry Aging

Dry Aging meat cabinet / Armoire de maturation Dry Aging

206 - 207

Serie / Series / Série

NEW

VC MDA

Vitrina cerrada de maduración

Dry Aging meat display case / Vitrine de maturation Dry Aging

208 - 209

Serie / Series / Série

NEW

AC MDAB

Armario mediano de maduración Dry Aging

Dry Aging meat medium cabinet / Armoire moyenne de maturation Dry Aging

210 - 211

Serie / Series / Série

AMC

Armario de maduración Dry Aging

Dry Aging meat cabinet / Armoire de maturation Dry Aging

212 - 213

Serie / Series / Série

VITRA V

Armarios expositores de vino

Whines exhibiting cupboard / Armoire d'exposition pour le vin

216 - 217

Serie / Series / Série

EVV

Expositor de vino en madera

VINTAGE

Wine cellars and retro-wine cellars / Armoire à vin et gourmet

218 - 219

+Info: www.infrico.com

Serie / Series / Série

AN SC



AN501 SC



AN1002 SC

Serie / Series / Série

AGB MDA



AGB701MDA



AGB1402MDA



AGB701MDA B



AGB1402MDA B

Serie / Series / Série

VC MDA



VC 1400 MDA



VC 1400 MDAB



VC 2010 MDA



VC 2010 MDAB

Serie / Series / Série

AC MDAB



AC 280 MDAB

Serie / Series / Série

AMC



AMC6711L



AMC6714L



AMC8711L



AMC8714L



AMC6711XL



AMC6714XL



AMC8711XL



AMC8714XL

Serie / Series / Série

VITRA V



L06511V



L06512V



L06513V



L06514V



L08511V



L08512V



L08513V



L08514V

Serie / Series / Série

**EVV
VINTAGE**



EVV100



EVV200MX



EVV 23 R1G



EVV 49 R2G

Armario secadero embutidos / Seasoning refrigerator / Armoire séchage affinage

SECADERO / SEASONING / SÉCHAGE



AN501 SC



AN1002 SC

MODELO MODELE MODÈLE	AN501 SC	AN1002 SC
Precio Price Prix		
Medidas Measures [mm] Mesures	687 x 700 x 2060 mm.	1385 x 700 x 2060 mm.
Temperatura Temperature Température	+4°C/+16°C	
Clase Climática Climatic class Classe climatique	4 / 38°C	
Tensión/Frecuencia Electrical data Tension électrique	230V/1ph/50Hz	
Controlador Controller Régulateur	Digital IP65	
Material Material [EXT/INT] Matériel	AISI 304	
Espesor Thickness Épaisseur	55	
Aislamiento Isolation Isolation	40kg/m ³ / Free CFC's / Zero ODP-GWP	
Capacidad Capacity Capacité	500	1110
Puertas Doors Portes	1	2
N° parrillas / Guías N° shelves / Slides N° de grilles / Glissière	-	-
Barra carnicera Bars for meat set N° bars à viande	3	6
Sistema de frío Cooling System Système de froid	Forzado / Forced air / Ventilé	
Desescarche Defrost Dégivrage	Parada de compresor / Compresor off / Arrêt du compresseur	
Expansión Expansion Expansion	Capilar / Capillary / Capillaire	
Potencia Power Puissance	750	915
Potencia frig. Cooling capacity Puissance Frig.	370	690
Consumo Consumption Consommation	-	-
Refrigerante Refrigerant Gaz	R-290	
Opcional Optional Options	Juego de guías / Slides AN 500 [GUIAC0315470] Juego de guías / Slides AN 1000 [GUIAC0115520; GUIAC0215520] 115V/1ph/60Hz 230V/1ph/60Hz Puerta de cristal / Glass door / Porte vitrée [PUE17DGAEX-PUE17IGAEX] Cerradura / Lock / Serrure [506X209; 506X210] Barra carnicera / Meat bar set / Barre à viande [BCSEC3] [BCSEC4]	

Serie / Series / Série **AN 500/1000L**

+Info: www.infrico.com

AN 1002 SC



Video del producto

Product Video

Vidéo du produit



Infrico Youtube

Control electrónico de Temperatura y Humedad
 Electronic Temperature and Humidity control
 Contrôle électronique de la Température et de l'humidité

25 Kg por puerta
 25 Kg per door
 25 Kg par porte

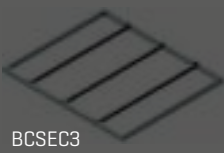

BCSEC3

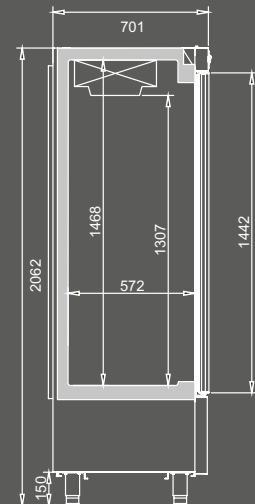

Armario madurador Dry Aging / Dry Aging meat cabinet / Armoire maturation Dry Aging

MODELO
MODELE
MODÈLE



AGB701MDA



AGB1402MDA



AGB701MDA B



AGB1402MDA B

Precio Price Prix				
Medidas Measures [mm] Mesures		687 x 868 x 2130 mm.	1385 x 868 x 2130 mm.	687 x 868 x 2130 mm.
Temperatura Temperature Température	[°C]	T° 0°C/+16°C		
Clase Climática Climatic class Classe climatique	[°C]	4 / 38°C		
Tensión/Frecuencia Electrical data Tension électrique		230V/1ph/50Hz		
Controlador Controller Régulateur		Digital IP65		
Material Material [EXT/INT] Matériel		AISI 304		Int: AISI 304 Ext: Acero Lacado Negro / Black Lacquered Steel / Acier Laqué Noir
Espesor Thickness Épaisseur	[mm]	75		
Aislamiento Isolation Isolation	[mm]	40kg/m ³ / Free CFC's / Zero ODP-GWP		
Capacidad Capacity Capacité	[L]	560	1240	560
Puertas Doors Portes		1	2	1
N° parrillas / Guías N° shelves / Slides N° de grilles / Glissière		1 barra / meat bar / barre à viande 2 estantes / shelves / étagères	2 barra / meat bar / barre à viande 4 estantes / shelves / étagères	1 barra / meat bar / barre à viande 2 estantes / shelves / étagères
Sistema de frío Cooling System Système de froid		Forzado / Forced air / Ventilé		
Desescarche Defrost Dégivrage		Parada de compresor / Compressor off / Arrêt du compresseur		
Expansión Expansion Expansion		Capilar / Capillary / Capillaire		
Potencia Power Puissance	[W]	870	1380	870
Potencia frig. Cooling capacity Puissance Frig.	[W A -10°C]	370	690	370
Consumo Consumption Consommation	[kWh/ 24h]	6,35	7,34	6,35
Clase energética Energy class Classe Énerg.		-		
Refrigerante Refrigerant Gaz		R-290		
Opcional Optional Options		Manejo control digital bluetooth o wifi / Operating digital control bluetooth or wifi / Trait. de contrôle digital bluetooth ou wifi		115V/1ph/60Hz
		Ruedas / Casters / Roulettes [705X16=2; 705X17=2]		230V/1ph/60Hz
		Barra carnicera / Meat bar set / Barre à viande [BCAN] Esterilizador UVC + Ozono / UVC + Ozone Steriliser / Stérilisateur UVC + Ozone Estantes adicionales / Additional shelves / Étagères supplémentaires		

Serie / Series / Série **AGB MDA**

+Info: www.infrico.com

AGB1402MDA



Video del producto

Product Video

Vidéo du produit



Infrico Youtube



Led de serie con tonalidad especial para carne.
Standard LEDs with a special meat tone.
LEDs standard avec une tonalité spéciale viande.



AGB701MDAB

Controlador digital con control de temperatura, humedad y teclado táctil.
Digital controller with temperature, humidity control and touch keyboard.
Contrôleur digital tactile, avec contrôle de la température et de l'humidité.

Control electrónico de Temperatura y Humedad
Electronic Temperature and Humidity control
Contrôle électronique de la Température et de l'humidité

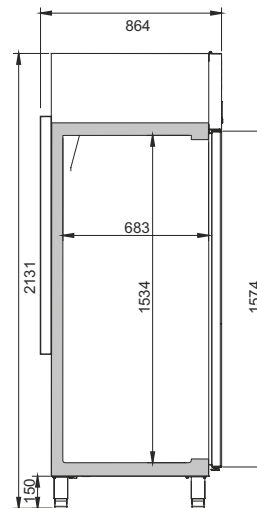

Vitrina de maduración Dry Aging / Dry Aging meat display case / Vitrine maturation Dry Aging



VC 1400 MDA



VC 1400 MDAB



VC 2010 MDA

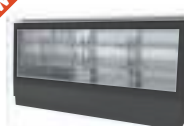

VC 2010 MDAB

MODELO MODELE MODÈLE	VC 1400 MDA	VC 1400 MDAB	VC 2010 MDA	VC 2010 MDAB
Precio Price Prix				
Medidas Measures [mm] Mesures	1384 x 740 x 1060 mm.	1384 x 740 x 1060 mm.	2100 x 740 x 1060 mm.	2100 x 740 x 1060 mm.
Temperatura Temperature Température	+0°C/+16°C			
Clase Climática Climatic class Classe climatique	4 / 38°C			
Tensión/Frecuencia Electrical data Tension électrique	230V/1ph/50Hz			
Controlador Controller Régulateur	Digital IP65			
Material Material [EXT/INT] Matériel	AISI 304	Int + tapa/lid/couvercle: AISI 304 Ext: Acero Lacado Negro / Black Lacquered Steel / Acier Laqué Noir	AISI 304	Int + tapa/lid/couvercle: AISI 304 Ext: Acero Lacado Negro / Black Lacquered Steel / Acier Laqué Noir
Espesor Thickness Épaisseur	70			
Aislamiento Isolation Isolation	40kg/m ³ / Free CFC's / Zero ODP-GWP			
Capacidad Capacity Capacité	470	470	710	710
Puertas Doors Portes	1	1	1	1
Nº Estantes Shelves Nº Étagères	4	4	6	6
Barra carnicera Bars for meat set Nº bars à viande	-	-	-	-
Sistema de frío Cooling System Système de froid	Forzado / Forced air / Ventilé			
Desescarche Defrost Dégivrage	Parada de compresor / Compresor off / Arrêt du compresseur			
Expansión Expansion Expansion	Capilar / Capillary / Capillaire			
Potencia Power Puissance	551	551	557	557
Potencia frig. Cooling capacity Puissance Frig.	687	687	687	687
Consumo Consumption Consommation	-	-	-	-
Refrigerante Refrigerant Gaz	R-290			
Opcional Optional Options	<p>Puerta de cristal Glass door (unit) Porte vitrée (unité) (Dcha.-Right-Droite) KPUIDVCCR (Izq.-Left-Gauche) KPUIIVCCR</p> <p>Cerradura puerta ciega Solid door lock Serrure porte inox (506X120; 506X121)</p> <p>Cerradura puerta cristal Glass door lock Serrure porte vitrée (506X60)</p>			

NEW

...e / Series / Série VC

+Info: www.infrico.com

VC 2010 MDAB



Led de serie con tonalidad especial para carne.
Standard LEDs with a special meat tone.
LEDs standard avec une tonalité spéciale viande.



Puerta abatible para un acceso y limpieza más fácil.
Swing door for easy access and cleaning.
Porte battant pour un accès et un nettoyage faciles.

VC 1400 MDA



Puertas traseras de retorno automático,
y bisagra con bloqueo.
Automatic return rear doors,
and locking hinge.
Portes arrière à retour automatique,
et charnière de blocage.

VC 2010 MDA

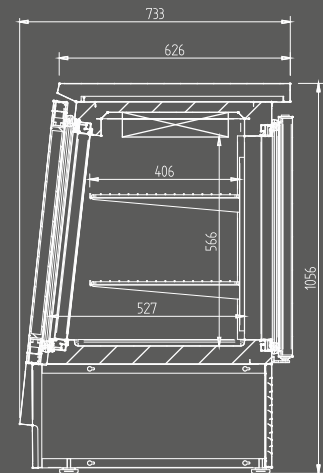

Armario madurador Dry Aging / Dry Aging meat cabinet / Armoire maturation Dry Aging



MODELO
MODELE
MODÈLE

AC 280 MDAB

Precio Price Prix	
Medidas Measures [mm] Mesures	600 x 656 x 1645 mm.
Temperatura Temperature Température	T° +0°C/+16°C Humedad / humidity / humidité 45% HR / 85% HR
Clase Climática Climatic class Classe climatique	4 / 38°C
Tensión/Frecuencia Electrical data Tension électrique	230V/1ph/50Hz
Controlador Controller Régulateur	Digital IP65
Material Material [EXT/INT] Matériel	Int: AISI 304 Ext: Acero Lacado Negro / Black Lacquered Steel / Acier Laqué Noir
Espesor Thickness Épaisseur	50
Aislamiento Isolation Isolation	40kg/m ³ / Free CFC's / Zero ODP-GWP
Capacidad Capacity Capacité	340
Puertas Doors Portes	1
N° Estantes Shelves N° Étagères	3
Sistema de frío Cooling System Système de froid	Forzado / Forced air / Ventilé
Desescarche Defrost Dégivrage	Parada de compresor / Compresor off / Arrêt du compresseur
Expansión Expansion Expansion	Capilar / Capillary / Capillaire
Potencia Power Puissance	720
Potencia frig. Cooling capacity Puissance Frig.	343
Consumo Consumption Consommation	-
Clase energética Energy class Classe Énerg.	-
Refrigerante Refrigerant Gaz	R-290
Opcional Optional Options	Manejo control digital bluetooth o wifi / Operating digital control bluetooth or wifi / Trait. de contrôle digital bluetooth ou wifi Estantes adicionales / Additional shelves / Étagères supplémentaires Ruedas / Casters / Roulettes (705X16=2; 705X17=2) 115V/1ph/60Hz 230V/1ph/60Hz

NEW

/ Series / Série **AC**

+Info: www.infrico.com

AC 280 MDAB

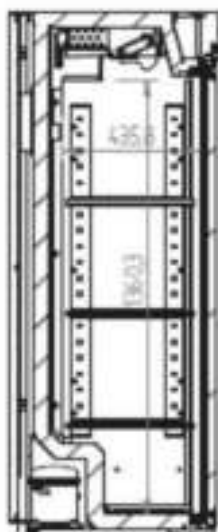

Led de serie con tonalidad especial para carne.
Standard LEDs with a special meat tone.
LEDs standard avec une tonalité spéciale viande.

Control electrónico de Temperatura y Humedad
Electronic Temperature and Humidity control
Contrôle électronique de la Température et de l'humidité



Armario de maduración de carne / Dry-aging meat cabinets / Armoire de maturation pour la viande



MODELO/MODELE/MODÈLE	AMC6711L	AMC6714L	AMC8711L	AMC8714L	AMC6711XL	AMC6714XL	AMC8711XL	AMC8714XL
Precio Price Prix								
Medidas Measures [mm] Mesures	650 650 1900	650 650 1900	850 650 1900	850 650 1900	650 650 2300	650 650 2300	850 650 2300	850 650 2300
Tensión/Frecuencia Electrical data [V/Hz] Tension électrique	220/50							
Material Material Matériel	Triple cristal sin perfilera en aluminio, excepto puerta en doble cristal. Tratamiento para evitar entrada de rays U.V.A. Triple glazing without aluminum profiles, except door in double glazing. Treatment to avoid U.V.A rays. Triple vitrage sans profilera en aluminium, sauf porte double vitrage. Traitement pour éviter l'entrée des rayons U.V.A.							
Capacidad Capacity Capacité	450		600			780		
Caras de cristal Glass sides Faces vitrées	1	4	1	4	1	4	1	4
Puertas Doors Portes	1	1	1	1	1	1	1	1
Temperatura Temperature [30°C] Température	+2°C / +6°C							
Potencia Power [W] Puissance	992	992	997	997	1260	1260	1265	1265
Refrigerante Refrigerant Gaz	HC R290							
Opcional Optional Options	<p>[MODEL L] Kit ensamblaje [1 Kit cada 2 armarios] / Assembly kit [1 kit per 2 cupboards] / Kit de montage [1 kit pour 2 armoires] [MODEL XL] Kit ensamblaje [1 Kit cada 2 armarios] / Assembly kit [1 kit per 2 cupboards] / Kit de montage [1 kit pour 2 armoires]</p> <p>(mod. 650x1900 mm) Decor. Negra/Blanca/Brown Rusty / Decor. Black/White/Brown Rusty / Décor. noire/blanche/Marron Rusty (mod. 850x1900 mm) Decor. Negra/Blanca/Brown Rusty / Decor. Black/White/Brown Rusty / Décor. noire/blanche/Marron Rusty (mod. 650x2300 mm) Decor. Negra/Blanca/Brown Rusty / Decor. Black/White/Brown Rusty / Décor. noire/blanche/Marron Rusty (mod. 850x2300 mm) Decor. Negra/Blanca/Brown Rusty / Decor. Black/White/Brown Rusty / Décor. noire/blanche/Marron Rusty</p>  <p>Kit SIN MADURACIÓN / Kit WITHOUT DRY AGING / Kit SANS MATURATION</p>							

A DESTACAR

La maduración en seco es una técnica de envejecimiento en seco de la carne con temperatura y humedad controladas. Con la maduración en seco, la carne en 5-8 semanas pierde del 10% al 20% de los líquidos.

La vitrina Dry Aged trabaja en un régimen de temperatura de +2°C a +6°C con humedad controlada del 45% al 80%.

Gama de armarios diseñados para la maduración de la Carne [+2 °C a +6 °C], con sistema de refrigeración ventilado.

Termostato SOFT TOUCH con pantalla gráfica de 2.8" y teclado táctil, control de humedad de serie.

Disponible en dos longitudes 650mm y 850mm, grupo frigorífico en la parte inferior AMC 67/87L o superior AMC67/87XL.

Doble barra carnicera y tres estantes de acero cromado o cristal [a elegir].

Modelos canalizables, hasta un máximo de 2 puertas. Estructura con ruedas.

Iluminación con doble tira de LED, tonalidad especial para carne.

BENEFITS

Dry ripening is a dry aging technique of meat with controlled temperature and humidity. With the maturation in dry, the meat in 5-8 weeks loses from 10% to 20% of the liquids.

The Dry Aged showcase works in a field of +2°C +6°C with controlled humidity of 45% to 80%.

Range of cabinets designed for the dry-aging meat [+ 2°C to + 6 °C], with ventilated cooling system.

SOFT TOUCH thermostat with 2.8 "graphic display and touch screen, humidity control standard.

Available in two lengths 650mm and 850mm, refrigeration unit in the lower part AMC 67/87L and in the upper part AMC67/87XL.

Double meat bar and and three chromed or glass shelves [free choice].

Modularity, there is the possibility of channeling different models independently of their size with the Assembly Kit, up to a maximum of 2 doors.

Structure with wheels.

Lighting with double LED strip, special tonality for meat.

À SOULIGNER

Gamme d'armoires conçue pour la maturation de la viande [+2°C jusqu'à +6°C], avec système de réfrigération ventilé.

Nouveau thermostat SOFT TOUCH avec écran graphique de 2,8" et clavier tactile interactif, contrôle d'humidité de série.

Finition standard SILVER QUARTZ, ou sur commande en NOIR OPAL et BLANC PERLE.

Disponible en deux longueurs 650mm et 850mm, groupe frigorifique en bas AMC 67/87L ou en haut AMC 67/87XL.

Modularité, il existe la possibilité de canaliser différents modèles indépendamment de leur dimension grâce à kit de montage, maximum 3 portes.

Structure avec roulettes.

Éclairage avec double LED spécial pour viande.

Serie / Series / Série **AMC**

+Info: www.infrico.com

AMC8714XL

**Modelo con unidad
frigorífica arriba
Negro Opcional**

Model with
refrigeration unit
on top
Black Optional

Modèle avec
unité de
refroidissement
au-dessus.
Noir en option



AMC6714XL

**Modelo Estándar
Silver Quartz**

Standard model
Silver Quartz

Modèle Standard
Silver Quartz





+Info: www.infrico.com



Armarios expositores de vino / Wines exhibiting cupboard / Armoire d'exposition pour le vin



MODELO/MODELE/MODÈLE	L06511V	L06512V	L06513V	L06514V	L08511V	L08512V	L08513V	L08514V
Precio Price Prix								
Medidas Measures (mm) Mesures	650 650 2300	650 650 2300	650 650 2300	650 650 2300	850 650 2300	850 650 2300	850 650 2300	850 650 2300
Tensión/Frecuencia Electrical data (V/Hz) Tension électrique	220/50							
Material Material Matériel	Triple cristal excepto la puerta en doble cristal, cristal exterior e interior bajo emisivo. Triple crystal except the door in double glass, exterior glass and interior low emissive. Triple vitrage à l'exception de la porte qui est en double vitrage, vitrage extérieur et intérieur de faible émissivité.							
Capacidad Capacity Capacité	600 [120 Botellas]				780 [160 Botellas]			
Caras de cristal Glass sides Faces vitrées	1	2	3	4	1	2	3	4
Puertas Doors Portes	1	1	1	1	1	1	1	1
Estantes Shelves Étagères	3	3	3	3	3	3	3	3
Temperatura Temperature (30°C) Température	+4°C / +18°C							
Condensación Condensation Condenseur	Ventilada / Ventilated / Ventilée							
Evaporación Evaporation Évaporateur	Ventilada / Ventilated / Ventilée							
Desescarche Defrost (Kg.) Dégivrage	Automático / Automatic / Automatique							
Potencia Power (W) Puissance	1260	1260	1260	1260	1265	1265	1265	1265
Refrigerante Refrigerant Gaz	HC R290							
Opcional Optional Options	<p>Kit ensamblaje [1 Kit cada 2 armarios] / Assembly kit [1 kit per 2 cupboards] / Kit de montage [1 kit tous les 2 coffrets]</p> <p>Estructura plexiglás 90° [120 botellas] / 90° plexiglass structure [120 bottles] / Structure en plexiglas 90° [120 bouteilles]</p> <p>Estructura plexiglás 45° [66 botellas] / 45° plexiglass structure [66 bottles] / Structure en plexiglas 45° [66 bouteilles]</p> <p>Decoración Negra/Blanca/Brown Rusty / Decoration Black/White/Brown Rusty / Décoration noire/blanche/Marron Rusty [mod. 650 mm]</p> <p>Decoración Negra/Blanca/Brown Rusty / Decoration Black/White/Brown Rusty / Décoration noire/blanche/Marron Rusty [mod. 850 mm]</p>							

A DESTACAR

Gama de armarios expositores de Vino [+4°C a +18°C].
Disponibles en dos longitudes 650mm y 850mm, con posibilidad de 1 a 4 caras de cristal.
Tres estantes de plexiglás regulables en altura, medidas 500x450mm (longitud 650mm), y medida 700x450mm (longitud 850mm).
Capacidad de hasta 120 botellas o 160 botellas según modelo.
Modelos canalizables hasta un máximo de 3 puertas.
Estructura con ruedas.
Iluminación con doble tira de LED con luz continua, mejora la visibilidad del producto expuesto.

BENEFITS

Range of wine display cabinets [+4°C to +18°C].
Available in two lengths 650mm and 850mm, with the possibility of 1 to 4 faces of glass.
Three plexiglass shelves adjustable in height, measured 500x450mm (length 650mm), and measurement 700x450mm (length 850mm).
Capacity up to 120 bottles or 160 bottles according to model.
Canalisable models up to a maximum of 3 doors.
Structure with wheels.
Double LED strip lighting with continuous light, improves the visibility of the exposed product.

À SOULIGNER

Gamme d'armoires d'exposition pour le vin [+4°C jusqu'à +18°C].
Disponibles en deux largeurs 650mm et 850mm, avec possibilité de 1 à 4 faces vitrées.
Distribution intérieure avec 3 étagères de plexiglas réglables en hauteur, dimensions 500x450mm (longueur 650mm), et dimensions 700x450mm (longueur 850mm).
Capacité jusqu'à 120 bouteilles ou 160 bouteilles selon modèle.
Modèles canalissables, maximum 3 portes.
Structure avec roulettes.
Éclairage avec double LED et lumière continue pour une meilleure visibilité du produit exposé.

Serie / Series / Série **VITRA V**

+Info: www.infrico.com



[longitud 850 mm,
altura 1900 mm]
Consultar precio

[wide 850 mm,
height 1900 mm]
Price to consult

[850mm longueur,
hauteur 1900mm]
Consulter prix

**Combinación de Armarios
Kit ensamblaje**
Combination of cabinets
Assembly kit
Combinaison d'armoires
Kit d'assemblage

L08513V + L08513V

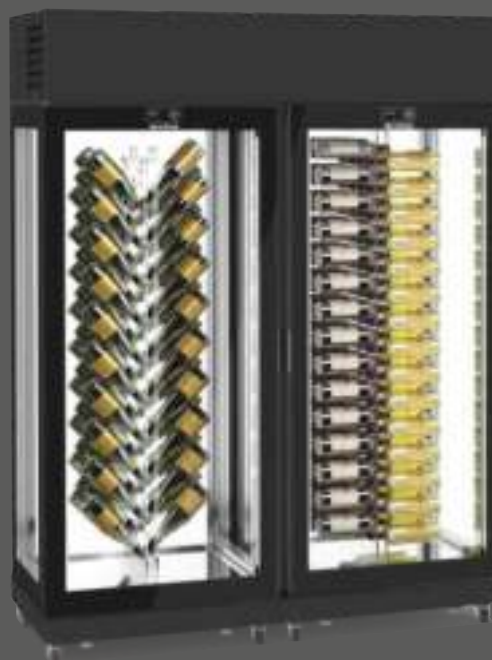

Opción / Option / Option
**Estructura plexiglás 90° y 45°
sólo para modelos de longitud 850mm**

Plexiglass structure 90° y 45°
only for wide 850mm models

Option structure 90° et 45° plexiglas
seulement disponible armoires de 850 mm



[650 mm longitud,
altura 2300 mm]
[wide 650 mm,
height 2300 mm]
[650mm longueur,
hauteur 2300mm]



[650 mm longitud,
altura 2300 mm]
[wide 650 mm,
height 2300 mm]
[650mm longueur,
hauteur 2300mm]

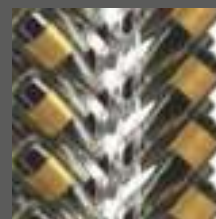

**Termostato
Soft touch
Thermostat tactile**

L06511V

L06514V

Expositor de vino en madera / Wine cellars / Armoire à vin

Expositor de vino en madera / Retro-wine cellars / Armoire à vin et gourmet

Exterior de madera maciza [Cerezo] / Solid wood exterior [Cherry] / Extérieur en bois massif [Cerisier]



EVV100





EVV200MX



EVV 23 R1G



EVV 49 R2G

MODELO MODELE MODÈLE	EVV100	EVV200MX	EVV 23 R1G	EVV 49 R2G
Precio Price Prix				
Medidas Measures [mm] Mesures	657 x 596 x 1918 mm.	1314 x 596 x 1918 mm.	690 x 602 x 2032 mm.	1385 x 602 x 2032 mm.
Temperatura Temperature Température	+4°C/+18°C			
Clase Climática Climatic class Classe climatique	4 / 38°C			
Tensión/Frecuencia Electrical data Tension électrique	230V/1ph/50Hz			
Controlador Controller Régulateur	Digital / Digital / Électronique IP65			
Material Material Matériel [EXT/INT]	100% Madera de pino maciza / 100% Pine wood / 100% en bois de pin massif Acero plastificado gris / Grey plastic coated steel / Acier plastifié gris		100% Madera de pino maciza / 100% Pine wood / 100% en bois de pin massif Interior AISI 430 / Inetrior AISI 430 / Intérieure AISI 430	
Espesor Thickness Épaisseur	50		95	
Aislamiento Isolation Isolation	40kg/m ³ / Free CFC's / Zero ODP-GWP			
Capacidad Capacity Capacité	350	350+350	265	640
Puertas Doors Portes	1	2	1	2
N° parrillas / Guías N° shelves / Slides N° de grilles / Glissière	7	14	5	10
Capacidad botellas Bottle rack Nombre de bouteilles	100	100 + 100	90	90 + 90
Sistema de frío Cooling System Système de froid	Forzado / Forced air / Ventilé			
Desescarche Defrost Dégivrage	Parada de compresor / Compressor off / Arrêt du compresseur			
Expansión Expansion Expansion	Capilar / Capillary / Capillaire			
Potencia Power Puissance	335	785	255	440
Potencia frig. Cooling capacity Puissance Frig.	370		370	690
Consumo Consumption Consommation	-			
Refrigerante Refrigerant Gaz	R-290			
Opcional Optional Options	 Cerezo / Cherry / Cerisier Estándar / Standard / Standard		 Negro / Black / Noir RAL 9017 [EVV23R1G] [EVV49R2G]	
			 Blanco / White / Blanc RAL 9016 [EVV23R1G] [EVV49R2G]	
			115V/1 ph/60 Hz 230V/1 ph/60 Hz	
			Parrilla de madera / Wooden shelves / Gril en bois [PMADAR1P]	

Serie / Series / Série **EVV / VINTAGE**

+Info: www.infrico.com

EVV200MX

Negro opcional
Optional black
Noir en option



Doble temperatura
Dual temperature
Double température

Video del producto
Product Video
Vidéo du produit



Infrico Youtube

**La temperatura recomendada para el Vino Tinto está entre 10°C y 18°C .
Blanco, Rosado y Brut entre 4°C y 8°C.**

Recommended temperature for red wine is 10°C to 18°C.
White, rosé and brut is 4°C to 8°C.

La température recommandée, vin rouge entre 10°C à 18°C.
Blanc, Rosé et Brut entre 4°C à 8°C.



EVV100

EVV 49 R2G





8. Vitrinas Expositoras

Display cases / Vitrines d'exposition

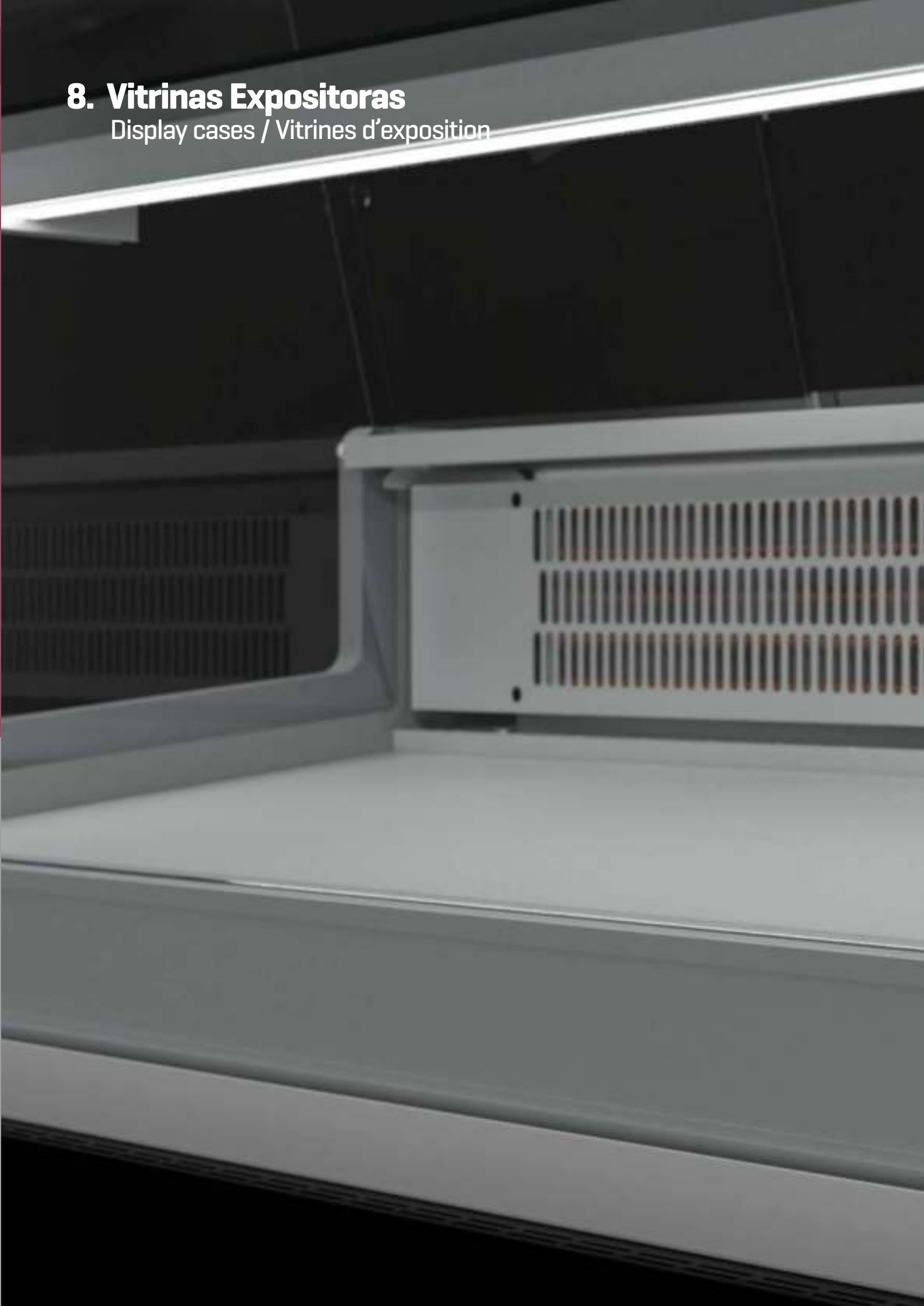

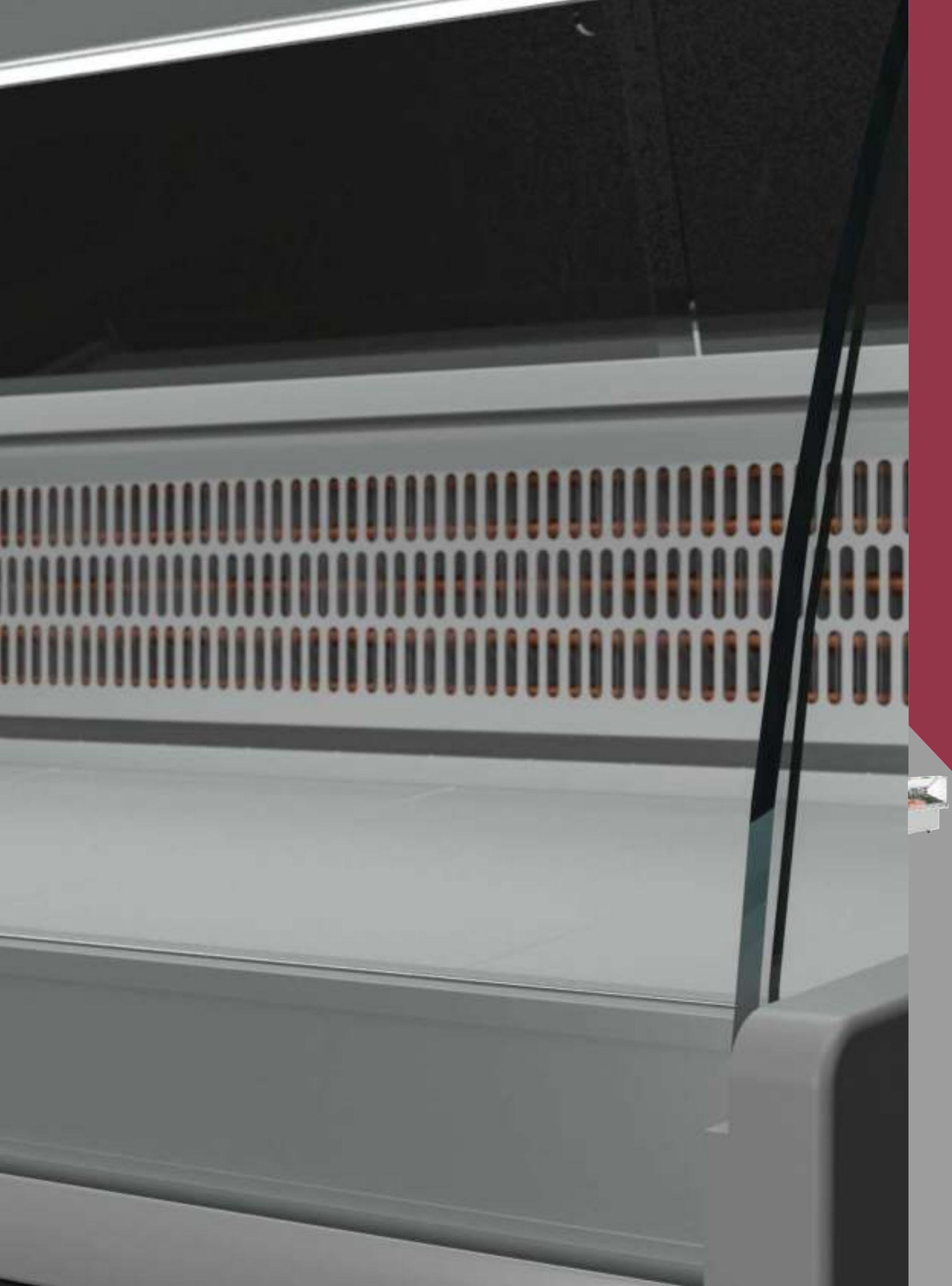

8. Vitrinas Expositoras

Display cases / Vitrines d'exposition



+Info: www.infrico.com



8. Vitrinas Expositoras

Display cases / Vitrines d'exposition

Estructura de cristales de alta transparencia, rectos o curvos según modelo.

High transparency glass structure, flat or curved depending on the model.

Structure en verre à haute transparence, droite ou bombée selon le modèle.

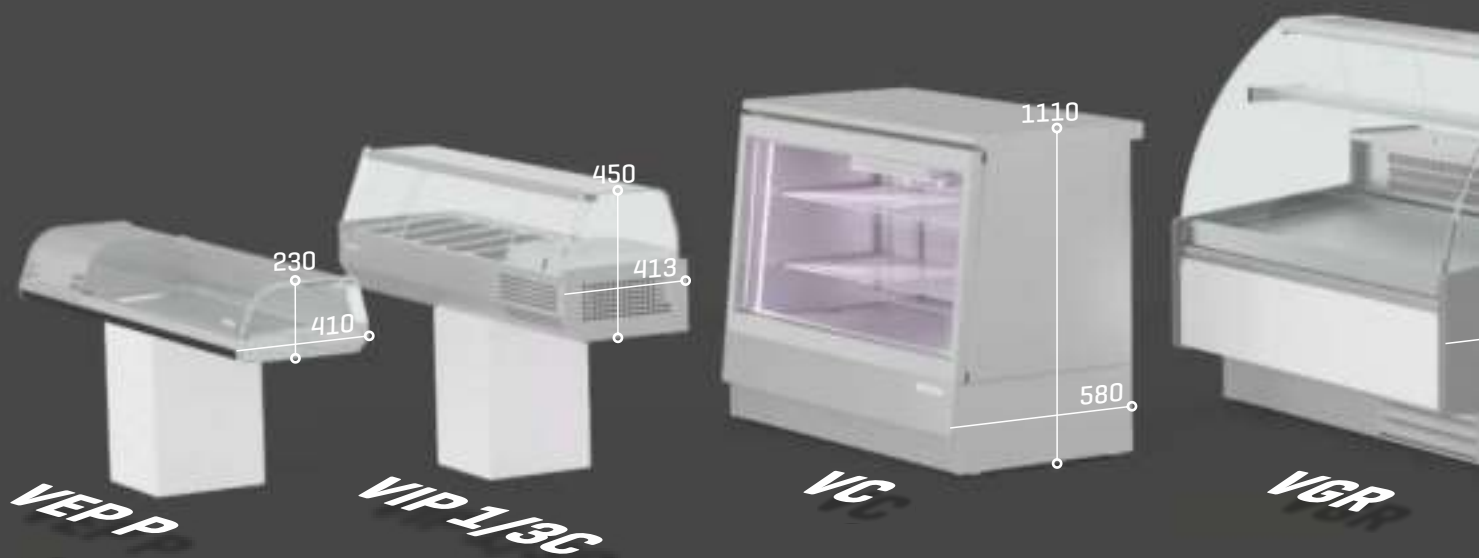

Iluminación / Lighting / Éclairage

Incorporación de iluminación LED, llegando a reducir el consumo energético entre un 80% y 90%, respecto a una bombilla tradicional.

LED lighting incorporated, reducing energetic consumption between 80% and 90% respect to a traditional light bulb.

Éclairage LED, réduisant la consommation énergétique entre 80% et 90%, par rapport à une ampoule traditionnelle.



+Info: www.infrico.com

Equipos con posibilidad de grupo remoto y grupo incorporado.

Devices with the possibility of remote group and integrated group.

Équipement avec la possibilité de groupe à distance et de groupe incorporé.

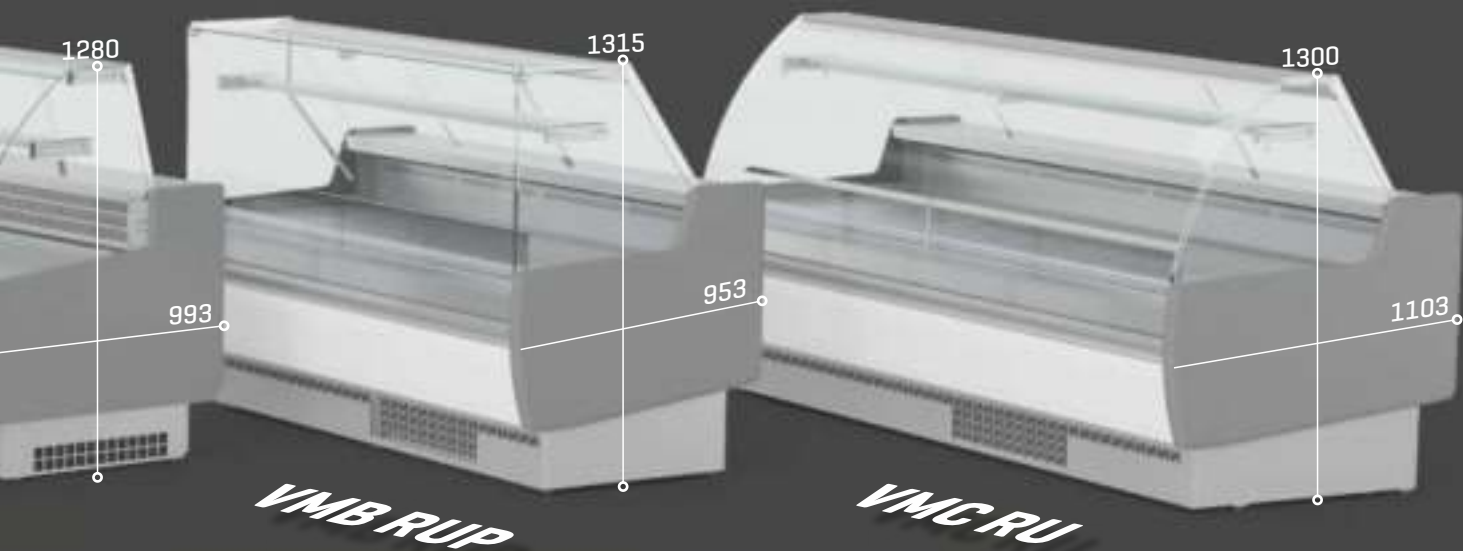

Máxima visibilidad de producto expuesto.

Maximum visibility of displayed product.

Visibilité maximale du produit exposé.



8. Vitrinas Expositoras













Display cases / Vitrines d'exposition

<small>Serie / Series / Série</small>	VEB & VEP	Expositor de barra y platos Bar display exhibitor case and plate / Vitrine à tapas	230 - 233
<small>Serie / Series / Série</small>	VET	Expositor de tapas y pintxos Bar display exhibitor case and plate / Vitrine à tapas	234 - 235
<small>Serie / Series / Série</small>	VSU	Expositor sushi, pescado y marisco Sushi, fish and seafood display case / Vitrine sushi, poisson et crustacés	236 - 237
<small>Serie / Series / Série</small>	VIP	Vitrina para pizza y sandwiches cuba 1/4 Refrigerated pizza & sandwiches cases 1/4 trays Vitrine ingrédients pizzas et sandwiches 1/4	238 - 239
		Vitrina para pizza y sandwiches cuba 1/3 Refrigerated pizza & sandwiches cases 1/3 trays Vitrine ingrédients pizzas et sandwiches 1/3	240 - 241
<small>Serie / Series / Série</small>	VMS	Vitrina mural sobre mostrador Wall display counter case / Vitrine murale	242 - 243
<small>Serie / Series / Série</small>	VC	Vitrina cerrada refrigerada 3/4 vision counter case / Vitrine réfrigérée comptoir panoramique	242 - 243
<small>Serie / Series / Série</small>	VRP	Vitrina expositora refrigerada carro para pescado Fish displays case / Vitrine réfrigérée pour poisson sur roulettes	244 - 245
<small>Serie / Series / Série</small>	VML MÁLAGA	Vitrina expositora para pescado Fish displays case / Vitrine réfrigérée pour poisson	244 - 245
<small>Serie / Series / Série</small>	VGR GRANADA	Vitrina expositora Displays case / Vitrine de présentation	246 - 247
<small>Serie / Series / Série</small>	VMB MARBELLA	Vitrina expositora frío ventilado Refrigerated with storage display case Vitrine de présentation avec réserve non canalizable	248 - 249 252 - 253
<small>Serie / Series / Série</small>	VMC MALLORCA	Vitrina expositora frío ventilado con reserva Refrigerated with storage display case Vitrine de présentation avec réserve non canalizable	250 - 251 252 - 253

+Info: www.infrico.com











Serie / Series / Série

VEB & VEP

							
VEP 4 P	VEP 6 P	VEP 8 P	VEB 4 CC	VEB 6 CC	VEB 7 CC	VEB 8 CC	VEB 9 CC
							
VEB 4 CP	VEB 6 CP	VEB 7 CP	VEB 8 CP	VEB 9 CP			

Serie / Series / Série

VET

									
VET 4 P	VET 6 P	VET 8 P	VET 4 DP	VET 6 DP	VET 8 DP	VET 7 P GR	VET 9 P GR	VET 7 DP GR	VET 9 DP GR

Serie / Series / Série

VSU

					
VSU 4 P	VSU 6 P	VSU 8 P	VSU 4 PR	VSU 6 PR	VSU 8 PR

Serie / Series / Série

VIP 1/4

					
CRISTAL / GLASS / VITRÉE	VIP 1330 1/4 C	VIP 1490 1/4 C	VIP 1740 1/4 C	VIP 1980 1/4 C	VIP 2300 1/4 C
					
TAPA / LID / COUVERCLE INOX	VIP 1330 1/4 T	VIP 1490 1/4 T	VIP 1740 1/4 T	VIP 1980 1/4 T	VIP 2300 1/4 T

VIP 1/3

					
CRISTAL / GLASS / VITRÉE	VIP 1330 1/3 C	VIP 1490 1/3 C	VIP 1740 1/3 C	VIP 1980 1/3 C	VIP 2300 1/3 C
					
TAPA / LID / COUVERCLE INOX	VIP 1330 1/3 T	VIP 1490 1/3 T	VIP 1740 1/3 T	VIP 1980 1/3 T	VIP 2300 1/3 T

Serie / Series / Série

VMS

		
VMS 1000 I	VMS 1350 I	VMS 1500 I

RESTYLING Serie / Series / Série

VC

	
VC 1400	VC 2010

Serie / Series / Série

VRP

VRP 13

Serie / Series / Série

VML MÁLAGA

		
VML 12	VML 15	VML 18

Serie / Series / Série

VGR GRANADA

											
VGR9	VGR12	VGR15	VGR18	VGR25	VGR28	VGR9 P	VGR12 P	VGR15 P	VGR18 P	VGR25 P	VGR28 P
CRISTAL CURVO / CURVED GLASS / VITRE BOMBÉE						CRISTAL RECTO / FLAT GLASS / VITRE DROITE					

Serie / Series / Série

VMB MARBELLA

														
VMB 9 RU	VMB 12 RU	VMB 15 RU	VMB 18 RU	VMB 25 RU	VMB 9 RIU	VMB 12 RIU	VMB 15 RIU	VMB 18 RIU	VMB 25 RIU	VMB 9 RUP	VMB 12 RUP	VMB 15 RUP	VMB 18 RUP	VMB 25 RUP
CRISTAL CURVO / CURVED GLASS / VITRE BOMBÉE					CRISTAL RECTO / FLAT GLASS / VITRE DROITE									

Serie / Series / Série

VMC MALLORCA

				
VMC 9 RU/RIU	VMC 12 RU/RIU	VMC 15 RU/RIU	VMC 18 RU/RIU	VMC 25 RU/RIU

Serie / Series / Série

VMB

		
VMB 9 C	VMB 12 M	VMB 15 M

Serie / Series / Série

VMC

		
VMC 9 C	VMC 12 M	VMC 15 M

Expositor de barra y platos / Bar display exhibitor case and plate / Vitrine à tapas

MODELO MODELE MODÈLE	VEP				VEB			
	VEP 4 P	VEP 6 P	VEP 8 P	VEB 4 CC	VEB 6 CC	VEB 7 CC	VEB 8 CC	VEB 9 CC
Precio Price Prix								
Medidas Measures Mesures (mm)	1268 x 410 x 230 mm.	1620 x 410 x 230 mm.	1972 x 410 x 230 mm.	810 x 415 x 195 mm.	1162 x 415 x 195 mm.	1338 x 415 x 195 mm.	1514 x 415 x 195 mm.	1690 x 415 x 195 mm.
Temperatura Temperature Température (°C)	-1°C/+7°C							
Clase Climática Climatic class Classe climatique (°C)	4 / 38°C							
Tensión/Frecuencia Electrical data Tension électrique	230V/1ph/50Hz							
Controlador Controller Régulateur	Digital							
Material Material Matériel (EXT/INT)	Aluminio anodizado / Anodized aluminium / Aluminium anodisé Inox AISI 304							
Espesor Thickness Épaisseur (mm)	70							
Aislamiento Isolation Isolation (mm)	40kg/m ³ / Free CFC's / Zero ODP-GWP							
Capacidad Capacity Capacité (L)	9,2	13,6	18,4	9,2	13,6	16,0	18,4	20,4
Superficie exposición Surface exhibition Surface d'exposition (m ²)	0,23	0,34	0,46	0,23	0,34	0,40	0,46	0,51
Nº puertas Doors Nº de portes	2			1				
Sistema de frío Cooling System Système de froid	Ventilado / Ventilated / Ventilé							
Desescarche Defrost Dégivrage	Manual / Manual / Manuel							
Expansión Expansion Expansion	Capilar / Capillary / Capillaire							
Potencia Power Puissance (W)	129	131	133	129	131	132	132	133
Potencia frig. Cooling capacity Puissance Frig. (W A -10°C)	169							
Consumo Consumption Consommation (kWh/ 24h)	1,93	1,96	1,99	1,93	1,95	1,97	1,98	2,00
Área refrigerada Refrigerated area Zone réfrigérée (m ²)	0,39	0,5	0,61	0,24	0,35	0,4	0,45	0,51
Refrigerante Refrigerant Gaz	R-600							
Opcional Optional Options	-							

Serie / Series / Série **VEP & VEB**

+Info: www.infrico.com

VEB 8 CC



Expositor encastrable
Drop-in exhibitor
Présentoir encastrable

VEP 6 P

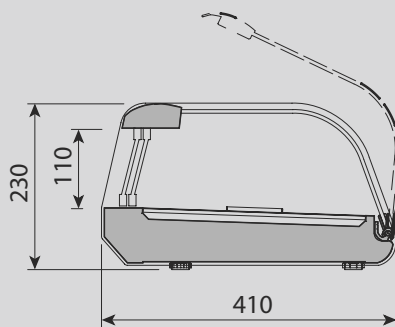



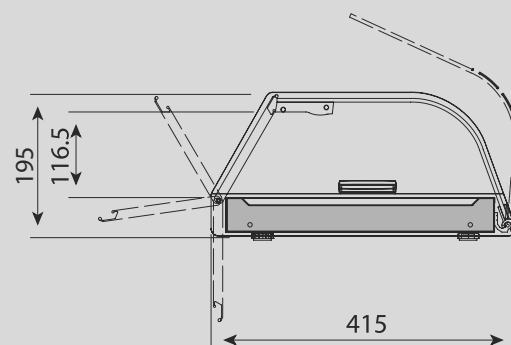

VEP P



VEB CC

Expositor de barra y platos / Bar display exhibitor case and plate / Vitrine à tapas

MODELO MODELE MODÈLE					
	VEB 4 CP	VEB 6 CP	VEB 7 CP	VEB 8 CP	VEB 9 CP
Precio Price Prix					
Medidas Measures [mm] Mesures	810 x 395 x 195 mm.	1162 x 395 x 195 mm.	1338 x 395 x 195 mm.	1514 x 395 x 195 mm.	1690 x 395 x 195 mm.
Temperatura Temperature [°C] Température	-1°C/+7°C				
Clase Climática Climatic class [°C] Classe climatique	4 / 38°C				
Tensión/Frecuencia Electrical data Tension électrique	230V/1ph/50Hz				
Controlador Controller Régulateur	Digital				
Material Material [EXT/INT] Matériel	Aluminio anodizado / Anodized aluminium / Aluminium anodisé Inox AISI 304				
Espesor Thickness [mm] Épaisseur	70				
Aislamiento Isolation [mm] Isolation	40kg/m ³ / Free CFC's / Zero ODP-GWP				
Capacidad Capacity [L] Capacité	9,2	13,6	16,0	18,4	20,4
Superficie exposición Surface exhibition [m ²] Surface d'exposition	0,23	0,34	0,40	0,46	0,51
Nº puertas Doors Nº de portes					
Sistema de frío Cooling System Système de froid	Ventilado / Ventilated / Ventilé				
Desescarche Defrost Dégivrage	Manual / Manual / Manuel				
Expansión Expansion Expansion	Capilar / Capillary / Capillaire				
Potencia Power [W] Puissance	129	131	132	132	133
Potencia fríg. Cooling capacity [W A -10°C] Puissance Frig.	169				
Consumo Consumption [kWh/ 24h] Consommation	1,93	1,95	1,97	1,98	2,00
Área refrigerada Refrigerated area [m ²] Zone réfrigérée	0,24	0,35	0,4	0,45	0,51
Refrigerante Refrigerant Gaz	R-600				
Opcional Optional Options	-				

Serie / Series / Série **VEP & VEB**

+Info: www.infrico.com

VEB 6 CP



Expositor encastrable
Drop-in exhibitor
Présentoir encastrable



VEB 6 CP



VEB 4 CP

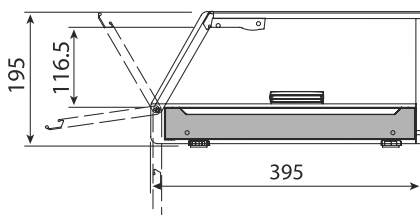

Expositor de tapas y pintxos / Bar display exhibitor case and plate / Vitrine à tapas

MODELO MODELE MODÈLE										
	VET 4 P	VET 6 P	VET 8 P	VET 4 DP	VET 6 DP	VET 8 DP	VET 7 P GR	VET 9 P GR	VET 7 DP GR	VET 9 DP GR
Precio Price Prix										
Medidas Measures Mesures (mm)	1268 x 410 x 230 mm.	1620 x 410 x 230 mm.	1972 x 410 x 230 mm.	1268 x 412 x 330 mm.	1620 x 412 x 330 mm.	1972 x 412 x 330 mm.	1338 x 410 x 230 mm.	1690 x 410 x 230 mm.	1338 x 412 x 330 mm.	1690 x 412 x 330 mm.
Temperatura Temperature Température (°C)	-1°C/+7°C									
Clase Climática Climatic class Classe climatique (°C)	4 / 38°C									
Tensión/Frecuencia Electrical data Tension électrique	230V/1ph/50Hz									
Controlador Controller Régulateur	Digital									
Material Material Matériel (EXT/INT)	Aluminio anodizado / Anodized aluminium / Aluminium anodisé Inox AISI 304									
Espesor Thickness Épaisseur (mm)	70									
Aislamiento Isolation Isolation (mm)	40kg/m ³ / Free CFC's / Zero ODP-GWP									
Capacidad Capacity Capacité (L)	9,2	13,6	18,4	9,2	13,6	18,4	16,0	20,4	16,0	20,4
Superficie exposición Surface exhibition Surface d'exposition (m ²)	0,23	0,34	0,46	0,23	0,34	0,46	0,40	0,51	0,40	0,51
Bandejas GN Trays GN Grilles GN	4	6	8	4	6	8	7	9	7	9
Sistema de frío Cooling System Système de froid	Ventilado / Ventilated / Ventilé									
Desescarche Defrost Dégivrage	Manual / Manual / Manuel									
Expansión Expansion Expansion	Capilar / Capillary / Capillaire									
Potencia Power Puissance (W)	129	131	133	133	136	140	131	133	131	133
Potencia frig. Cooling capacity Puissance Frig. (W A -10°C)	169									
Consumo Consumption Consommation (kWh/ 24h)	1,79	1,82	1,84	1,85	1,90	1,96	1,83	1,83	1,86	1,86
Área refrigerada Refrigerated area Zone réfrigérée (m ²)	0,41	0,52	0,63	0,72	0,92	1,12	0,43	0,54	0,76	0,96
Refrigerante Refrigerant Gaz	R-600a									
Opcional Optional Options	-									

Serie / Series / Série **VET**

+Info: www.infrico.com

VET 8 P



VET 6 DP



Expositor encastrable
Drop-in exhibitor
Présentoir encastrable

VET 7 DP GR

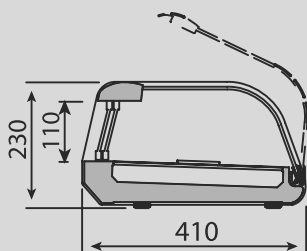

VET P

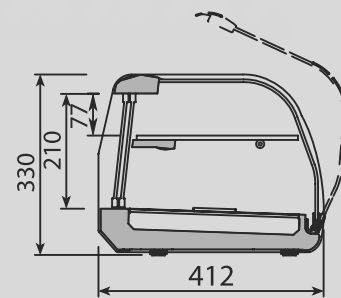

VET DP / DP GR

Expositor sushi, pescado y marisco / Sushi, fish and seafood display case / Vitrine sushi, poisson et crustacés

MODELO MODELE MODÈLE						
	VSU 4 P	VSU 6 P	VSU 8 P	VSU 4 PR	VSU 6 PR	VSU 8 PR
Precio Price Prix						
Medidas Measures Mesures (mm)	1268 x 410 x 230 mm.	1620 x 410 x 230 mm.	1972 x 410 x 230 mm.	1268 x 410 x 230 mm.	1620 x 410 x 230 mm.	1972 x 410 x 230 mm.
Temperatura Temperature Température (°C)	-1°C/+7°C					
Clase Climática Climatic class Classe climatique (°C)	3 / 25°C					
Tensión/Frecuencia Electrical data Tension électrique	230V/1ph/50Hz					
Controlador Controller Régulateur	Digital					
Material Material Matériel (EXT/INT)	Aluminio anodizado / Anodized aluminium / Aluminium anodisé Inox AISI 304					
Espesor Thickness Épaisseur (mm)	70					
Aislamiento Isolation Isolation (mm)	40kg/m ³ / Free CFC's / Zero ODP-GWP					
Capacidad Capacity Capacité (L)	9,2	13,3	15,5	9,2	13,3	15,5
Superficie exposición Surface exhibition Surface d'exposition (m ²)	0,23	0,34	0,46	0,23	0,34	0,46
Nº puertas Doors Nº de portes	2					
Sistema de frío Cooling System Système de froid	Ventilado / Ventilated / Ventilé					
Desescarche Defrost Dégivrage	Manual / Manual / Manuel					
Expansión Expansion Expansion	Capilar / Capillary / Capillaire					
Potencia Power Puissance (W)	225	227	228	225	227	228
Potencia frig. Cooling capacity Puissance Frig. (W A -10°C)	370					
Consumo Consumption Consommation (kWh/ 24h)	4,81	4,83	4,85	4,81	4,83	4,85
Área refrigerada Refrigerated area Zone réfrigérée (m ²)	0,23	0,34	0,46	0,23	0,34	0,46
Refrigerante Refrigerant Gaz	R-290a					
Opcional Optional Options	-					

Serie / Series / Série **VSU**

+Info: www.infrico.com

VSU 8 P



VSU 8 PR

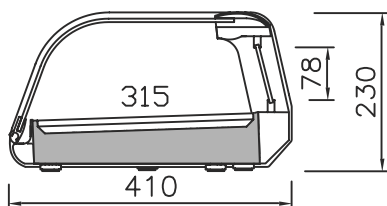









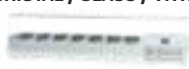

VSU P / PR

Desagüe en la parte inferior
Bottom drain
Drainage au fond



Vitrina para pizza y sandwiches, cuba 1/4 / Refrigerated pizzas & sandwiches cases, 1/4 trays / Vitrine ingrédients pizzas & sandwiches 1/4

MODELO MODELE MODÈLE					
	VIP 1330 1/4 C	VIP 1490 1/4 C	VIP 1740 1/4 C	VIP 1980 1/4 C	VIP 2300 1/4 C
Precio Price Prix					
Medidas Measures Mesures (mm)	1328 x 353 x 450 mm.	1493 x 353 x 450 mm.	1733 x 353 x 450 mm.	1976 x 353 x 450 mm.	2300 x 353 x 450 mm.
MODELO MODELE MODÈLE					
	VIP 1330 1/4 T	VIP 1490 1/4 T	VIP 1740 1/4 T	VIP 1980 1/4 T	VIP 2300 1/4 T
Precio Price Prix					
Medidas Measures Mesures (mm)	1328 x 353 x 260 mm.	1493 x 353 x 260 mm.	1733 x 353 x 260 mm.	1976 x 353 x 260 mm.	2300 x 353 x 260 mm.
Temperatura Temperature Température (°C)	-1°C/+7°C				
Clase Climática Climatic class Classe climatique (°C)	4 / 38°C				
Tensión/Frecuencia Electrical data Tension électrique	230V/1ph/50Hz				
Controlador Controller Régulateur	Digital				
Material Material (EXT/INT) Matériel	Inox AISI 304				
Espesor Thickness Épaisseur (mm)	70				
Aislamiento Isolation Isolation (mm)	40kg/m ³ / Free CFC's / Zero ODP-GWP				
Capacidad Capacity Capacité (L)	32	37	48	57	70
Superficie exposición Surface exhibition Surface d'exposition (m ²)	0,20	0,24	0,31	0,37	0,45
Compresor Compressor Compresseur (HP)	-				
Sistema de frío Cooling System Système de froid	Ventilado / Ventilated / Ventilé				
Desescarche Defrost Dégivrage	Manual / Manual / Manuel				
Expansión Expansion Expansion	Capilar / Capillary / Capillaire				
Potencia Power Puissance (W)	125				
Potencia frig. Cooling capacity Puissance Frig. (W A -10°C)	169				
Consumo Consumption Consommation (kWh/ 24h)	1,33	1,36	1,39	1,41	1,44
Refrigerante Refrigerant Gaz	R-600a				
Opcional Optional Options	Puertas correderas traseras MOD. C / Rear sliding doors MOD. C / Portes coulissantes arrière MOD. C				
	KPUVIP134C	KPUVIP144C	KPUVIP174C	KPUVIP194C	KPUVIP234C

Serie / Series / Série **VIP**

+Info: www.infrico.com

VIP 2300 1/4 T
TAPA / LID / COUVERCLE INOX

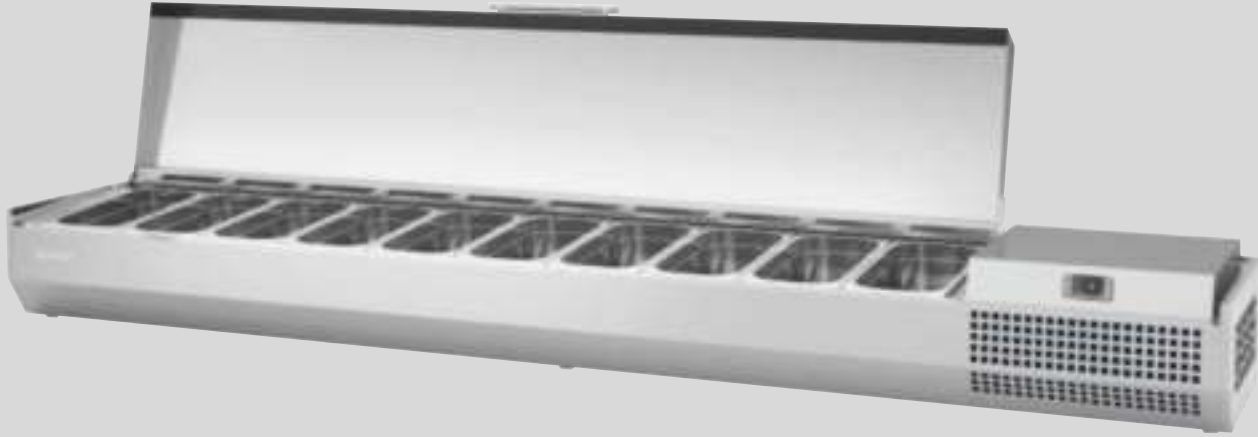

VIP 2300 1/4 C
CRISTAL / GLASS / VITRÉE



Puertas correderas traseras
Rear sliding doors
Portes coulissantes arrière

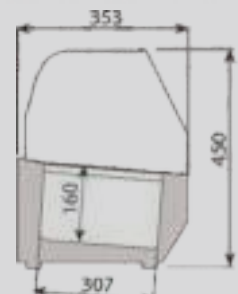

VIP 1/4 C
CRISTAL / GLASS / VITRÉE

VIP 1330 1/4
{501X13} = 1 {501X16} = 3



VIP 1490 1/4
{501X16} = 6



VIP 1740 1/4
{501X13} = 1 {501X16} = 5



VIP 1/4 T
TAPA / LID / COUVERCLE INOX

VIP 1980 1/4
{501X13} = 1

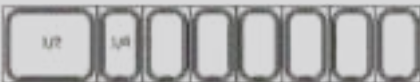

VIP 2300 1/4
{501X13} = 1 {501X16} = 9



Vitrina para pizza y sandwiches, cuba 1/3 / Refrigerated pizza & sandwiches cases, 1/3 trays / Vitrine ingrédients pizza & sandwiches 1/3

MODELO MODELE MODÈLE	CRISTAL / GLASS / VITRÉE									
	VIP 1330 1/3 C	VIP 1490 1/3 C	VIP 1740 1/3 C	VIP 1980 1/3 C	VIP 2300 1/3 C					
Precio Price Prix										
Medidas Measures Mesures (mm)	1328 x 413 x 450 mm.	1493 x 413 x 450 mm.	1733 x 413 x 450 mm.	1976 x 413 x 450 mm.	2300 x 413 x 450 mm.					
MODELO MODELE MODÈLE	TAPA / LID / COUVERCLE INOX									
	VIP 1330 1/3 T	VIP 1490 1/3 T	VIP 1740 1/3 T	VIP 1980 1/3 T	VIP 2300 1/3 T					
Precio Price Prix										
Medidas Measures Mesures (mm)	1328 x 413 x 260 mm.	1493 x 413 x 260 mm.	1733 x 413 x 260 mm.	1976 x 413 x 260 mm.	2300 x 413 x 260 mm.					
Temperatura Temperature Température (°C)	-1°C/+7°C									
Clase Climática Climatic class Classe climatique (°C)	4 / 38°C									
Tensión/Frecuencia Electrical data Tension électrique	230V/1ph/50Hz									
Controlador Controller Régulateur	Digital									
Material Material (EXT/INT) Matériel	Inox AISI 304									
Espesor Thickness Épaisseur (mm)	70									
Aislamiento Isolation Isolation (mm)	40kg/m ³ / Free CFC's / Zero ODP-GWP									
Capacidad Capacity Capacité (L)	CRISTAL / GLASS / VITRÉE TAPA / LID / COUVERCLE	41 32	CRISTAL / GLASS / VITRÉE TAPA / LID / COUVERCLE	50 37	CRISTAL / GLASS / VITRÉE TAPA / LID / COUVERCLE	64 48	CRISTAL / GLASS / VITRÉE TAPA / LID / COUVERCLE	78 57	CRISTAL / GLASS / VITRÉE TAPA / LID / COUVERCLE	97 70
Superficie exposición Surface exhibition Surface d'exposition (m ²)	CRISTAL / GLASS / VITRÉE TAPA / LID / COUVERCLE	0,26 0,20	CRISTAL / GLASS / VITRÉE TAPA / LID / COUVERCLE	0,31 0,24	CRISTAL / GLASS / VITRÉE TAPA / LID / COUVERCLE	0,39 0,31	CRISTAL / GLASS / VITRÉE TAPA / LID / COUVERCLE	0,46 0,37	CRISTAL / GLASS / VITRÉE TAPA / LID / COUVERCLE	0,57 0,45
Compresor Compressor Compresseur (HP)	-									
Sistema de frío Cooling System Système de froid	Ventilado / Ventilated / Ventilé									
Desescarche Defrost Dégivrage	Manual / Manual / Manuel									
Expansión Expansion Expansion	Capilar / Capillary / Capillaire									
Potencia Power Puissance (W)	125									
Potencia frig. Cooling capacity Puissance Frig. (W A -10°C)	169									
Consumo Consumption Consommation (kWh/ 24h)	1,35	1,37	1,40	1,43	1,45					
Refrigerante Refrigerant Gaz	R-600a									
Opcional Optional Options	Puertas correderas traseras MOD. C / Rear sliding doors MOD. C / Portes coulissantes arrière MOD. C									
	KPUVIP133C	KPUVIP143C	KPUVIP173C	KPUVIP193C	KPUVIP233C					

Serie / Series / Série **VIP**

+Info: www.infrico.com

VIP 2300 1/3 T
TAPA / LID / COUVERCLE INOX



VIP 2300 1/3 C
CRISTAL / GLASS / VITRÉE



Opcion/Option/Option
Puertas correderas traseras
Rear sliding doors
Portes coulissantes arrière

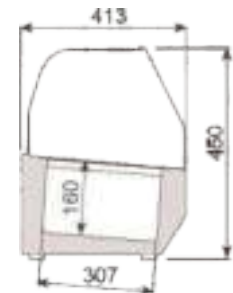

VIP 1/3 C
CRISTAL / GLASS / VITRÉE

VIP 1330 1/3
(501X13) = 1 (501X11) = 3



VIP 1490 1/3
(501X13) = 1 (501X11) = 4



VIP 1740 1/3
(501X13) = 1 (501X11) = 5



VIP 1980 1/3
(501X11) = 8



VIP 2300 1/3
(501X11) = 10

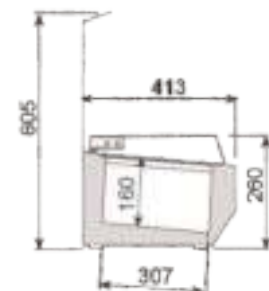

VIP 1/3 T
TAPA / LID / COUVERCLE INOX

Vitrina mural sobre mostrador / Wall display counter case / Vitrine murale

Vitrina cerrada refrigerada / 3/4 vision counter case / Vitrine réfrigérée comptoir panoramique

MODELO MODELE MODÈLE	VMS 1000 I	VMS 1350 I	VMS 1500 I	VC 1400	VC 2010
Precio Price Prix					
Medidas Measures Mesures (mm)	1003 x 580 x 1110 mm.	1354 x 580 x 1110 mm.	1504 x 580 x 1110 mm.	1384 x 740 x 1060 mm.	2011 x 740 x 1060 mm.
Temperatura Temperature Température (°C)	3°C/+6°C				
Clase Climática Climatic class Classe climatique (°C)	4 / 38°C			4 / 38°C	
Tensión/Frecuencia Electrical data Tension électrique	230V/1ph/50Hz				
Controlador Controller Régulateur	Digital				
Material Material Matériel (EXT/INT)	Inox AISI 304				
Espesor Thickness Épaisseur (mm)	70				
Aislamiento Isolation Isolation (mm)	40kg/m ³ / Free CFC's / Zero ODP-GWP				
Capacidad Capacity Capacité (L)	220	300	340	470	710
Superficie exposición Surface exhibition Surface d'exposition (m ²)	0,36	0,50	0,56		
Nº puertas / Estantes Doors / Shelving Nº de portes / Étagères	2 / 2			2 / 2	3 / 2
Sistema de frío Cooling System Système de froid	Ventilado / Ventilated / Ventilé			Ventilado / Ventilated / Ventilé	
Desescarche Defrost Dégivrage	Automático / Automatic / Automatique			Parada de compresor / Compressor off / Arrêt du compresseur	
Expansión Expansion Expansion	Capilar / Capillary / Capillaire			Capilar / Capillary / Capillaire	
Potencia Power Puissance (W)	239	246	249	551	557
Potencia frig. Cooling capacity Puissance Frig. (W A -10°C)	-			687	
Consumo Consumption Consommation (kWh/ 24h)	3,4	3,54	3,6	8,6	9,7
Clase energética Energy class Classe Énerg.					
Refrigerante Refrigerant Gaz	R-290				
Opcional Optional Options	-			Puerta de cristal Glass door (unit) Porte vitrée (unité) (Dcha.-Right-Droite) KPUIDVCCR (Izq.-Left-Gauche) KPUIVCCR Estante de cristal Glass shelf (unit) Étagère vitrée (unité) [604V156] Cerradura puerta ciega Solid door lock Serrure porte inox [506X120; 506X121] Cerradura puerta cristal Glass door lock Serrure porte vitrée [506X60] Opción color NEGRO Option BLACK color Couleur NOIR en option  VC 1400 B VC 2010 B	

RESTYLING

Series / Série **VMS / VC**

+Info: www.infrico.com

VC 2010



VMS 1000 I



VC 1400



**Puertas traseras /
Back doors /
Portes arrières**





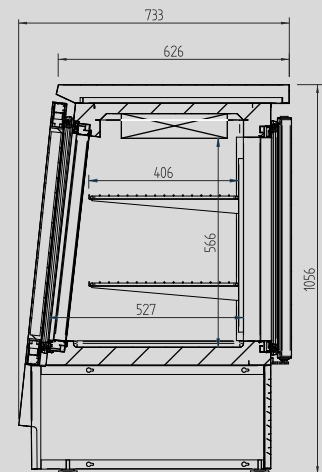

VC 2100



Vitrina expositora carro para pescado /
Fish display case /
Vitrine réfrigérée pour poisson sur roulettes

Vitrina expositora para pescado /
Fish display case /
Vitrine réfrigérée pour poisson

MODELO MODELE MODÈLE	VRP 	VML 12 	VML 15 	VML 18 
Precio Price Prix				
Medidas Measures Mesures (mm)	1320 x 850 x 1275 mm.	1330 x 900 x 1335 mm.	1642 x 900 x 1335 mm.	1955 x 900 x 1335 mm.
Temperatura Temperature Température (°C)	-1°C/+1°C			
Clase Climática Climatic class Classe climatique (°C)	4 / 38°C			
Tensión/Frecuencia Electrical data Tension électrique	230V/1ph/50Hz			
Controlador Controller Régulateur	Digital			
Material Material Matériel (EXT/INT)	Inox AISI 304			
Espesor Thickness Épaisseur (mm)	70			
Aislamiento Isolation Isolation (mm)	40kg/m ³ / Free CFC's / Zero ODP-GWP			
Capacidad Capacity Capacité (L)	115	115	237	360
Superficie exposición Surface exhibition Surface d'exposition (m ²)	0,75	0,79	0,99	1,19
Compresor Compressor Compresseur (HP)	1/4	1/3	1/2	7/8
Sistema de frío Cooling System Système de froid	Ventilado / Ventilated / Ventilé			
Desescarche Defrost Dégivrage	Manual / Manual / Manuel			
Expansión Expansion Expansion	Capilar / Capillary / Capillaire			
Potencia Power Puissance (W)	475	410	410	520
Potencia frig. Cooling capacity Puissance Frig. (W A -10°C)	-			
Consumo Consumption Consumation (kWh/ 24h)	6,7	8,7	12,5	8,9
Clase energética Energy class Classe Énerg.				
Refrigerante Refrigerant Gaz	R-290a			
Opcional Optional Options		Iluminación LED frontal Frontal LED lighting Éclairage LED frontale ILUDECVMBC12	Iluminación LED frontal Frontal LED lighting Éclairage LED frontale ILUDECVMBC15	Iluminación LED frontal Frontal LED lighting Éclairage LED frontale ILUDECVMBC18

Serie / Series / Série **VRP / VML MÁLAGA**

+Info: www.infrico.com

VRP 13



VML 18

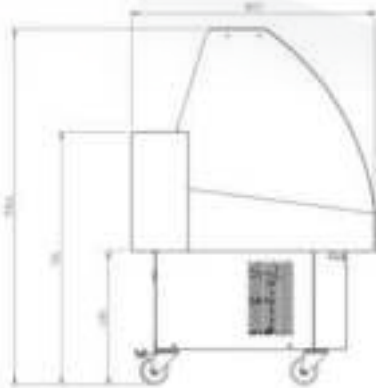



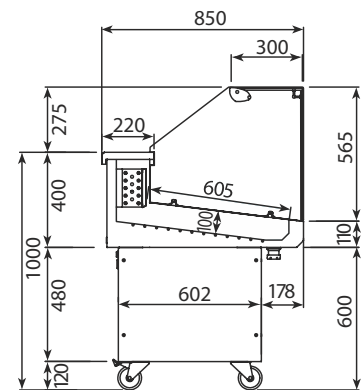









VML



VRP

Vitrina expositora / Display case / Vitrine de présentation non canalisable

MODELO MODELE MODÈLE						
	CRISTAL CURVO / CURVED GLASS / VITRE BOMBÉE					
Precio Price Prix						
Medidas Measures Mesures (mm)	998 x 993 x 1280 mm.	1310 x 993 x 1280 mm.	1622 x 993 x 1280 mm.	1935 x 993 x 1280 mm.	2560 x 993 x 1280 mm.	2872 x 993 x 1280 mm.
	CRISTAL RECTO / FLAT GLASS / VITRE DROITE					
MODELO MODELE MODÈLE						
Precio Price Prix						
Medidas Measures Mesures (mm)	998 x 993 x 1280 mm.	1310 x 993 x 1280 mm.	1622 x 993 x 1280 mm.	1935 x 993 x 1280 mm.	2560 x 993 x 1280 mm.	2872 x 993 x 1280 mm.
Temperatura Temperature Température (°C)	2°C/+6°C					
Clase Climática Climatic class Classe climatique (°C)	4 / 38°C					
Tensión/Frecuencia Electrical data Tension électrique	230V/1ph/50Hz					
Controlador Controller Régulateur	Digital					
Material Material (EXT/INT) Matériel	Acero plastificado / Plastic-coated steel / Acier plastifié Inox AISI 304					
Espesor Thickness Épaisseur (mm)	70					
Aislamiento Isolation Isolation (mm)	40kg/m ³ / Free CFC's / Zero ODP-GWP					
Capacidad Capacity Capacité (L)	200	262	324	387	512	574
Superficie exposición Surface exhibition Surface d'exposition (m ²)	0,6	0,8	1,0	1,1	1,5	1,7
Sistema de frío Cooling System Système de froid	Ventilado / Ventilated / Ventilé					
Desescarche Defrost Dégivrage	Manual / Manual / Manuel					
Expansión Expansion Expansion	Capilar / Capillary / Capillaire					
Potencia Power Puissance (W)	282		451		653	
Potencia frig. Cooling capacity Puissance Frig. (W A -10°C)	370		687		951	
Consumo Consumption Consommation (kWh/ 24h)	-					
Clase energética Energy class Classe Énerg.	-					
Refrigerante Refrigerant Gaz	R-290a					
Opcional Optional Options	Puertas correderas traseras / Rear sliding doors / Portes coulissantes arrière			Estante iluminado / Lighting shelf / Étagère et éclairage		
	KPUVGR9C	KPUVGR12C	KPUVGR15C	KPUVGR18C	KPUVGR25C	KPUVGR28C
	KPUVGR9P	KPUVGR12P	KPUVGR15P	KPUVGR18P	KPUVGR25P	KPUVGR28P
					ESTMEDGR9	ESTMEDGR25
					ESTMEDGR12	ESTMEDGR25P
					ESTMEDGR15	ESTMEDGR28
					ESTMEDGR18	ESTMEDGR28P

La vitrina se suministra con los cristales y decoración desmontada
Display case provides with glasses and disassembled decoration
La vitrine est livrée avec les parties vitrées et la décoration démontées.

Serie / Series / Série **GRANADA**

+Info: www.infrico.com

VGR 18



Ext. Estándar / Standar / Standard

Blanco/White/ Blanc	Ral 1001	Ral 1018
Ral 3003	Ral 3020	Ral 2003
Ral 5015	Ral 5017	Ral 5011
Ral 6002	Ral 6018	Ral 6019
Ral 7035	Ral 7037	Ral 7042
Ral 7016	Ral 9006	Negro/Black/ Noir

**Colores fuera de carta /
Colors outside of letter /
Couleurs spéciales, hors palette**

RAL		NO RAL	
Epoxi	Líquida/ Liquid/ Liquide	Epoxi	Líquida/ Liquid/ Liquide
[x unidad/x unit/x unité]		Consultar / Consulter / Consulter	
+10 días laborables / +10 work days / +10 jours ouvrés		Consultar / Consulter / Consulter	

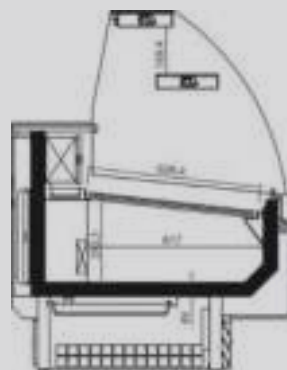



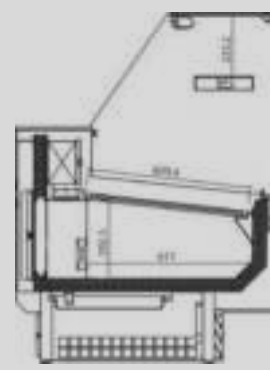







VGR



VGR P

Vitrina expositora frío ventilado / Refrigerated whit storage display case / Vitrine de présentation non canalisable

		CRISTAL CURVO / CURVED GLASS / VITRE BOMBÉE				
MODELO MODELE MODÈLE		 VMB 9 RU/RIU	 VMB 12 RU/RIU	 VMB 15 RU/RIU	 VMB 18 RU/RIU	 VMB 25 RU/RIU
Precio Price Prix	RU RIU					
Medidas Measures Mesures	(mm)	998 x 953 x 1300 mm.	1310 x 953 x 1300 mm.	1622 x 953 x 1300 mm.	1935 x 953 x 1300 mm.	2560 x 953 x 1300 mm.
MODELO MODELE MODÈLE		CRISTAL RECTO / FLAT GLASS / VITRE DROITE				
		 VMB 9 RUP/RIUP	 VMB 12 RUP/RIUP	 VMB 15 RUP/RIUP	 VMB 18 RUP/RIUP	 VMB 25 RUP/RIUP
Precio Price Prix	RUP RIUP					
Medidas Measures Mesures	(mm)	998 x 953 x 1315 mm.	1310 x 953 x 1315 mm.	1622 x 953 x 1315 mm.	1935 x 953 x 1315 mm.	2560 x 953 x 1315 mm.
Temperatura Temperature Température	(°C)	0°C/+6°C				
Clase Climática Climatic class Classe climatique	(°C)	4 / 38°C				
Tensión/Frecuencia Electrical data Tension électrique		230V/1ph/50Hz				
Controlador Controller Régulateur		Digital				
Material Material Matériel	(EXT/INT)	Acero plastificado / Plastic-coated steel / Acier plastifié Inox AISI 304				
Costados Sides Joues	(mm)	30 + 30				
Aislamiento Isolation Isolation	(mm)	40kg/m ³ / Free CFC's / Zero ODP-GWP				
Capacidad Capacity Capacité	(L)	144	191	239	287	382
Superficie exposición Surface exhibition Surface d'exposition	(m ²)	0,66	1,08	1,35	1,63	2,18
Compresor Compressor Compresseur	(HP)	1/3	3/8	5/8	3/4	1
Sistema de frío Cooling System Système de froid		Ventilado / Ventilated / Ventilé				
Desescarche Defrost Dégivrage		Automático / Automatic / Automatique				
Expansión Expansion Expansion		Ventilado / Ventilated / Ventilé				
Potencia Power Puissance	(W)	380	384	523	573	670
Potencia frig. Cooling capacity Puissance Frig.	(W A -10°C)	-				
Consumo Consumption Consommation	(kWh/ 24h)	5,9	6,1	7,6	8,3	9,7
Refrigerante Refrigerant Gaz		R-290a				
Opcional Optional Options		Puertas correderas traseras / Rear sliding doors / Portes coulissantes arrière VMB PUEVMB9CT PUEVMB12CT PUEVMB15CT PUEVMB18CT PUEVMB25CT		VMB P PUEVMB9CTCP PUEVMB12CTCP PUEVMB15CTCP PUEVMB18CTCP PUEVMB25CTCP		Luz LED deco. frontal / Frontal deco. LED lighting / Éclair. LED deco. frontale ILUDECVMBC9 ILUDECVMBC12 ILUDECVMBC15 Luz LED estante / LED lighting shelf / Éclairage LED étagère ILUESTVMBC9 ILUESTVMBC12 ILUESTVMBC15

Serie / Series / Série **MARBELLA**

+Info: www.infrico.com

VMB 15 RU

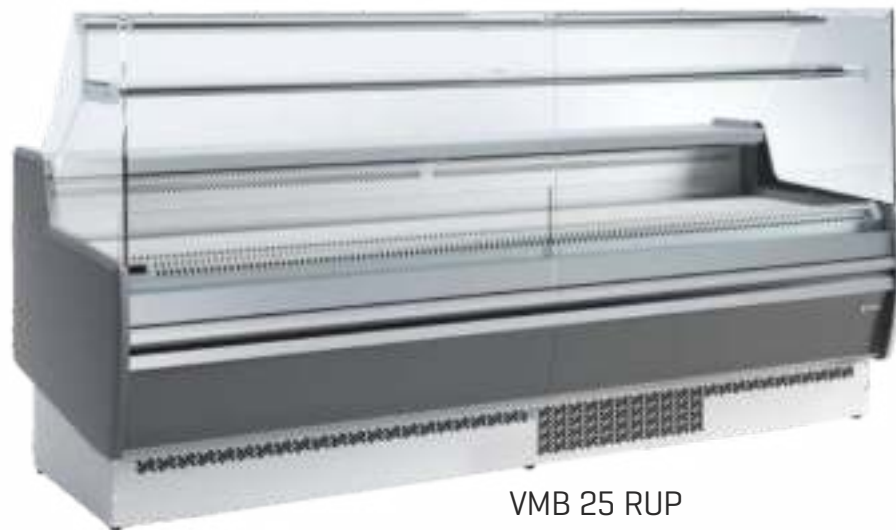

Ext. Estándar / Standar / Standard

Blanco/White/ Blanc	Ral 1001	Ral 1018
Ral 3003	Ral 3020	Ral 2003
Ral 5015	Ral 5017	Ral 5011
Ral 6002	Ral 6018	Ral 6019
Ral 7035	Ral 7037	Ral 7042
Ral 7016	Ral 9006	Negro/Black/ Noir

Colores fuera de carta /
Colors outside of letter /
Couleurs spéciales, hors palette

RAL		NO RAL	
Epoxi	Líquida/ Liquid/ Liquide	Epoxi	Líquida/ Liquid/ Liquide
[x unidad/x unit/x unité]		Consultar / Consultar / Consultar	
+10 días laborables / +10 work days / +10 jours ouvrés		Consultar / Consultar / Consultar	



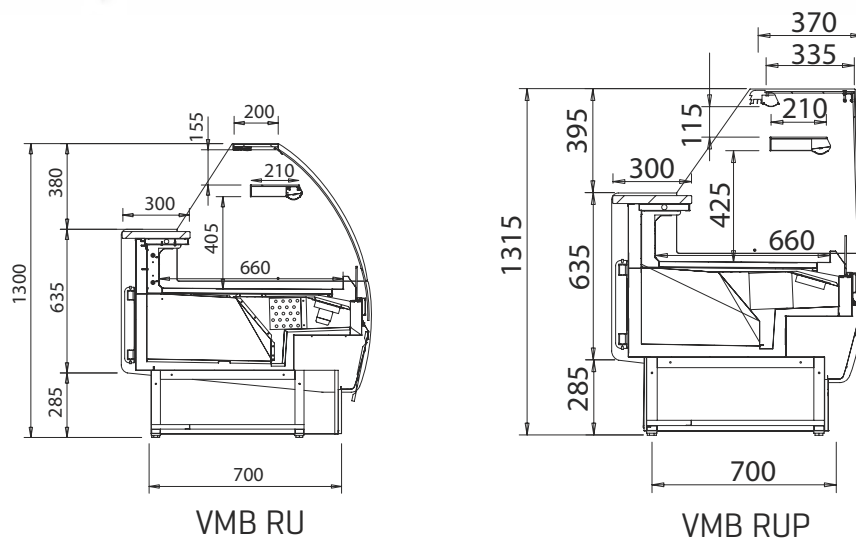

VMB 25 RUP



VMB RU

VMB RUP

Vitrina expositora frío ventilado con reserva / Refrigerated whit storage display case / Vitrine de présentation avec réserve non canalisable

MODELO MODELE MODÈLE						
	VMC 9 RU/RIU	VMC 12 RU/RIU	VMC 15 RU/RIU	VMC 18 RU/RIU	VMC 25 RU/RIU	
Precio Price Prix	RU					
	RIU					
Medidas Measures Mesures	(mm)	998 x 1103 x 1300 mm.	1310 x 1103 x 1300 mm.	1622 x 1103 x 1300 mm.	1935 x 1103 x 1300 mm.	2560 x 1103 x 1300 mm.
Temperatura Temperature Température	(°C)	0°C/+6°C				
Clase Climática Climatic class Classe climatique	(°C)	4 / 38°C				
Tensión/Frecuencia Electrical data Tension électrique		230V/1ph/50Hz				
Controlador Controller Régulateur		Digital				
Material Material Matériel	[EXT/INT]	Acero plastificado / Plastic-coated steel / Acier plastifié Inox AISI 304				
Costados Sides Joues	(mm)	30 + 30				
Aislamiento Isolation Isolation	(mm)	40kg/m ³ / Free CFC's / Zero ODP-GWP				
Capacidad Capacity Capacité	[L]	205	274	342	411	548
Superficie exposición Surface exhibition Surface d'exposition	(m ²)	0,82	1,09	1,36	1,63	2,18
Compresor Compressor Compresseur	[HP]	1/3	3/8	5/8	3/4	1
Sistema de frío Cooling System Système de froid		Ventilado / Ventilated / Ventilé				
Desescarche Defrost Dégivrage		Automático / Automatic / Automatique				
Expansión Expansion Expansion		Ventilado / Ventilated / Ventilé				
Potencia Power Puissance	[W]	380	384	523	573	670
Potencia fríg. Cooling capacity Puissance Frig.	[W A -10°C]			-		
Consumo Consumption Consommation	[kWh/ 24h]	5,9	6,1	7,6	8,3	9,7
Clase energética Energy class Classe Énerg.		-				
Refrigerante Refrigerant Gaz		R-290a				
Opcional Optional Options		Puertas correderas traseras / Rear sliding doors / Portes coulissantes arrière PUEVMC9CT PUEVMC12CT PUEVMC15CT PUEVMC18CT PUEVMC25CT		Luz LED deco. frontal / Frontal deco. LED lighting / Éclair. LED deco. frontale ILUDECVMBC9 ILUDECVMBC12 ILUDECVMBC15 Luz LED estante / LED lighting shelf / Éclairage LED étagère ILUESTVMBC9 ILUESTVMBC12 ILUESTVMBC15 ILUDECVMBC18 ILUDECVMBC25 ILUESTVMBC18 ILUESTVMBC25		

Serie / Series / Série **MALLORCA**

+Info: www.infrico.com

VMC 18 RU



VMC 12 RU



Ext. Estándar / Standar / Standard

Blanco/White/ Blanc	Ral 1001	Ral 1018
Ral 3003	Ral 3020	Ral 2003
Ral 5015	Ral 5017	Ral 5011
Ral 6002	Ral 6018	Ral 6019
Ral 7035	Ral 7037	Ral 7042
Ral 7016	Ral 9006	Negro/Black/ Noir

**Colores fuera de carta /
Colors outside of letter /
Couleurs spéciales, hors palette**

RAL		NO RAL	
Epoxi	Líquida/ Liquid/ Liquide	Epoxi	Líquida/ Liquid/ Liquide
[x unidad/x unit/x unité]		Consultar / Consultar / Consulter	
+10 días laborables / +10 work days / +10 jours ouvrés		Consultar / Consultar / Consulter	

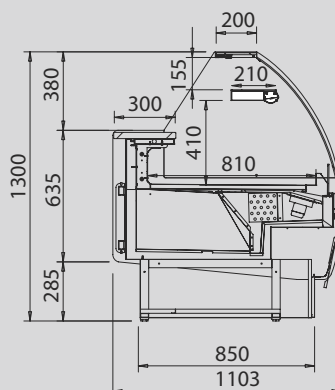

VMC RU

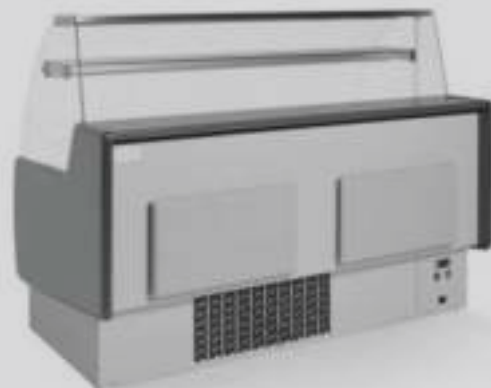

Mueble caja mostrador / Counter case / Meuble caisse



VMB 9 C



VMB 12 M



VMB 15 M

MODELO MODELE MODÈLE	VMB 9 C	VMB 12 M	VMB 15 M
Precio Price Prix			
Medidas Measures Mesures [mm]	998 x 953 x 920 mm.	1310 x 953 x 920 mm.	1622 x 953 x 920 mm.
Temperatura Temperature Température [°C]	-		
Clase Climática Climatic class Classe climatique [°C]	-		
Tensión/Frecuencia Electrical data Tension électrique	230V/1ph/50Hz		
Superficie exposición Surface exhibition Surface d'exposition [m ²]	0,62	0,83	1,03
Potencia Power Puissance [W]	-		

Mueble caja mostrador / Counter case / Meuble caisse

Serie / Series / Série MALLORCA



VMC 9 C



VMC 12 M

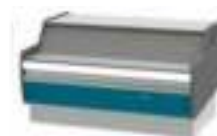

VMC 15 M

MODELO MODELE MODÈLE	VMC 9 C	VMC 12 M	VMC 15 M
Precio Price Prix			
Medidas Measures Mesures [mm]	998 x 1103 x 920 mm.	1310 x 1103 x 920 mm.	1622 x 1103 x 920 mm.
Temperatura Temperature Température [°C]	-		
Clase Climática Climatic class Classe climatique [°C]	-		
Tensión/Frecuencia Electrical data Tension électrique	230V/1ph/50Hz		
Superficie exposición Surface exhibition Surface d'exposition [m ²]	0,55	0,74	0,94
Potencia Power Puissance [W]	-		

Serie / Series / Série **MARBELLA**

+Info: www.infrico.com

VMB 9 C



VMB 12 C



VMC 12 M



VMC 15 M

Ext. Estándar / Standar / Standard

Blanco/White/ Blanc	Ral 1001	Ral 1018
Ral 3003	Ral 3020	Ral 2003
Ral 5015	Ral 5017	Ral 5011
Ral 6002	Ral 6018	Ral 6019
Ral 7035	Ral 7037	Ral 7042
Ral 7016	Ral 9006	Negro/Black/ Noir

**Colores fuera de carta /
Colors outside of letter /
Couleurs spéciales, hors palette**

RAL		NO RAL	
Epoxi	Líquida/ Liquid/ Liquide	Epoxi	Líquida/ Liquid/ Liquide
[x unidad/x unit/x unité]		Consultar / Consulter / Consulter	
+10 días laborables / +10 work days / +10 jours ouvrés		Consultar / Consulter / Consulter	

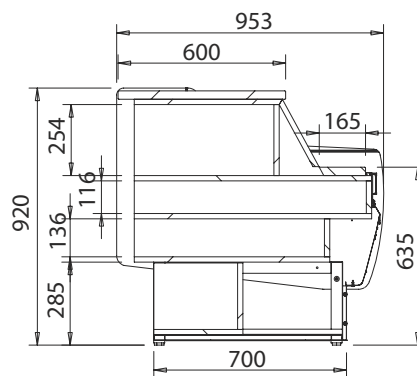

VMB M

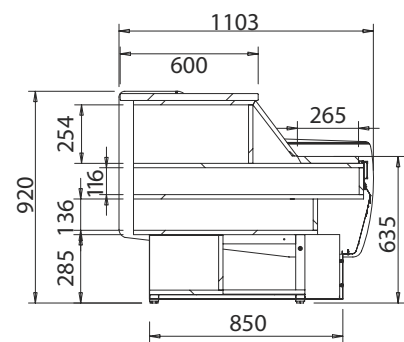

VMC M





9. Supermarket





9. Supermarket

Estructura de cristales de alta transparencia, rectos o curvos según modelo.

High transparency glass structure, flat or curved depending on the model.

Structure en verre à haute transparence, droite ou bombée selon le modèle.

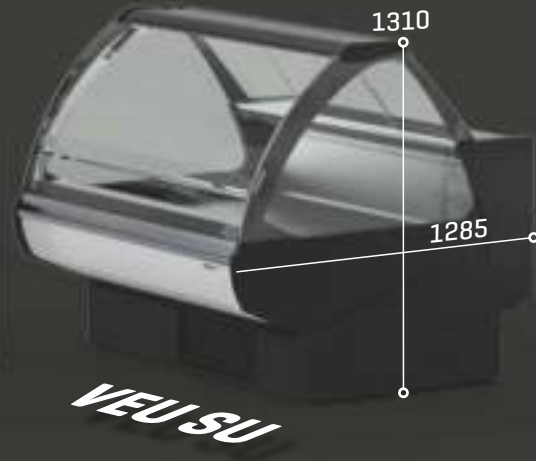
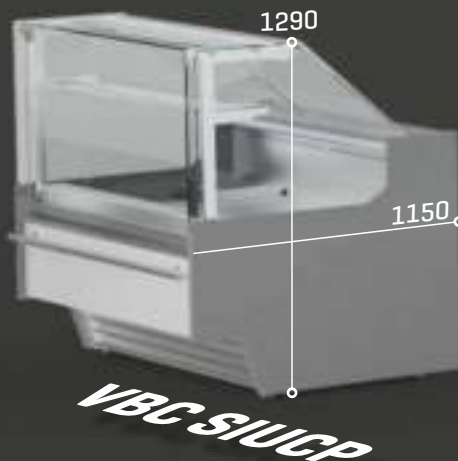
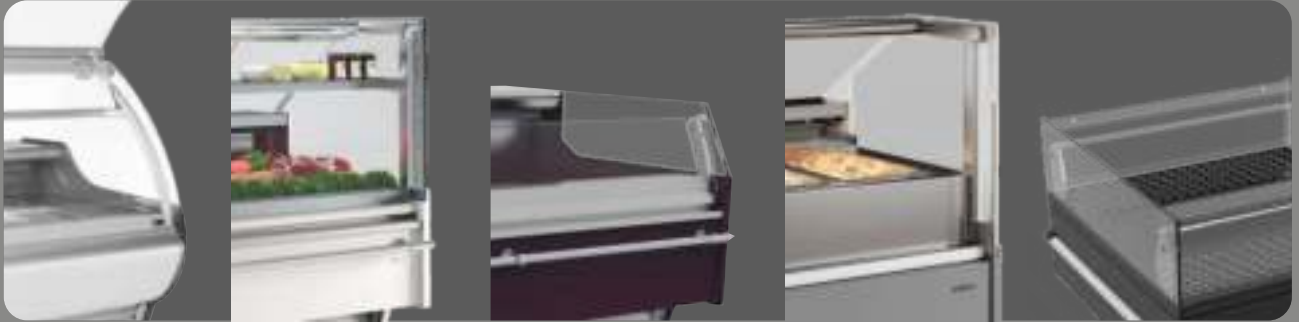

Iluminación / Lighting / Éclairage

Incorporación de iluminación LED, llegando a reducir el consumo energético entre un 80% y 90%, respecto a una bombilla tradicional.

LED lighting incorporated, reducing energetic consumption between 80% and 90% respect to a traditional light bulb.

Éclairage LED, réduisant la consommation énergétique entre 80% et 90%, par rapport à une ampoule traditionnelle.



Equipos con posibilidad de grupo remoto y grupo incorporado.

Devices with the possibility of remote group and integrated group.

Équipement avec la possibilité de groupe à distance et de groupe incorporé.

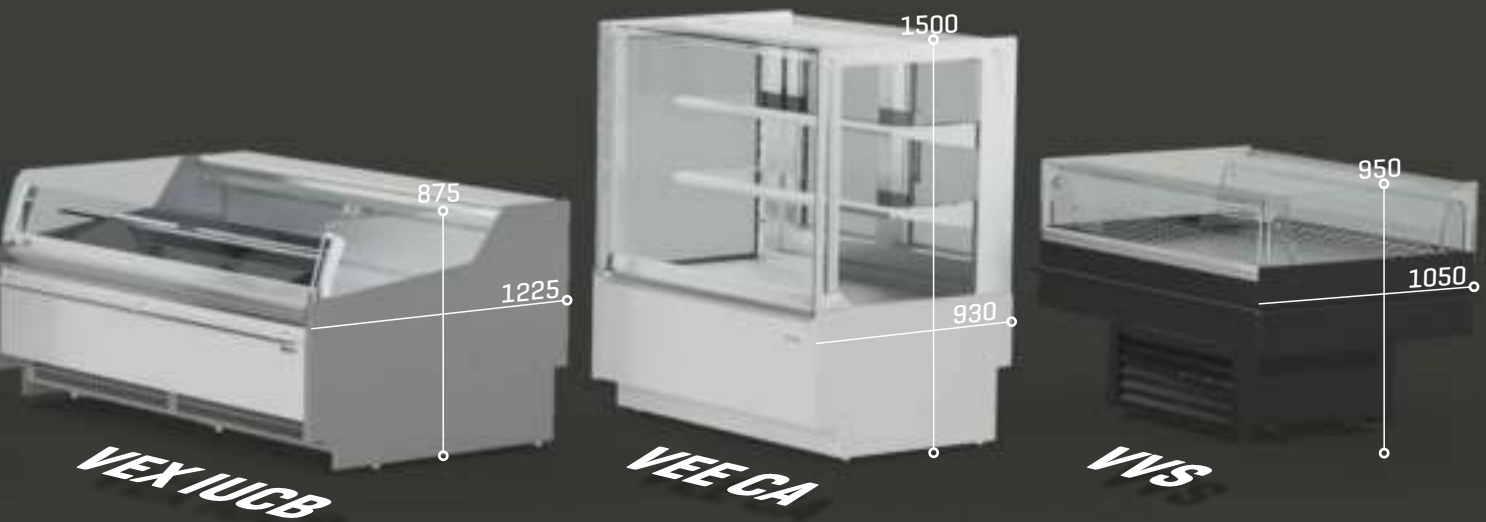

Máxima visibilidad de producto expuesto.

Maximum visibility of displayed product.

Visibilité maximale du produit exposé.



Amplia gama de opciones y posibilidades de personalización para exponer todo tipo de productos refrigerados sin envasar: carne, charcutería y delicatessen.

Wide range of options and customisation possibilities for displaying all types of unpackaged refrigerated products: meat, deli and delicatessen.

Nombreuses options et possibilités de personnalisation pour présenter tous les types de produits réfrigérés non emballés : viande, charcuterie et delicatessen.



9. Supermarket

VITRINAS / COUNTER CASES / VITRINES

Serie / Series / Série

MADRID

Vitrina expositora modular frío ventilado

266 - 273

Refrigerated modular display case
Vitrine d'exposition modulaire froid ventilé

Serie / Series / Série

VMD MADRID



VMD 9 RU/SU
VMD 9 RIU/SIU

VMD 12 RU/SU
VMD 12 RIU/SIU

VMD 15 RU/SU
VMD 15 RIU/SIU

VMD 18 RU/SU
VMD 18 RIU/SIU

VMD 25 RU/SU
VMD 25 RIU/SIU

VMD 31 RU/SU
VMD 31 RIU/SIU

VMD 37 RU/SU
VMD 37 RIU/SIU

R: CON RESERVA / WHIT STORAGE / AVEC RÉSERVE

S: SIN RESERVA / WHITOUT STORAGE / SANS RÉSERVE

GRUPO INCORPORADO /

PLUG IN / GROUPE

INCORPORÉ



VMD 90 AA RU/SU
VMD 90 AA RIU/SIU

VMD 45 AA RU/SU
VMD 45 AA RIU/SIU

VMD 90 AC RU/SU
VMD 90 AC RIU/SIU

VMD 45 AC RU/SU
VMD 45 AC RIU/SIU

VMD 9 C

VMD 12 M

VMD 15 M

R: CON RESERVA / WHIT STORAGE / AVEC RÉSERVE

S: SIN RESERVA / WHITOUT STORAGE / SANS RÉSERVE

MUEBLE CAJA / COUNTER CASE / MEUBLE CAISSE

Serie / Series / Série

BARCELONA

Vitrina expositora modular frío ventilado

274 - 293

Refrigerated modular display case
Vitrine d'exposition modulaire froid ventilé

Serie / Series / Série

VBC BARCELONA



VBC 9 RU/SU
VBC 9 RIU/SIU

VBC 12 RU/SU
VBC 12 RIU/SIU

VBC 15 RU/SU
VBC 15 RIU/SIU

VBC 18 RU/SU
VBC 18 RIU/SIU

VBC 25 RU/SU
VBC 25 RIU/SIU

VBC 31 RU/SU
VBC 31 RIU/SIU

VBC 37 RU/SU
VBC 37 RIU/SIU

R: CON RESERVA / WHIT STORAGE / AVEC RÉSERVE

S: SIN RESERVA / WHITOUT STORAGE / SANS RÉSERVE

GRUPO INCORPORADO /

PLUG IN / GROUPE

INCORPORÉ



VBC 90 AA RU/SU
VBC 90 AA RIU/SIU

VBC 45 AA RU/SU
VBC 45 AA RIU/SIU

VBC 90 AC RU/SU
VBC 90 AC RIU/SIU

VBC 45 AC RU/SU
VBC 45 AC RIU/SIU

VBC 9 C

VBC 12 M

VBC 15 M

VBC 12 MHD

R: CON RESERVA / WHIT STORAGE / AVEC RÉSERVE

S: SIN RESERVA / WHITOUT STORAGE / SANS RÉSERVE

MUEBLE CAJA / COUNTER CASE / MEUBLE CAISSE

Serie / Series / Série

VBC BARCELONA



VBC 9 RUCP/SUCP
VBC 9 RIUCP/SIUCP

VBC 12 RUCP/SUCP
VBC 12 RIUCP/SIUCP

VBC 15 RUCP/SUCP
VBC 15 RIUCP/SIUCP

VBC 18 RUCP/SUCP
VBC 18 RIUCP/SIUCP

VBC 25 RUCP/SUCP
VBC 25 RIUCP/SIUCP

VBC 31 RUCP/SUCP
VBC 31 RIUCP/SIUCP

VBC 37 RUCP/SUCP
VBC 37 RIUCP/SIUCP

RCP: CON RESERVA / WHIT STORAGE / AVEC RÉSERVE

SCP: SIN RESERVA / WHITOUT STORAGE / SANS RÉSERVE

GRUPO INCORPORADO /

PLUG IN / GROUPE

INCORPORÉ



VBC90 A RUCP/SUCP
VBC90 A RIUCP/SIUCP

VBC90 C RUCP/SUCP
VBC90 C RIUCP/SIUCP

RCP: CON RESERVA / WHIT STORAGE / AVEC RÉSERVE

SCP: SIN RESERVA / WHITOUT STORAGE / SANS RÉSERVE

VBC 9 CP

VBC 12 MP

VBC 15 MP

VBC 12 MHD

MUEBLE CAJA / COUNTER CASE / MEUBLE CAISSE



VBC9SUCB
VBC9SIUCB

VBC12SUCB
VBC12SIUCB

VBC15SUCB
VBC15SIUCB

VBC18SUCB
VBC18SIUCB

VBC25SUCB
VBC25SIUCB

VBC9SIUCB
VBC9SIUCB

VBC12SIUCB
VBC12SIUCB

VBC15SIUCB
VBC15SIUCB

VBC18SIUCB
VBC18SIUCB

VBC25SIUCB
VBC25SIUCB

CURVA / CURVED / BOMBÉE

RECTA / FLAT / DROITE

+Info: www.infrico.com

Serie / Series / Série

**VMD
MADRID**



VMD 9 R/S
VMD 9 RI/SI



VMD 12 R/S
VMD 12 RI/SI



VMD 15 R/S
VMD 15 RI/SI



VMD 18 R/S
VMD 18 RI/SI



VMD 25 R/S
VMD 25 RI/SI



VMD 31 R/S
VMD 31 RI/SI



VMD 37 R/S
VMD 37 RI/SI

R: CON RESERVA / WHIT STORAGE / AVEC RÉSERVE S: SIN RESERVA / WHITOUT STORAGE / SANS RÉSERVE

**GRUPO
REMOTO /
REMOTE /
GROUPE À
DISTANCE**



VMD 90 AA R/S
VMD 90 AA RI/SI



VMD 45 AA R/S
VMD 45 AA RI/SI



VMD 90 AC R/S
VMD 90 AC RI/SI



VMD 45 AC R/S
VMD 45 AC RI/SI



VMD 9 C



VMD 12 M



VMD 15 M

R: CON RESERVA / WHIT STORAGE / AVEC RÉSERVE
S: SIN RESERVA / WHITOUT STORAGE / SANS RÉSERVE

MUEBLE CAJA / COUNTER CASE / MEUBLE CAISSE

Serie / Series / Série

**VBC
BARCELONA**



VBC 9 R/S
VBC 9 RI/SI



VBC 12 R/S
VBC 12 RI/SI



VBC 15 R/S
VBC 15 RI/SI



VBC 18 R/S
VBC 18 RI/SI



VBC 25 R/S
VBC 25 RI/SI



VBC 31 R/S
VBC 31 RI/SI



VBC 37 R/S
VBC 37 RI/SI

R: CON RESERVA / WHIT STORAGE / AVEC RÉSERVE
S: SIN RESERVA / WHITOUT STORAGE / SANS RÉSERVE

**GRUPO
REMOTO /
REMOTE /
GROUPE À
DISTANCE**



VBC 90 AA R/S
VBC 90 AA RI/SI



VBC 45 AA R/S
VBC 45 AA RI/SI



VBC 90 AC R/S
VBC 90 AC RI/SI



VBC 45 AC R/S
VBC 45 AC RI/SI



VBC 9 C



VBC 12 M



VBC 15 M



VBC 12 MHD

R: CON RESERVA / WHIT STORAGE / AVEC RÉSERVE
S: SIN RESERVA / WHITOUT STORAGE / SANS RÉSERVE

MUEBLE CAJA / COUNTER CASE / MEUBLE CAISSE

Serie / Series / Série

**VBC
BARCELONA**



VBC 9 RCP/SCP
VBC 9 RICP/SICP



VBC 12 RCP/SCP
VBC 12 RICP/SICP



VBC 15 RCP/SCP
VBC 15 RICP/SICP



VBC 18 RCP/SCP
VBC 18 RICP/SICP



VBC 25 RCP/SCP
VBC 25 RICP/SICP



VBC 31 RCP/SCP
VBC 31 RICP/SICP



VBC 37 RCP/SCP
VBC 37 RICP/SICP

RCP: CON RESERVA / WHIT STORAGE / AVEC RÉSERVE
SCP: SIN RESERVA / WHITOUT STORAGE / SANS RÉSERVE

**GRUPO
REMOTO /
REMOTE /
GROUPE À
DISTANCE**



VBC90 AARRCP/AARSCP
VBC90 AIRRCPI/ARISCP



VBC90 ACRRCP/ACRSCP
VBC90 CRRCP/CRSCP

RCP: CON RESERVA / WHIT STORAGE / AVEC RÉSERVE
SCP: SIN RESERVA / WHITOUT STORAGE / SANS RÉSERVE



VBC9SCB
VBC9SICB



VBC12SCB
VBC12SICB



VBC15SCB
VBC15SICB



VBC18SCB
VBC18SICB



VBC25SCB
VBC25SICB



VBC9SCBCP
VBC9SICBCP



VBC12SCBCP
VBC12SICBCP



VBC15SCBCP
VBC15SICBCP



VBC18SCBCP
VBC18SICBCP



VBC25SCBCP
VBC25SICBCP

CURVA / CURVED / BOMBÉE

RECTA / FLAT / DROITE

9. Supermarket

VITRINAS / COUNTER CASES / VITRINES

Serie / Series / Série

EUROPA

Vitrina expositora modular frío ventilado

Refrigerated modular display case

Vitrine d'exposition modulaire froid ventilé

296 - 311

Serie / Series / Série

VEU EUROPA



VEU 9 RU/SU
VEU 9 RIU/SIU

VEU 12 RU/SU
VEU 12 RIU/SIU

VEU 15 RU/SU
VEU 15 RIU/SIU

VEU 18 RU/SU
VEU 18 RIU/SIU

VEU 25 RU/SU
VEU 25 RIU/SIU

VEU 31 RU/SU
VEU 31 RIU/SIU

VEU 37 RU/SU
VEU 37 RIU/SIU

CRISTAL CURVO / CURVED GLASS / VITRE BOMBÉE

R: CON RESERVA / WHIT STORAGE / AVEC RÉSERVE

S: SIN RESERVA / WHITOUT STORAGE / SANS RÉSERVE

GRUPO
INCORPORADO /
PLUG IN /
GROUPE
INCORPORÉ

VEU 9 RUCP/SUCP
VEU 9 RIUCP/SIUCP



VEU 12 RUCP/SUCP
VEU 12 RIUCP/SIUCP

VEU 15 RUCP/SUCP
VEU 15 RIUCP/SIUCP

VEU 18 RUCP/SUCP
VEU 18 RIUCP/SIUCP

VEU 25 RUCP/SUCP
VEU 25 RIUCP/SIUCP

VEU 31 RUCP/SUCP
VEU 31 RIUCP/SIUCP

VEU 37 RUCP/SUCP
VEU 37 RIUCP/SIUCP

CRISTAL RECTO / FLAT GLASS / VITRE DROITE

RCP: CON RESERVA / WHIT STORAGE / AVEC RÉSERVE

SCP: SIN RESERVA / WHITOUT STORAGE / SANS RÉSERVE

Serie / Series / Série

VEU EUROPA

VEU 90 AA RU/SU
VEU 90 AA RIU/SIU

VEU 45 AA RN/SN
VEU 45 AA RIN/SIN

VEU 90 AC RU/SU
VEU 90 AC RIU/SIU

VEU 45 AC RU/SU
VEU 45 AC RIU/SIU

VEU 90 A RUCP/SUCP
VEU 90 A RIUCP/SIUCP

VEU 90 C RUCP/SUCP
VEU 90 C RIUCP/SIUCP

R: CON RESERVA / WHIT STORAGE / AVEC RÉSERVE

S: SIN RESERVA / WHITOUT STORAGE / SANS RÉSERVE

GRUPO
INCORPORADO /
PLUG IN /
GROUPE
INCORPORÉ

VEU 9 SUCB
VEU 9 SIUCB

VEU 12 SUCB
VEU 12 SIUCB

VEU 15 SUCB
VEU 15 SIUCB

VEU 18 SUCB
VEU 18 SIUCB

VEU 25 SUCB
VEU 25 SIUCB

VEU 9 C

VEU 12 M

VEU 15 M

MUEBLE CAJA / COUNTER CASE / MEUBLE CAISSE

Serie / Series / Série

VEX EXPERIENCE

Vitrina Experience para carne y charcutería

Experience display case for meat and deli products

Vitrine Experience pour la viande et les produits de charcuterie

280 - 325

Serie / Series / Série

VEX EXPERIENCE

VEX09UCP / IUCP

VEX12UCP / IUCP

VEX15UCP / IUCP

VEX18UCP / IUCP

VEX25UCP / IUCP

VEX31UCP / IUCP

VEX37UCP / IUCP

CRISTAL RECTO / FLAT GLASS / VITRE DROITE

I: PLANO INOX / STAINLESS STEEL SURFACE / PLAN INOX

GRUPO
INCORPORADO /
PLUG IN /
GROUPE
INCORPORÉ

VEX09 U / IU

VEX12 U / IU

VEX15 U / IU

VEX18 U / IU

VEX25 U / IU

VEX31 U / IU

VEX37 U / IU

CRISTAL CURVO / CURVED GLASS / VITRE BOMBÉE

I: PLANO INOX / STAINLESS STEEL SURFACE / PLAN INOX

VEX09 UCB / IUCB

VEX12 UCB / IUCB

VEX15 UCB / IUCB

VEX18 UCB / IUCB

VEX25 UCB / IUCB

CRISTAL BAJO / LOW GLASS / VITRE BASS

I: PLANO INOX / STAINLESS STEEL SURFACE / PLAN INOX

VEX90 ACU / ACIU

VEX90 AAU / AAIU

VEX45 ACU / ACIU

VEX45 AAU / AAIU

VEX90 ACUCP / ACIUCP

VEX90 AAUCP / AAIUCP

CURVA / CURVED / BOMBÉE
ÁNGULOS / ANGLES / ANGLES

I: PLANO INOX / STAINLESS STEEL SURFACE / PLAN INOX

Serie / Series / Série

VEX EXPERIENCE

VEX09 CA

VEX12 CA

VEX09 U CA

VEX12 U CA

VEX12 CP HT

VEX25 CP HT

REMOTA / REMOTE / GROUPE À DIST.

GRUPO INCORP. / PLUG IN / GR. INCORPORÉ

CALIENTE / HOT / CHAUDE

+Info: www.infrico.com

Serie / Series / Série

**VEU
EUROPA**



VEU 9 R/S / VEU 9 RI/SI VEU 12 R/S / VEU 12 RI/SI VEU 15 R/S / VEU 15 RI/SI VEU 18 R/S / VEU 18 RI/SI VEU 25 R/S / VEU 25 RI/SI VEU 31 R/S / VEU 31 RI/SI VEU 37 R/S / VEU 37 RI/SI

CRISTAL CURVO / CURVED GLASS / VITRE BOMBÉE

R: CON RESERVA / WHIT STORAGE / AVEC RÉSERVE S: SIN RESERVA / WHITOUT STORAGE / SANS RÉSERVE

**GRUPO
REMOTO /
REMOTE /
GROUPE À
DISTANCE**



VEU 9 RCP/SCP / VEU 9 RICP/SICP VEU 12 RCP/SCP / VEU 12 RICP/SICP VEU 15 RCP/SCP / VEU 15 RICP/SICP VEU 18 RCP/SCP / VEU 18 RICP/SICP VEU 25 RCP/SCP / VEU 25 RICP/SICP VEU 31 RCP/SCP / VEU 31 RICP/SICP VEU 37 RCP/SCP / VEU 37 RICP/SICP

CRISTAL RECTO / FLAT GLASS / VITRE DROITE

RCP: CON RESERVA / WHIT STORAGE / AVEC RÉSERVE SCP: SIN RESERVA / WHITOUT STORAGE / SANS RÉSERVE

Serie / Series / Série

**VEU
EUROPA**



VEU 90 AA R/S / VEU 90 AA RI/SI VEU 45 AA RN/SN / VEU 45 AA RIN/SIN VEU 90 AC R/S / VEU 90 AC RI/SI VEU 45 AC R/S / VEU 45 AC RI/SI VEU 90 A RCP/SCP / VEU 90 A RICP/SICP VEU 90 C RCP/SCP / VEU 90 C RICP/SICP

R: CON RESERVA / WHIT STORAGE / AVEC RÉSERVE

S: SIN RESERVA / WHITOUT STORAGE / SANS RÉSERVE

**GRUPO
REMOTO /
REMOTE /
GROUPE À
DISTANCE**



VEU 9 SCB / VEU 9 SICB VEU 12 SCB / VEU 12 SICB VEU 15 SCB / VEU 15 SICB VEU 18 SCB / VEU 18 SICB VEU 25 SCB / VEU 25 SICB

Serie / Series / Série

**VEX
EXPERIENCE**



VEX09 CP / ICP / VEX12 CP / ICP / VEX15 CP / ICP / VEX18 CP / ICP / VEX25 CP / ICP / VEX31 CP / ICP / VEX37 CP / ICP

RECTA / FLAT / DROITE

I: PLANO INOX / STAINLESS STEEL SURFACE / PLAN INOX

**GRUPO
REMOTO /
REMOTE /
GROUPE À
DISTANCE**



VEX09 / I / VEX12 / I / VEX15 / I / VEX18 / I / VEX25 / I / VEX31 / I / VEX37 / I

CURVA / CURVED / BOMBÉE

I: PLANO INOX / STAINLESS STEEL SURFACE / PLAN INOX



VEX09 CB / I CB / VEX12 CB / I CB / VEX15 CB / I CB / VEX18 CB / I CB / VEX25 CB / I CB

CRISTAL BAJO / LOW GLASS / VITRE BASS

I: PLANO INOX / STAINLESS STEEL SURFACE / PLAN INOX



VEX90 AC / ACI / VEX90 AA / AAI / VEX45 AC / ACI / VEX45 AA / AAI / VEX90 ACCP / ACICP / VEX90 AACP / AAICP

CURVA / CURVED / BOMBÉE
ÁNGULOS / ANGLES / ANGLES

RECTA / FLAT / DROITE
I: PLANO INOX / STAINLESS STEEL SURFACE / PLAN INOX

9. Supermarket

VITRINAS / COUNTER CASES / VITRINES

Serie / Series / Série

VEE	Vitrina Experience estrecha comida preparada Experience narrow display counter for ready meals Vitrine Experience étroite pour plats cuisinés	326 - 331
------------	--	------------------

Serie / Series / Série

VISIÓN	Vitrinas promocionales Promotional cases Vitrines promotionnelles	336 - 337
---------------	--	------------------

ISLAS / HORIZONTAL FREEZER / ÎLOT CONGÉLATION

Serie / Series / Série

GD / COMBI	Isla congelación estática / Armario combi superior Static horizontal freezer / Top combi cabinet / Îlot panoramique de congélation fermé statique / Armoire combi supérieure	340 - 341
-------------------	---	------------------

+Info: www.infrico.com

Serie / Series / Série

NEW

**VEE
EXPERIENCE
FOR EAT**

GRUPO REMOTO / REMOTE / GROUPE À DISTANCE



GRUPO INCORPORADO / PLUG IN / GROUPE INCORPORÉ



Serie / Series / Série

NEW

**VISIÓN
VVS
SVS**









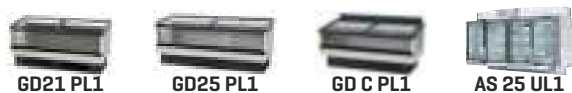







Serie / Series / Série

NEW

**ISLAS
GD / COMBI**



Vitrina expositora modular frío ventilado grupo incorporado / Refrigerated modular plugin display case / Vitrine présentation froid ventilé canalisable groupe incorporé

		CON RESERVA / WHIT STORAGE / AVEC RÉSERVE - RIU: Plano Inox / Stainless Steel exhibition plan / Plan d'exposition Inox						
MODELO MODELE MODÈLE								
Precio Price Prix	RU RIU							
		SIN RESERVA / WHITOUT STORAGE / SANS RÉSERVE - SIU: Plano Inox / Stainless Steel exhibition plan / Plan d'exposition Inox						
MODELO MODELE MODÈLE								
Precio Price Prix	SU SIU							
Medidas Measures Mesures	(mm)	938 x 1150 x 1290 mm.	1250 x 1150 x 1290 mm.	1562 x 1150 x 1290 mm.	1875 x 1150 x 1290 mm.	2500 x 1150 x 1290 mm.	3125 x 1150 x 1290 mm.	3750 x 1150 x 1290 mm.
Temperatura Temperature Température	(°C)	0°C/+6°C						
Clase Climática Climatic class Classe climatique	(°C)	3 / 25°C						
Tensión/Frecuencia Electrical data Tension électrique		230V/1ph/50Hz						
Controlador Controller Régulateur		Digital						
Material Matériel	[EXT/INT]	Ext: acero plastificado / Plastified stainless steel / Acier plastifié Encimera / Worktop / Dessous: Inox Aisi 304 Plano exposición / Exhibition plan / Plan d'exposition: Acero plastif. / Plastif. Stainless steel/ Acier plastifié [Mod RU/SU] - Inox Aisi 304 [Mod. RIU/SIU]						
Aislamiento Isolation Isolation	(mm)	40kg/m ³ / Free CFC's / Zero ODP-GWP						
Capacidad Capacity Capacité	(L)	124	165	206	248	330	413	495
Superficie exposición Surface exhibition Surface d'exposition	(m ²)	0,96	1,28	1,59	1,91	2,55	3,19	3,83
Compresor Compressor Compresseur	(HP)	1/3	1/3	1/2	3/4	1	3/4	3/4
Estantes Shelving Étagères		1						
Costados (2) Sides (2) Joues (2)	(mm)	30+30						
Sistema de frío Cooling System Système de froid		Ventilado / Ventilated / Ventilé						
Desescarche Defrost Dégivrage		Automático / Automatic / Automatique						
Evaporación Evaporation Évaporation		Forzada / Forced / Ventilé						
Potencia Puissance	(W)	385	395	530	581	767	1324	1341
Potencia frig. Cooling capacity Puissance Frig.	(W A -10°C)	-	-	-	-	-	-	-
Consumo Consumption Consommation	(kWh/ 24h)	4.61	4.74	6.36	6.98	9.21	15.9	16.1
Refrigerante Refrigerant Gaz		R-290						
Opcional Optional Options	Puertas correderas traseras / Rear sliding doors / Portes coulissantes arrière							
	(PUEV9CT)	(PUEV12CT)	(PUEV15CT)	(PUEV18CT)	(PUEV25CT)	(PUEV31CT)	(PUEV37CT)	
	Cortinas traseras nocturnas / Night curtains / Rideaux de nuit							
	(CCNV9)	(CCNV12)	(CCNV15)	(CCNV18)	(CCNV25)	(CCNV31)	(CCNV37)	
Opcional Optional Options	Doble plano [sin reserva] / Double surface [without storage] / Double plan [sans réserve]							
	(DPEXVMDBC9S)	(DPEXVMDBC12S)	(DPEXVMDBC15S)	(DPEXVMDBC18S)	(DPEXVMDBC25S)	(DPEXVMDBC31S)	(DPEXVMDBC37S)	

Laterales no incluidos en el precio
Side panels not included in price
Joues non incluses dans le prix

Serie / Series / Série **MADRID**

+Info: www.infrico.com

VMD 25 RU



Detalle reserva
Storage detail
Détail réserve

Laterales / Sides / Joues

NO	
Izquierdo Left Gauche	Derecho Right Droite



VMD 18 SU

Ext. Estándar / Standar / Standard

Blanco/White/ Blanc	Ral 1001	Ral 1018
Ral 2003	Ral 3003	Ral 3020
Design 2108025	Ral 5015	Ral 4007
Ral 6002	Design 1107060	Design 3504035
Ral 9006	Ral 7016	Ral 8017

**Colores fuera de carta /
Colors outside of letter /
Couleurs spéciales, hors palette**

RAL		NO RAL	
Epoxi	Líquida/ Liquid/ Liquide	Epoxi	Líquida/ Liquid/ Liquide
[x unidad/x unit/x unité]		Consultar / Consulter / Consulter	
+10 días laborables / +10 work days / +10 jours ouvrés		Consultar / Consulter / Consulter	

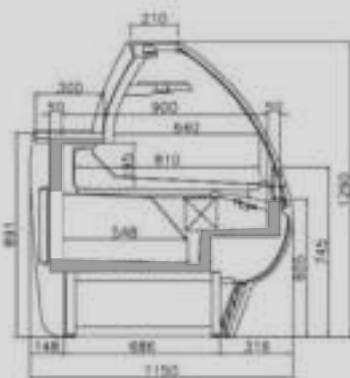



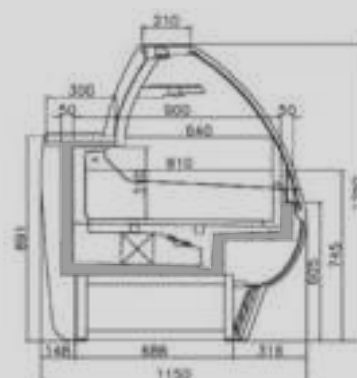











VMD R [con reserva]
[Whit storage]
[Avec réserve]



VMD S [Sin reserva]
[Whitout storage]
[Sans réserve]

Vitrina expositora modular frío ventilado grupo remoto / Refrigerated modular display remote case / Vitrine présentation froid ventilé canalisable groupe à distance

		CON RESERVA / WHIT STORAGE / AVEC RÉSERVE - RI: Plano Inox / Stainless Steel exhibition plan / Plan d'exposition Inox						
MODELO MODELE MODÈLE		 VMD 9 R/RI	 VMD 12 R/RI	 VMD 15 R/RI	 VMD 18 R/RI	 VMD 25 R/RI	 VMD 31 R/RI	 VMD 37 R/RI
Precio Price Prix	R RI							
		SIN RESERVA / WHITOUT STORAGE / SANS RÉSERVE - SI: Plano Inox / Stainless Steel exhibition plan / Plan d'exposition Inox						
MODELO MODELE MODÈLE		 VMD 9 S/SI	 VMD 12 S/SI	 VMD 15 S/SI	 VMD 18 S/SI	 VMD 25 S/SI	 VMD 31 S/SI	 VMD 37 S/SI
Precio Price Prix	S SI							
Medidas Measures Mesures	(mm)	938 x 1150 x 1290 mm.	1250 x 1150 x 1290 mm.	1562 x 1150 x 1290 mm.	1875 x 1150 x 1290 mm.	2500 x 1150 x 1290 mm.	3125 x 1150 x 1290 mm.	3750 x 1150 x 1290 mm.
Temperatura Temperature Température	(°C)	0°C/+6°C						
Clase Climática Climatic class Classe climatique	(°C)	3 / 25°C						
Tensión/Frecuencia Electrical data Tension électrique		230V/1ph/50Hz						
Controlador Controller Régulateur		Digital						
Material Matériel	[EXT/INT]	Ext: acero plastificado / Plastified stainless steel / Acier plastifié Encimera / Worktop / Dessous: Inox Aisi 304 Plano exposición / Exhibition plan / Plan d'exposition: Acero plastif./Plastif. Stainless steel/ Acier plastifié (Mod R/S) - Inox Aisi 304 (Mod. RI/SI)						
Aislamiento Isolation Isolation	(mm)	40kg/m ³ / Free CFC's / Zero ODP-GWP						
Capacidad Capacity Capacité	(L)	124	165	206	248	330	413	495
Superficie exposición Surface exhibition Surface d'exposition	(m ²)	0,96	1,28	1,59	1,91	2,55	3,19	3,83
Compresor Compressor Compresseur	(HP)	-	-	-	-	-	-	-
Estantes Shelving Étagères		1						
Costados (2) Sides (2) Joues (2)	(mm)	30+30						
Sistema de frío Cooling System Système de froid		Ventilado / Ventilated / Ventilé						
Desescarche Defrost Dégivrage		Automático / Automatic / Automatique						
Evaporación Evaporation Évaporation		Forzada / Forced / Ventilé						
Potencia Power Puissance	(W)	-	-	-	-	-	-	-
Potencia frig. Cooling capacity Puissance Frig.	(W A -10°C)	-	-	-	-	-	-	-
Consumo Consumption Consommation	(kWh/ 24h)	556	741	926	1112	1483	1853	2224
Refrigerante Refrigerant Gaz		R-290						
Opcional Optional Options		Puertas correderas traseras / Rear sliding doors / Portes coulissantes arrière						
		(PUEV9CT)	(PUEV12CT)	(PUEV15CT)	(PUEV18CT)	(PUEV25CT)	(PUEV31CT)	(PUEV37CT)
		Cortinas traseras nocturnas / Night curtains / Rideaux de nuit						
		(CCNV9)	(CCNV12)	(CCNV15)	(CCNV18)	(CCNV25)	(CCNV31)	(CCNV37)
	Doble plano [sin reserva] / Double surface [without storage] / Double plan [sans réserve]							
	(DPEXVMDBC9S)	(DPEXVMDBC12S)	(DPEXVMDBC15S)	(DPEXVMDBC18S)	(DPEXVMDBC25S)	(DPEXVMDBC31S)	(DPEXVMDBC37S)	

Laterales no incluidos en el precio
Side panels not included in price
Joues non incluses dans le prix

Serie / Series / Série **MADRID**

+Info: www.infrico.com

VMD 18 SU



Laterales / Sides / Joutes

NO	
Izquierdo Left Gauche	Derecho Right Droite



VMD 25 RI



Detalle reserva
Storage detail
Détail réserve

Ext. Estándar / Standar / Standard

Blanco/White/ Blanc	Ral 1001	Ral 1018
Ral 2003	Ral 3003	Ral 3020
Design 2108025	Ral 5015	Ral 4007
Ral 6002	Design 1107060	Design 3504035
Ral 9006	Ral 7016	Ral 8017

**Colores fuera de carta /
Colors outside of letter /
Couleurs spéciales, hors palette**

RAL		NO RAL	
Epoxi	Líquida/ Liquid/ Liquide	Epoxi	Líquida/ Liquid/ Liquide
[x unidad/x unit/x unité]		Consultar / Consulter / Consulter	
+10 días laborables / +10 work days / +10 jours ouvrés		Consultar / Consulter / Consulter	

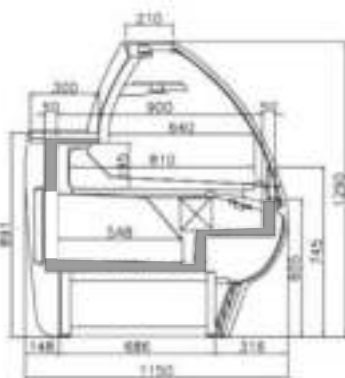



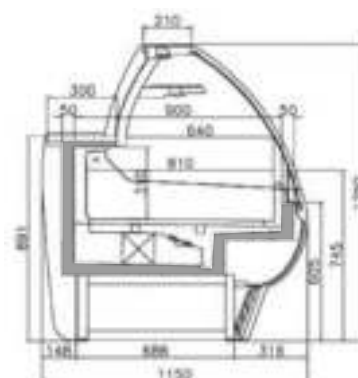







VMD R (con reserva)
[Whit storage]
[Avec réserve]



VMD S [Sin reserva]
[Whitout storage]
[Sans réserve]

Vitrina expositora modular frío ventilado grupo incorporado /
Refrigerated modular plugin display case /
Vitrine présentation froid ventilé canalisable groupe incorporé

Mueble caja /
Counter case /
Meuble de comptoir

		CON RESERVA / WHIT STORAGE / AVEC RÉSERVE RIU: Plano Inox / Stainless Steel exhibition plan / Plan d'exposition Inox				MUEBLE CAJA / COUNTER CASE / MEUBLE DE COMPTOIR		
MODELO MODELE MODÈLE								
Precio Price Prix	RU RIU							
		SIN RESERVA / WHITOUT STORAGE / SANS RÉSERVE SIU: Plano Inox / Stainless Steel exhibition plan / Plan d'exposition Inox						
MODELO MODELE MODÈLE						-	-	-
Precio Price Prix	SU SIU							
Medidas Measures Mesures	(mm)	1326 x 1150 x 1290 mm.	1108 x 1150 x 1290 mm.	1887 x 1150 x 1290 mm.	1470 x 1150 x 1290 mm.	938 x 1150 x 906 mm.	1250 x 1150 x 906 mm.	1562 x 1150 x 906 mm.
Temperatura Temperature Température	(°C)	0°C/+6°C				-		
Clase Climática Climatic class Classe climatique	(°C)	3 / 25°C				-		
Tensión/Frecuencia Electrical data Tension électrique		230V/1ph/50Hz				-		
Controlador Controller Régulateur		Digital				-		
Material Matériel	[EXT/INT]	Ext: acero plastificado / Plastified stainless steel / Acier plastifié Encimera / Worktop / Dessous: Inox Aisi 304 Plano exposición / Exhibition plan / Plan d'exposition: Acero plastif. / Plastif. Stainless steel/ Acier plastifié [Mod RU/SU] - Inox Aisi 304 [Mod. RIU/SIU]						
Aislamiento Isolation Isolation	(mm)	40kg/m ³ / Free CFC's / Zero ODP-GWP				-		
Capacidad Capacity Capacité	(L)	-	-	-	-	-	-	-
Superficie exposición Surface exhibition Surface d'exposition	(m ²)	1,15	0,63	1,49	0,75	0,55	0,74	0,92
Compresor Compressor Compresseur	(HP)	5/8	3/8	3/4	1/2	-	-	-
Estantes Shelving Étagères		1				-		
Costados (2) Sides (2) Joues (2)	(mm)	30+30						
Sistema de frío Cooling System Système de froid		Ventilado / Ventilated / Ventilé				-		
Desescarche Defrost Dégivrage		Automático / Automatic / Automatique				-		
Evaporación Evaporation Évaporation		Forzada / Forced / Ventilé				-		
Potencia Power Puissance	(W)	990	670	1060	740	-	-	-
Potencia frig. Cooling capacity Puissance Frig.	(W A -10°C)	1096	676	1315	817	-	-	-
Consumo Consumption Consommation	(kWh/ 24h)	13,9	9,4	14,8	10,4	-	-	-
Refrigerante Refrigerant Gaz		R-290				-		
Opcional Optional Options		Puertas corred. tras. / Rear sliding doors / Portes couliss. arrière [PUEV90AACT]	Puertas corred. tras. / Rear sliding doors / Portes couliss. arrière [PUEV45AACT]	Puertas corred. tras. / Rear sliding doors / Portes couliss. arrière [PUEV90ACCT]	Puertas corred. tras. / Rear sliding doors / Portes couliss. arrière [PUEV45ACCT]	-		

Laterales no incluidos en el precio
Side panels not included in price
Joues non incluses dans le prix

Serie / Series / Série **MADRID**

+Info: www.infrico.com

Lineal VMD
VMD Linear assembly
Assemblage lineaire VMD

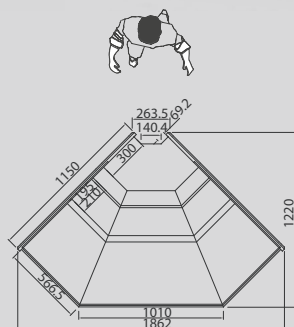
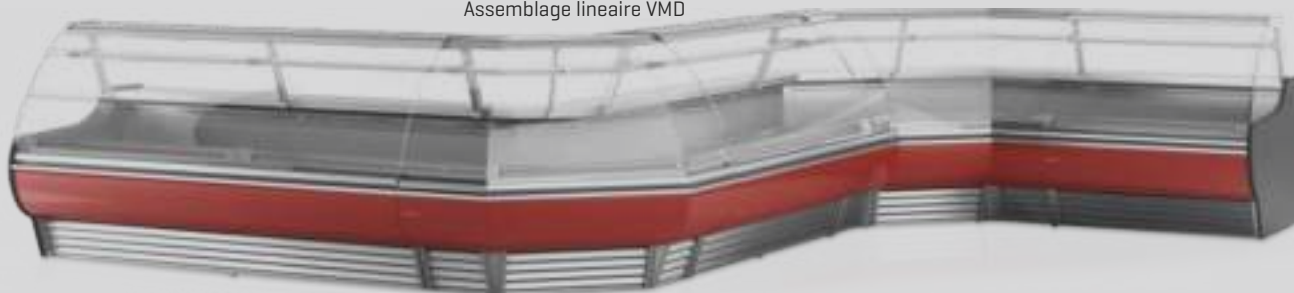

VMD 90 AA RU

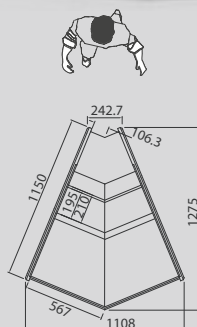

VMD 45 AA RU

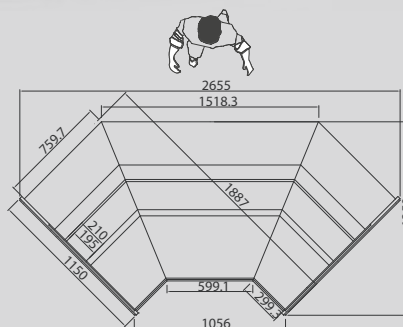

VMD 90 AC RU

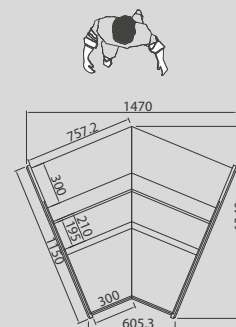

VMD 45 AC RU

Laterales / Sides / Jous

VMD C/M: SÍ

Laterales / Sides / Jous

VMD 90/45: NO

Izquierdo Left Gauche	Derecho Right Droite
-----------------------------	----------------------------

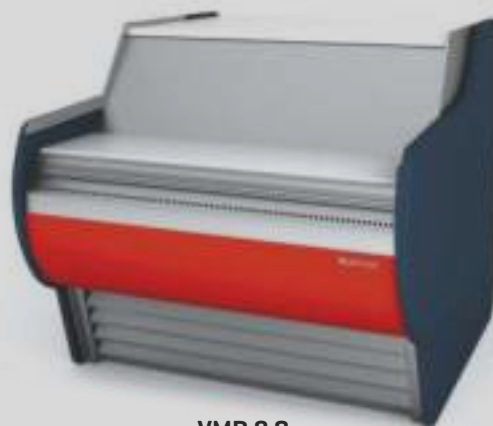

VMD 9 C

Ext. Estándar / Standar / Standard

Blanco/White/ Blanc	Ral 1001	Ral 1018
Ral 2003	Ral 3003	Ral 3020
Design 2108025	Ral 5015	Ral 4007
Ral 6002	Design 1107060	Design 3504035
Ral 9006	Ral 7016	Ral 8017

**Colores fuera de carta /
Colors outside of letter /
Couleurs spéciales, hors palette**











RAL		NO RAL	
Epoxi	Líquida/ Liquid/ Liquide	Epoxi	Líquida/ Liquid/ Liquide
[x unidad/x unit/x unité]		Consultar / Consulter / Consulter	
+10 días laborables / +10 work days / +10 jours ouvrés		Consultar / Consulter / Consulter	



VMD 12 M

Vitrina expositora modular frío ventilado grupo remoto /
Refrigerated modular display remote case /
Vitrine présentation froid ventilé canalisable groupe à distance

Mueble caja /
Counter case /
Meuble de comptoir

		CON RESERVA / WHIT STORAGE / AVEC RÉSERVE RI: Plano Inox / Stainless Steel exhibition plan / Plan d'exposition Inox				MUEBLE CAJA / COUNTER CASE / MEUBLE DE COMPTOIR		
MODELO MODELE MODÈLE								
Precio Price Prix	R RI							
MODELO MODELE MODÈLE		SIN RESERVA / WHITOUT STORAGE / SANS RÉSERVE SI: Plano Inox / Stainless Steel exhibition plan / Plan d'exposition Inox						
MODELO MODELE MODÈLE						-	-	-
Precio Price Prix	S SI							
Medidas Measures Mesures	(mm)	1326 x 1150 x 1290 mm.	1108 x 1150 x 1290 mm.	1887 x 1150 x 1290 mm.	1470 x 1150 x 1290 mm.	938 x 1150 x 906 mm.	1250 x 1150 x 906 mm.	1562 x 1150 x 906 mm.
Temperatura Temperature Température	(°C)	0°C/+6°C				-		
Clase Climática Climatic class Classe climatique	(°C)	3 / 25°C				-		
Tensión/Frecuencia Electrical data Tension électrique		230V/1ph/50Hz				-		
Controlador Controller Régulateur		Digital				-		
Material Matériel	(EXT/INT)	Ext: acero plastificado / Plastified stainless steel / Acier plastifié Encimera / Worktop / Dessous: Inox Aisi 304 Plano exposición / Exhibition plan / Plan d'exposition: Acero plastif./Plastif. Stainless steel/ Acier plastifié (Mod R/S) - Inox Aisi 304 (Mod. RI/SI)						
Aislamiento Isolation Isolation	(mm)	40kg/m ³ / Free CFC's / Zero ODP-GWP				-		
Capacidad Capacity Capacité	(L)	-	-	-	-	-	-	-
Superficie exposición Surface exhibition Surface d'exposition	(m ²)	1,15	0,63	1,49	0,75	0,55	0,74	0,92
Compresor Compressor Compresseur	(HP)	-	-	-	-	-	-	-
Estantes Shelving Étagères		1				-		
Costados (2) Sides (2) Joues (2)	(mm)	30+30						
Sistema de frío Cooling System Système de froid		Ventilado / Ventilated / Ventilé				-		
Desescarche Defrost Dégivrage		Automático / Automatic / Automatique				-		
Evaporación Evaporation Évaporation		Forzada / Forced / Ventilé				-		
Potencia Power Puissance	(W)	-	-	-	-	-	-	-
Potencia frig. Cooling capacity Puissance Frig.	(W A -10°C)	780	391	1151	777	-	-	-
Consumo Consumption Consommation	(kWh/ 24h)	-	-	-	-	-	-	-
Refrigerante Refrigerant Gaz		R-290				-		
Opcional Optional Options		Puertas corred. tras. / Rear sliding doors / Portes couliss. arrière (PUEV90AACT)	Puertas corred. tras. / Rear sliding doors / Portes couliss. arrière (PUEV45AACT)	Puertas corred. tras. / Rear sliding doors / Portes couliss. arrière (PUEV90ACCT)	Puertas corred. tras. / Rear sliding doors / Portes couliss. arrière (PUEV45ACCT)	-		

Laterales no incluidos en el precio
Side panels not included in price
Joues non incluses dans le prix

Serie / Series / Série **MADRID**

+Info: www.infrico.com

Lineal VMD
VMD Linear assembly
Assemblage lineaire VMD

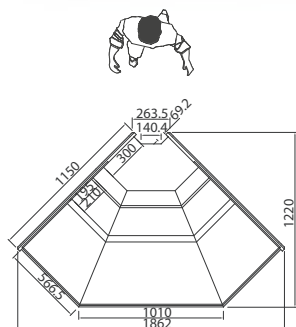
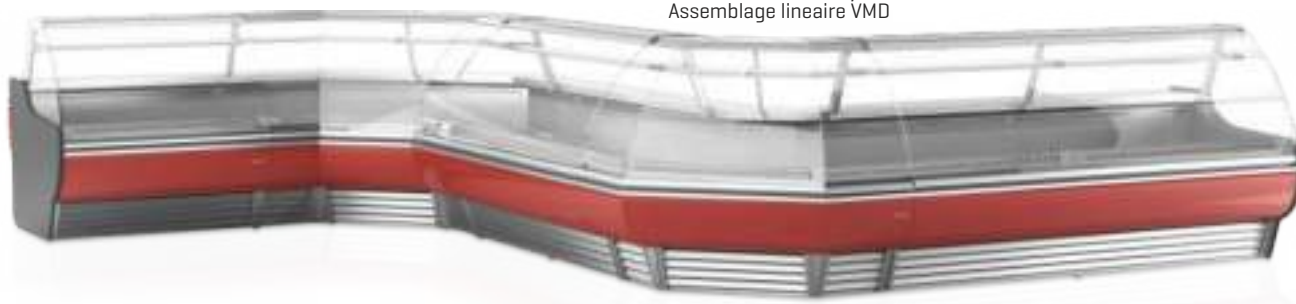

VMD 90 AA R

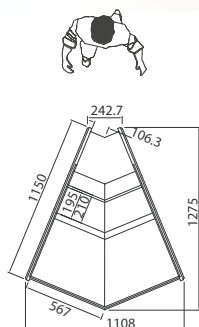

VMD 45 AA R

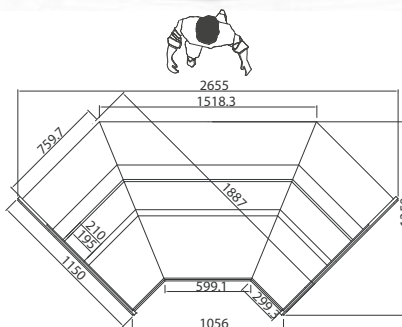

VMD 90 AC R

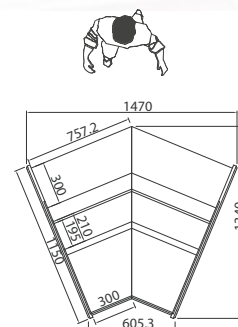

VMD 45 AC R

Laterales / Sides / Jous

VMD C/M: SÍ

Laterales / Sides / Jous

VMD 90/45: NO

Izquierdo Left Gauche	Derecho Right Droite
-----------------------------	----------------------------



VMD 12 M

Ext. Estándar / Standar / Standard

Blanco/White/ Blanc	Ral 1001	Ral 1018
Ral 2003	Ral 3003	Ral 3020
Design 2108025	Ral 5015	Ral 4007
Ral 6002	Design 1107060	Design 3504035
Ral 9006	Ral 7016	Ral 8017

**Colores fuera de carta /
Colors outside of letter /
Couleurs spéciales, hors palette**















RAL		NO RAL	
Epoxi	Líquida/ Liquid/ Liquide	Epoxi	Líquida/ Liquid/ Liquide
[x unidad/x unit/x unité]		Consultar / Consulter / Consulter	
+10 días laborables / +10 work days / +10 jours ouvrés		Consultar / Consulter / Consulter	



VMD 9 C

Vitrina expositora modular frío ventilado grupo incorporado / Refrigerated modular plugin display case / Vitrine présentation froid ventilé canalisable groupe incorporé

CON RESERVA / WITH STORAGE / AVEC RÉSERVE - RIU: Plano Inox / Stainless Steel exhibition plan / Plan d'exposition Inox

MODELO MODELE MODÈLE								
Precio Price Prix	RU							
	RIU							
	SIN RESERVA / WITHOUT STORAGE / SANS RÉSERVE - SIU: Plano Inox / Stainless Steel exhibition plan / Plan d'exposition Inox							
MODELO MODELE MODÈLE								
Precio Price Prix	SU							
	SIU							
Medidas Measures Mesures	(mm)	938 x 1150 x 1290 mm.	1250 x 1150 x 1290 mm.	1562 x 1150 x 1290 mm.	1875 x 1150 x 1290 mm.	2500 x 1150 x 1290 mm.	3125 x 1150 x 1290 mm.	3750 x 1150 x 1290 mm.
Temperatura Temperature Température	(°C)	0°C/+6°C						
Clase Climática Climatic class Classe climatique	(°C)	3 / 25°C						
Tensión/Frecuencia Electrical data Tension électrique		230V/1ph/50Hz						
Controlador Controller Régulateur		Digital						
Material Matériel	[EXT/INT]	Ext: acero plastificado / Plastified stainless steel / Acier plastifié Encimera / Worktop / Dessous: Inox Aisi 304 Plano exposición / Exhibition plan / Plan d'exposition: Acero plastif. / Plastif. Stainless steel/ Acier plastifié [Mod RU/SIU] - Inox Aisi 304 [Mod. RIU/SIU]						
Aislamiento Isolation Isolation	(mm)	40kg/m ³ / Free CFC's / Zero ODP-GWP						
Capacidad Capacity Capacité	(L)	82	109	137	164	219	273	328
Superficie exposición Surface exhibition Surface d'exposition	(m ²)	0,92	1,23	1,53	1,84	2,45	3,06	3,68
Compresor Compressor Compresseur	(HP)	1/3	1/2	3/4	3/4	1+1/4	1+1/4	1+1/4
Estantes Shelving Étagères		1 [+1 opcional/optional/en option]						
Costados (2) Sides (2) Joues (2)	(mm)	30+30						
Sistema de frío Cooling System Système de froid		Ventilado / Ventilated / Ventilé						
Desescarche Defrost Dégivrage		Automático / Automatic / Automatique						
Evaporación Evaporation Évaporation		Forzada / Forced / Ventilé						
Potencia Power Puissance	(W)	394	531	590	681	1115	2166	2190
Potencia frig. Cooling capacity Puissance Frig.	(W A -10°C)	-	-	-	-	-	-	-
Consumo Consumption Consommation	(kWh/ 24h)	5.18	7.01	7.8	8.9	14.6	28.6	28.9
Refrigerante Refrigerant Gaz		R-290						
		Puertas correderas traseras / Rear sliding doors / Portes coulissantes arrière						
		(PUEV9CT)	(PUEV12CT)	(PUEV15CT)	(PUEV18CT)	(PUEV25CT)	(PUEV31CT)	(PUEV37CT)
		Cortinas traseras nocturnas / Night curtains / Rideaux de nuit						
		(CCNV9)	(CCNV12)	(CCNV15)	(CCNV18)	(CCNV25)	(CCNV31)	(CCNV37)
		Cristal calefactado curvo / Heated curved frontal glass / Vitre bombé chauffée						
		(CRCCTVEU9)	(CRCCTVEU12)	(CRCCTVEU15)	(CRCCTVEU18)	(CRCCTVEU25)	(CRCCTVEU31)	(CRCCTVEU37)

Laterales no incluidos en el precio
Side panels not included in price
Joues non incluses dans le prix

Serie / Series / Série **BARCELONA**

+Info: www.infrico.com

VBC 15 RU



Laterales / Sides / Joues

NO	
Izquierdo Left Gauche	Derecho Right Droite

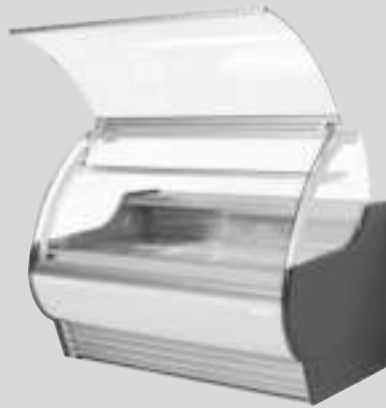

Ext. Estándar / Standar / Standard

Blanco/White/ Blanc	Ral 1001	Ral 1018
Ral 2003	Ral 3003	Ral 3020
Design 2108025	Ral 5015	Ral 4007
Ral 6002	Design 1107060	Design 3504035
Ral 9006	Ral 7016	Ral 8017

**Colores fuera de carta /
Colors outside of letter /
Couleurs spéciales, hors palette**

RAL		NO RAL	
Epoxi	Líquida/ Liquid/ Liquide	Epoxi	Líquida/ Liquid/ Liquide
[x unidad/x unit/x unité]		Consultar / Consultar / Consulter	
+10 días laborables / +10 work days / +10 jours ouvrés		Consultar / Consultar / Consulter	

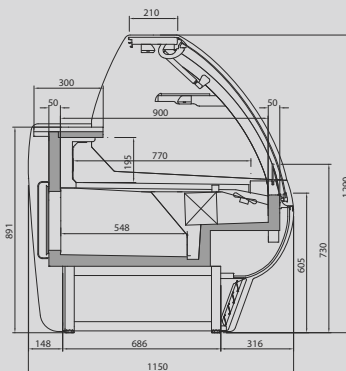



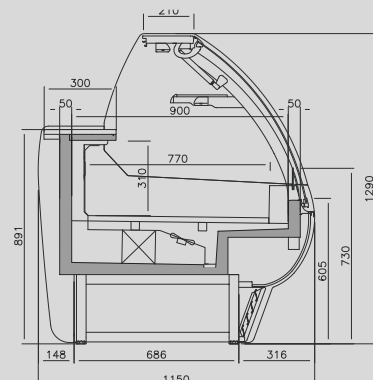









**VBC RU/RIU [con reserva]
[Whit storage]
[Avec réserve]**



**VBC SU/SIU [Sin reserva]
[Whitout storage]
[Sans réserve]**

Vitrina expositora modular frío ventilado grupo incorporado /
Refrigerated modular plugin display case /
Vitrine présentation froid ventilé canalisable groupe incorporé

Mueble caja /
Counter case /
Meuble de comptoir

		CON RESERVA / WHIT STORAGE / AVEC RÉSERVE RIU: Plano Inox / Stainless Steel exhibition plan / Plan d'exposition Inox				MUEBLE CAJA / COUNTER CASE / MEUBLE DE COMPTOIR			
MODELO MODELE MODÈLE									
Precio Price Prix	RU RIU								
		SIN RESERVA / WHITOUT STORAGE / SANS RÉSERVE SIU: Plano Inox / Stainless Steel exhibition plan / Plan d'exposition Inox							
MODELO MODELE MODÈLE						-	-	-	-
Precio Price Prix	SU SIU								
Medidas Measures Mesures	(mm)	1326 x 1150 x 1290 mm.	1108 x 1150 x 1290 mm.	1887 x 1150 x 1290 mm.	1470 x 1150 x 1290 mm.	938 x 1150 x 906 mm.	1250 x 1150 x 906 mm.	1562 x 1150 x 906 mm.	1250 x 1150 x 906 mm.
Temperatura Temperature Température	(°C)	0°C/+6°C							
Clase Climática Climatic class Classe climatique	(°C)	3 / 25°C							
Tensión/Frecuencia Electrical data Tension électrique		230V/1ph/50Hz							
Controlador Controller Régulateur		Digital							
Material Matériel	[EXT/INT]	Ext: acero plastificado / Plastified stainless steel / Acier plastifié Encimera / Worktop / Dessous: Inox Aisi 304 Plano exposición / Exhibition plan / Plan d'exposition: Acero plastif./ Plastif. Stainless steel/ Acier plastifié (Mod RU/SU) - Inox Aisi 304 (Mod. RIU/SIU)							
Aislamiento Isolation Isolation	(mm)	40kg/m ³ / Free CFC's / Zero ODP-GWP							
Capacidad Capacity Capacité	(L)	-	-	-	-	-	-	-	-
Superficie exposición Surface exhibition Surface d'exposition	(m ²)	1,09	0,60	1,43	0,72	0,55	0,74	0,92	
Compresor Compressor Compresseur	(HP)	5/8	3/8	3/4	1/2	-	-	-	
Estantes Shelving Étagères		1 [+ 1 OPCIONAL/OPTIONAL/OPTION]							
Costados (2) Sides (2) Joues (2)	(mm)	30+30							
Sistema de frío Cooling System Système de froid		Ventilado / Ventilated / Ventilé							
Desescarche Defrost Dégivrage		Automático / Automatic / Automatique							
Evaporación Evaporation Évaporation		Forzada / Forced / Ventilé							
Potencia Power Puissance	(W)	1025	700	1110	780	-	-	-	-
Potencia frig. Cooling capacity Puissance Frig.	(W A -10°C)	-	-	-	-	-	-	-	-
Consumo Consumption Consommation	(kWh/ 24h)	14,4	9,8	15,5	10,9	-	-	-	-
Refrigerante Refrigerant Gaz		R-290							
Opcional Optional Options		Puertas correderas tras. / Rear sliding doors / Portes couliss. arrière (PUEVBC90AACT)	Puertas correderas tras. / Rear sliding doors / Portes couliss. arrière (PUEVBC45AACT)	Puertas correderas tras. / Rear sliding doors / Portes couliss. arrière (PUEVBC90ACCT)	Puertas correderas tras. / Rear sliding doors / Portes couliss. arrière (PUEVBC45ACCT)				

Laterales no incluidos en el precio
Side panels not included in price
Joues non incluses dans le prix

Serie / Series / Série **BARCELONA**

+Info: www.infrico.com

Lineal VBC
VBC Linear assembly
Assemblage lineaire VBC

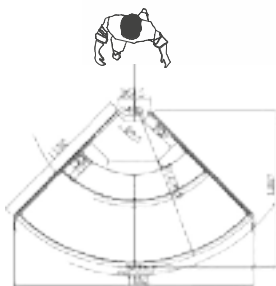

VBC 90 AA RU/RIU
VBC 90 AA SU/SIU



VBC 45 AA RU/RIU
VBC 45 AA SU/SIU

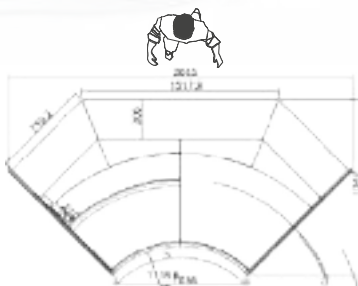

VBC 90 AC RU/RIU
VBC 90 AC SU/SIU

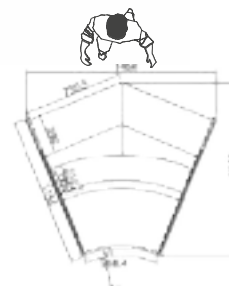

VBC 45 AC RU/RIU
VBC 45 AC SU/SIU

Laterales / Sides / Joutes

VBC C/M/MHD: SÍ

Laterales / Sides / Joutes

VBC 90/45: NO

Izquierdo Left Gauche	Derecho Right Droite
-----------------------------	----------------------------



VBC 12 M



VBC 9 C

Ext. Estándar / Standar / Standard

Blanco/White/ Blanc	Ral 1001	Ral 1018
Ral 2003	Ral 3003	Ral 3020
Design 2108025	Ral 5015	Ral 4007
Ral 6002	Design 1107060	Design 3504035
Ral 9006	Ral 7016	Ral 8017

**Colores fuera de carta /
Colors outside of letter /
Couleurs spéciales, hors palette**

RAL		NO RAL	
Epoxi	Líquida/ Liquid/ Liquide	Epoxi	Líquida/ Liquid/ Liquide
[x unidad/x unit/x unité]		Consultar / Consultar / Consulter	
+10 días laborables / +10 work days / +10 jours ouvrés		Consultar / Consultar / Consulter	

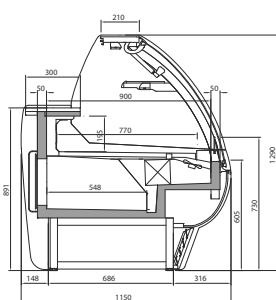

VBC RU [con reserva]
[Whit storage][Avec réserve]

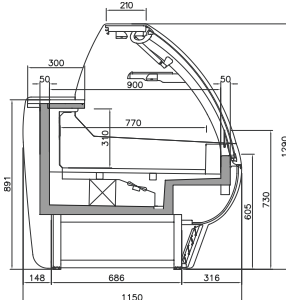



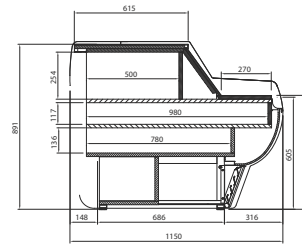











VBC SU [Sin reserva]
[Whitout storage][Sans réserve]



VBC

Vitrina expositora modular frío ventilado grupo remoto / Refrigerated modular display remote case / Vitrine présentation froid ventilé canalisable groupe à distance

CON RESERVA / WHIT STORAGE / AVEC RÉSERVE - RI: Plano Inox / Stainless Steel exhibition plan / Plan d'exposition Inox

MODELO MODELE MODÈLE								
Precio Price Prix	R							
	RI							
	SIN RESERVA / WHITOUT STORAGE / SANS RÉSERVE - SI: Plano Inox / Stainless Steel exhibition plan / Plan d'exposition Inox							
MODELO MODELE MODÈLE								
Precio Price Prix	S							
	SI							
Medidas Mesures Mesures	(mm)	938 x 1150 x 1290 mm.	1250 x 1150 x 1290 mm.	1562 x 1150 x 1290 mm.	1875 x 1150 x 1290 mm.	2500 x 1150 x 1290 mm.	3125 x 1150 x 1290 mm.	3750 x 1150 x 1290 mm.
Temperatura Temperature Température	(°C)	0°C/+6°C						
Clase Climática Climatic class Classe climatique	(°C)	3 / 25°C						
Tensión/Frecuencia Electrical data Tension électrique		230V/1ph/50Hz						
Controlador Controller Régulateur		Digital						
Material Matériel Matériel	[EXT/INT]	Ext: acero plastificado / Plastified stainless steel / Acier plastifié Encimera / Worktop / Dessous: Inox Aisi 304 Plano exposición / Exhibition plan / Plan d'exposition: Acero plastif. / Plastif. Stainless steel/ Acier plastifié [Mod RU/SU] - Inox Aisi 304 [Mod. RIU/SIU]						
Aislamiento Isolation Isolation	(mm)	40kg/m ³ / Free CFC's / Zero ODP-GWP						
Capacidad Capacity Capacité	(L)	82	109	137	164	219	273	328
Superficie exposición Surface exhibition Surface d'exposition	(m ²)	0,92	1,23	1,53	1,84	2,45	3,06	3,68
Compresor Compressor Compresseur	(HP)	-	-	-	-	-	-	-
Estantes Shelving Étagères		1 [+1 opcional/optional/en option]						
Costados (2) Sides (2) Joues (2)	(mm)	30+30						
Sistema de frío Cooling System Système de froid		Ventilado / Ventilated / Ventilé						
Desescarche Defrost Dégivrage		Automático / Automatic / Automatique						
Evaporación Evaporation Évaporation		Forzada / Forced / Ventilé						
Potencia Power Puissance	(W)	-	-	-	-	-	-	-
Potencia frig. Cooling capacity Puissance Frig.	(W A -10°C)	623	830	1037	1245	1660	2075	2490
Consumo Consumption Consommation	(kWh/ 24h)	-	-	-	-	-	-	-
Refrigerante Refrigerant Gaz		R-290						
Opcional Optional Options	Puertas correderas traseras / Rear sliding doors / Portes coulissantes arrière							
	(PUEV9CT)	(PUEV12CT)	(PUEV15CT)	(PUEV18CT)	(PUEV25CT)	(PUEV31CT)	(PUEV37CT)	
	Cortinas traseras nocturnas / Night curtains / Rideaux de nuit							
	(CCNV9)	(CCNV12)	(CCNV15)	(CCNV18)	(CCNV25)	(CCNV31)	(CCNV37)	
Opcional Optional Options	Cristal calefactado curvo / Heated curved frontal glass / Vitre bombé chauffée							
	(CRCCTVEU9)	(CRCCTVEU12)	(CRCCTVEU15)	(CRCCTVEU18)	(CRCCTVEU25)	(CRCCTVEU31)	(CRCCTVEU37)	

Laterales no incluidos en el precio
Side panels not included in price
Joues non incluses dans le prix

Serie / Series / Série **BARCELONA**

+Info: www.infrico.com

VBC 15 RI



Laterales / Sides / Joutes

NO	
Izquierdo Left Gauche	Derecho Right Droite



Ext. Estándar / Standar / Standard

Blanco/White/ Blanc	Ral 1001	Ral 1018
Ral 2003	Ral 3003	Ral 3020
Design 2108025	Ral 5015	Ral 4007
Ral 6002	Design 1107060	Design 3504035
Ral 9006	Ral 7016	Ral 8017

Colores fuera de carta /
Colors outside of letter /
Couleurs spéciales, hors palette

RAL		NO RAL	
Epoxi	Líquida/ Liquid/ Liquide	Epoxi	Líquida/ Liquid/ Liquide
[x unidad/x unit/x unité]		Consultar / Consultar / Consulter	
+10 días laborables / +10 work days / +10 jours ouvrés		Consultar / Consultar / Consulter	

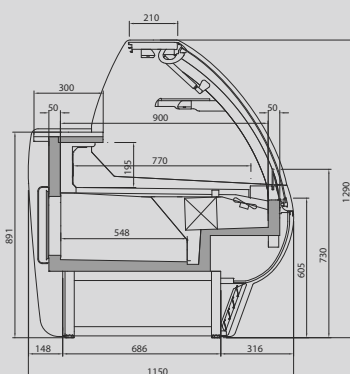



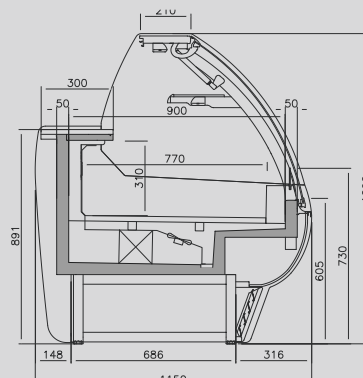









VBC R/RI [con reserva]
[Whit storage]
[Avec réserve]



VBC S/SI [Sin reserva]
[Whitout storage]
[Sans réserve]

Vitrina expositora modular frío ventilado grupo remoto /
Refrigerated modular display remote case /
Vitrine présentation froid ventilé canalisable groupe à distance

Mueble caja /
Counter case /
Meuble de comptoir

		CON RESERVA / WHIT STORAGE / AVEC RÉSERVE RI: Plano Inox / Stainless Steel exhibition plan / Plan d'exposition Inox				MUEBLE CAJA / COUNTER CASE / MEUBLE DE COMPTOIR			
MODELO MODELE MODÈLE									
Precio Price Prix	R RI								
		SIN RESERVA / WHITOUT STORAGE / SANS RÉSERVE SIU: Plano Inox / Stainless Steel exhibition plan / Plan d'exposition Inox							
MODELO MODELE MODÈLE						-	-	-	-
Precio Price Prix	S SI								
Medidas Measures Mesures	(mm)	1326 x 1150 x 1290 mm.	1108 x 1150 x 1290 mm.	1887 x 1150 x 1290 mm.	1470 x 1150 x 1290 mm.	938 x 1150 x 906 mm.	1250 x 1150 x 906 mm.	1562 x 1150 x 906 mm.	1250 x 1150 x 906 mm.
Temperatura Temperature Température	(°C)	0°C/+6°C							
Clase Climática Climatic class Classe climatique	(°C)	3 / 25°C							
Tensión/Frecuencia Electrical data Tension électrique		230V/1ph/50Hz							
Controlador Controller Régulateur		Digital							
Material Matériel	[EXT/INT]	Ext: acero plastificado / Plastified stainless steel / Acier plastifié Encimera / Worktop / Dessous: Inox Aisi 304 Plano exposición / Exhibition plan / Plan d'exposition: Acero plastif./ Plastif. Stainless steel/ Acier plastifié [Mod RU/SU] - Inox Aisi 304 [Mod. RIU/SIU]							
Aislamiento Isolation Isolation	(mm)	40kg/m ³ / Free CFC's / Zero ODP-GWP							
Capacidad Capacity Capacité	(L)	-	-	-	-	-	-	-	-
Superficie exposición Surface exhibition Surface d'exposition	(m ²)	1,09	0,60	1,43	0,72	0,55	0,74	0,92	
Compresor Compressor Compresseur	(HP)	-	-	-	-	-	-	-	-
Estantes Shelving Étagères		1 [+ 1 OPCIONAL/OPTIONAL/OPTION]							
Costados (2) Sides (2) Joues (2)	(mm)	30+30							
Sistema de frío Cooling System Système de froid		Ventilado / Ventilated / Ventilé							
Desescarche Defrost Dégivrage		Automático / Automatic / Automatique							
Evaporación Evaporation Évaporation		Forzada / Forced / Ventilé							
Potencia Power Puissance	(W)	-	-	-	-	-	-	-	-
Potencia frig. Cooling capacity Puissance Frig.	(W A -10°C)	304	403	11598	801	-	-	-	-
Consumo Consumption Consommation	(kWh/ 24h)	-	-	-	-	-	-	-	-
Refrigerante Refrigerant Gaz		R-290							
Opcional Optional Options		Puertas correderas tras. / Rear sliding doors / Portes couliss. arrière (PUEVBC90AACT)	Puertas correderas tras. / Rear sliding doors / Portes couliss. arrière (PUEVBC45AACT)	Puertas correderas tras. / Rear sliding doors / Portes couliss. arrière (PUEVBC90ACCT)	Puertas correderas tras. / Rear sliding doors / Portes couliss. arrière (PUEVBC45ACCT)				

Laterales no incluidos en el precio
Side panels not included in price
Joues non incluses dans le prix

Serie / Series / Série **BARCELONA**

+Info: www.infrico.com

Lineal VBC
VBC Linear assembly
Assemblage lineaire VBC

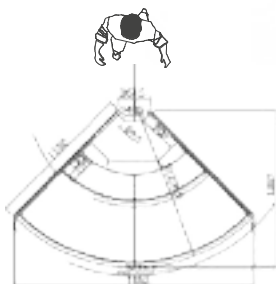

VBC 90 AA R/RI
VBC 90 AA S/SI

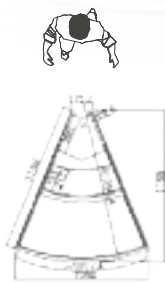

VBC 45 AA R/RI
VBC 45 AA S/SI

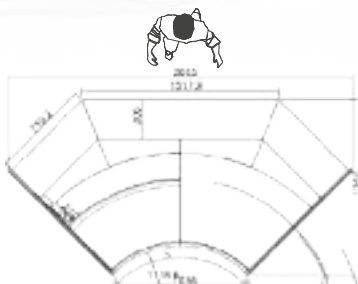

VBC 90 AC R/RI
VBC 90 AC S/SI

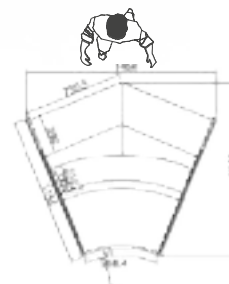

VBC 45 AC R/RI
VBC 45 AC S/SI

Laterales / Sides / Joutes

VBC C/M/MHD: SÍ

Laterales / Sides / Joutes

VBC 90/45: NO

Izquierdo Left Gauche	Derecho Right Droite
-----------------------------	----------------------------



VBC 12 M

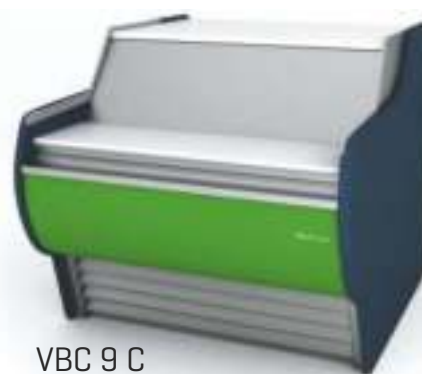

VBC 9 C

Ext. Estándar / Standar / Standard

Blanco/White/ Blanc	Ral 1001	Ral 1018
Ral 2003	Ral 3003	Ral 3020
Design 2108025	Ral 5015	Ral 4007
Ral 6002	Design 1107060	Design 3504035
Ral 9006	Ral 7016	Ral 8017

**Colores fuera de carta /
Colors outside of letter /
Couleurs spéciales, hors palette**

RAL		NO RAL	
Epoxi	Líquida/ Liquid/ Liquide	Epoxi	Líquida/ Liquid/ Liquide
[x unidad/x unit/x unité]		Consultar / Consultar / Consulter	
+10 días laborables / +10 work days / +10 jours ouvrés		Consultar / Consultar / Consulter	

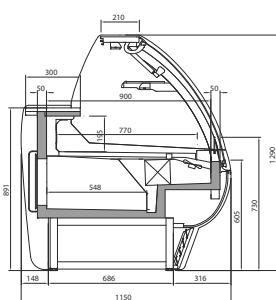

VBC R/RI [con reserva]
[Whit storage][Avec réserve]

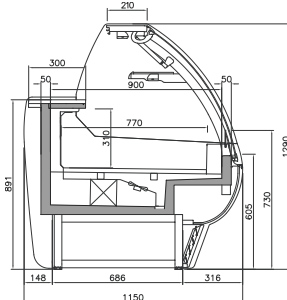



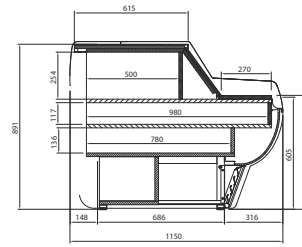











VBC S/SI [Sin reserva]
[Whitout storage][Sans réserve]



VBC

Vitrina expositora modular frío ventilado grupo incorporado / Refrigerated modular plugin display case / Vitrine présentation froid ventilé canalisable groupe incorporé

		CON RESERVA / WHIT STORAGE / AVEC RÉSERVE - RIU: Plano Inox / Stainless Steel exhibition plan / Plan d'exposition Inox						
MODELO MODELE MODÈLE								
Precio Price Prix	RUCP RIUCP							
		SIN RESERVA / WHITOUT STORAGE / SANS RÉSERVE - SIU: Plano Inox / Stainless Steel exhibition plan / Plan d'exposition Inox						
MODELO MODELE MODÈLE								
Precio Price Prix	SUCP SIUCP							
Medidas Mesures Mesures	[mm]	938 x 1150 x 1290 mm.	1250 x 1150 x 1290 mm.	1562 x 1150 x 1290 mm.	1875 x 1150 x 1290 mm.	2500 x 1150 x 1290 mm.	3125 x 1150 x 1290 mm.	3750 x 1150 x 1290 mm.
Temperatura Temperature Température	[°C]	0°C/+6°C						
Clase Climática Climatic class Classe climatique	[°C]	3 / 25°C						
Tensión/Frecuencia Electrical data Tension électrique		230V/1ph/50Hz						
Controlador Controller Régulateur		Digital						
Material Matériel Matériel	[EXT/INT]	Ext: acero plastificado / Plastified stainless steel / Acier plastifié Encimera / Worktop / Dessous: Inox Aisi 304 Plano exposición / Exhibition plan / Plan d'exposition: Acero plastif. / Plastif. Stainless steel/ Acier plastifié [Mod RU/SU] - Inox Aisi 304 [Mod. RIU/SIU]						
Aislamiento Isolation Isolation	[mm]	40kg/m ³ / Free CFC's / Zero ODP-GWP						
Capacidad Capacity Capacité	[L]	82	109	137	164	219	273	328
Superficie exposición Surface exhibition Surface d'exposition	[m ²]	0,92	1,23	1,53	1,84	2,45	3,06	3,68
Compresor Compressor Compresseur	[HP]	1/3	1/2	3/4	3/4	1+1/4	1+1/4	1+1/4
Estantes Shelving Étagères		1						
Costados (2) Sides (2) Joues (2)	[mm]	30+30						
Sistema de frío Cooling System Système de froid		Ventilado / Ventilated / Ventilé						
Desescarche Defrost Dégivrage		Automático / Automatic / Automatique						
Evaporación Evaporation Évaporation		Forzada / Forced / Ventilé						
Potencia Power Puissance	[W]	374	532	601	702	1177	1210	1234
Potencia frig. Cooling capacity Puissance Frig.	[W A -10°C]	-	-	-	-	-	-	-
Consumo Consumption Consommation	[kWh/ 24h]	4.7	6.4	7.2	8.4	12.7	14.5	16.3
Refrigerante Refrigerant Gaz		R-290						
Opcional Optional Options		Puertas correderas traseras / Rear sliding doors / Portes coulissantes arrière						
		[PUEV9CT]	[PUEV12CT]	[PUEV15CT]	[PUEV18CT]	[PUEV25CT]	[PUEV31CT]	[PUEV37CT]
		Cortinas traseras nocturnas / Night curtains / Rideaux de nuit						
		[CCNV9]	[CCNV12]	[CCNV15]	[CCNV18]	[CCNV25]	[CCNV31]	[CCNV37]

Laterales no incluidos en el precio
Side panels not included in price
Joues non inclus dans le prix

Serie / Series / Série **BARCELONA**

+Info: www.infrico.com

VBC 12 RUCP



VBC 12 SUCP



Laterales / Sides / Joues

NO	
Izquierdo Left Gauche	Derecho Right Droite

Ext. Estándar / Standar / Standard

Blanco/White/ Blanc	Ral 1001	Ral 1018
Ral 2003	Ral 3003	Ral 3020
Design 2108025	Ral 5015	Ral 4007
Ral 6002	Design 1107060	Design 3504035
Ral 9006	Ral 7016	Ral 8017

**Colores fuera de carta /
Colors outside of letter /
Couleurs spéciales, hors palette**

RAL		NO RAL	
Epoxi	Líquida/ Liquid/ Liquide	Epoxi	Líquida/ Liquid/ Liquide
[x unidad/x unit/x unité]		Consultar / Consultar / Consulter	
+10 días laborables / +10 work days / +10 jours ouvrés		Consultar / Consultar / Consulter	

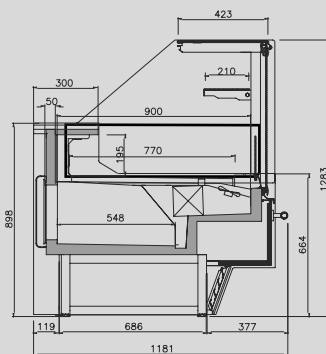



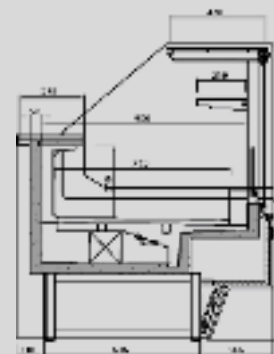

VBC RU (con reserva)
[Whit storage]
[Avec réserve]



VBC SU (Sin reserva)
[Whitout storage]
[Sans réserve]

Vitrina expositora modular frío ventilado grupo incorporado /
Refrigerated modular plugin display case /
Vitrine présentation froid ventilé canalisable groupe incorporé

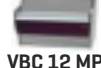
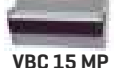
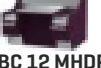
Mueble caja /
Counter case /
Meuble de comptoir

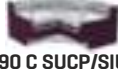
		CON RESERVA / WHIT STORAGE / AVEC RÉSERVE RIU: Plano Inox / Stainless Steel exhibition plan / Plan d'exposition Inox		MUEBLE CAJA / COUNTER CASE / MEUBLE DE COMPTOIR			
MODELO MODELE MODÈLE							
Precio Price Prix		RUCP	RIUCP				
MODELO MODELE MODÈLE		SIN RESERVA / WHITOUT STORAGE / SANS RÉSERVE SIU: Plano Inox / Stainless Steel exhibition plan / Plan d'exposition Inox					
				-	-	-	-
Precio Price Prix		SUCP	SIUCP				
Medidas Measures Mesures	(mm)	1887 x 1150 x 1290 mm.	1470 x 1150 x 1290 mm.	938 x 1150 x 906 mm.	1250 x 1150 x 906 mm.	1562 x 1150 x 906 mm.	1250 x 1150 x 906 mm.
Temperatura Temperature Température	(°C)	0°C/+6°C					
Clase Climática Climatic class Classe climatique	(°C)	3 / 25°C					
Tensión/Frecuencia Electrical data Tension électrique		230V/1ph/50Hz					
Controlador Controller Régulateur		Digital					
Material Matériel	[EXT/INT]	Ext: acero plastificado / Plastified stainless steel / Acier plastifié Encimera / Worktop / Dessous: Inox Aisi 304 Plano exposición / Exhibition plan / Plan d'exposition: Acero plastif./Plastif. Stainless steel/ Acier plastifié [Mod RU/SU] - Inox Aisi 304 [Mod. RIU/SIU]					
Aislamiento Isolation Isolation	(mm)	40kg/m ³ / Free CFC's / Zero ODP-GWP					
Capacidad Capacity Capacité	(L)	1,09	1,43	-	-	-	-
Superficie exposición Surface exhibition Surface d'exposition	(m ²)	-	-	0,55	0,74	0,92	-
Compresor Compressor Compresseur	(HP)	5/8	3/4	-	-	-	-
Estantes Shelving Étagères		-					
Costados (2) Sides (2) Joues (2)	(mm)	30+30					
Sistema de frío Cooling System Système de froid		Ventilado / Ventilated / Ventilé					
Desescarche Defrost Dégivrage		Automático / Automatic / Automatique					
Evaporación Evaporation Évaporation		Forzada / Forced / Ventilé					
Potencia Power Puissance	(W)	1025	1110	-	-	-	-
Potencia frig. Cooling capacity Puissance Frig.	(W A -10°C)	-	-	-	-	-	-
Consumo Consumption Consommation	(kWh/ 24h)	14,4	15,5	-	-	-	-
Refrigerante Refrigerant Gaz		R-290					
Opcional Optional Options		Puertas correderas tras. / Rear sliding doors / Portes couliss. arrière (PUEVBC90ARCT)	Puertas correderas tras. / Rear sliding doors / Portes couliss. arrière (PUEVBC90CRCT)				

Laterales no incluidos en el precio
Side panels not included in price
Joues non incluses dans le prix

Serie / Series / Série **BARCELONA**

+Info: www.infrico.com



Lineal VBC
VBC Linear assembly
Assemblage lineaire VBC



Laterales / Sides / Jous

VBC CP/MP/MHDP: SÍ

Laterales / Sides / Jous

VBC 90: NO

Izquierdo Left Gauche	Derecho Right Droite
-----------------------------	----------------------------

Ext. Estándar / Standar / Standard

Blanco/White/ Blanc	Ral 1001	Ral 1018
Ral 2003	Ral 3003	Ral 3020
Design 2108025	Ral 5015	Ral 4007
Ral 6002	Design 1107060	Design 3504035
Ral 9006	Ral 7016	Ral 8017

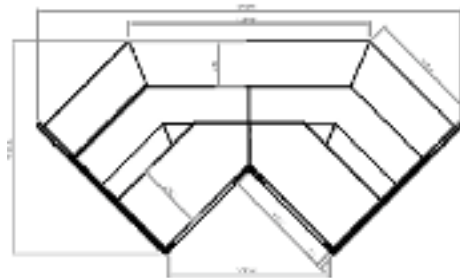

VBC 90 AC RUCP/SUCP

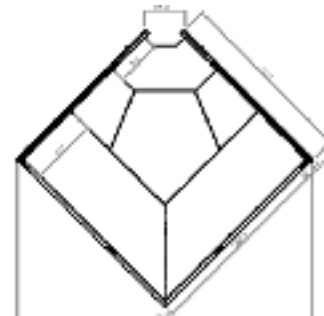

VBC 90 AA RUCP/SUCP

**Colores fuera de carta /
Colors outside of letter /
Couleurs spéciales, hors palette**

RAL		NO RAL	
Epoxi	Líquida/ Liquid/ Liquide	Epoxi	Líquida/ Liquid/ Liquide
[x unidad/x unit/x unité]		Consultar / Consultar / Consulter	
+10 días laborables / +10 work days / +10 jours ouvrés		Consultar / Consultar / Consulter	

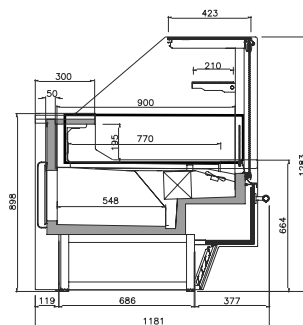

VBC RUCP (con reserva)
[Whit storage]
[Avec réserve]

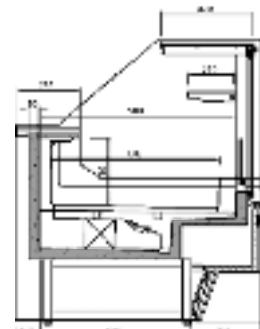















VBC SUCP (Sin reserva)
[Whitout storage]
[Sans réserve]



VBC P

Vitrina expositora modular frío ventilado grupo remoto / Refrigerated modular display remote case / Vitrine présentation froid ventilé canalisable groupe à distance

		CON RESERVA / WHIT STORAGE / AVEC RÉSERVE - RI: Plano Inox / Stainless Steel exhibition plan / Plan d'exposition Inox						
MODELO MODELE MODÈLE								
Precio Price Prix	RCP RICP							
		SIN RESERVA / WHITOUT STORAGE / SANS RÉSERVE - SIU: Plano Inox / Stainless Steel exhibition plan / Plan d'exposition Inox						
MODELO MODELE MODÈLE								
Precio Price Prix	SCP SICP							
Medidas Mesures Mesures	[mm]	938 x 1150 x 1290 mm.	1250 x 1150 x 1290 mm.	1562 x 1150 x 1290 mm.	1875 x 1150 x 1290 mm.	2500 x 1150 x 1290 mm.	3125 x 1150 x 1290 mm.	3750 x 1150 x 1290 mm.
Temperatura Temperature Température	[°C]	0°C/+6°C						
Clase Climática Climatic class Classe climatique	[°C]	3 / 25°C						
Tensión/Frecuencia Electrical data Tension électrique		230V/1ph/50Hz						
Controlador Controller Régulateur		Digital						
Material Matériel Matériel	[EXT/INT]	Ext: acero plastificado / Plastified stainless steel / Acier plastifié Encimera / Worktop / Dessous: Inox Aisi 304 Plano exposición / Exhibition plan / Plan d'exposition: Acero plastif./Plastif. Stainless steel/ Acier plastifié (Mod R/S) - Inox Aisi 304 (Mod. S/SI)						
Aislamiento Isolation Isolation	[mm]	40kg/m ³ / Free CFC's / Zero ODP-GWP						
Capacidad Capacity Capacité	[L]	82	109	137	164	219	273	328
Superficie exposición Surface exhibition Surface d'exposition	[m ²]	0,92	1,23	1,53	1,84	2,45	3,06	3,68
Compresor Compressor Compresseur	[HP]	-	-	-	-	-	-	-
Estantes Shelving Étagères		1						
Costados (2) Sides (2) Joues (2)	[mm]	30+30						
Sistema de frío Cooling System Système de froid		Ventilado / Ventilated / Ventilé						
Desescarche Defrost Dégivrage		Automático / Automatic / Automatique						
Evaporación Evaporation Évaporation		Forzada / Forced / Ventilé						
Potencia Power Puissance	[W]	-	-	-	-	-	-	-
Potencia frig. Cooling capacity Puissance Frig.	[W A -10°C]	656	874	1092	1315	1748	2184	2621
Consumo Consumption Consommation	[kWh/ 24h]	-	-	-	-	-	-	-
Refrigerante Refrigerant Gaz		R-290						
Opcional Optional Options		Puertas correderas traseras / Rear sliding doors / Portes coulissantes arrière						
		[PUEV9CT]	[PUEV12CT]	[PUEV15CT]	[PUEV18CT]	[PUEV25CT]	[PUEV31CT]	[PUEV37CT]
		Cortinas traseras nocturnas / Night curtains / Rideaux de nuit						
		[CCNV9]	[CCNV12]	[CCNV15]	[CCNV18]	[CCNV25]	[CCNV31]	[CCNV37]

Laterales no incluidos en el precio
Side panels not included in price
Joues non incluses dans le prix

Serie / Series / Série **BARCELONA**

+Info: www.infrico.com

VBC 12 SCP



Laterales / Sides / Joues

NO	
Izquierdo Left Gauche	Derecho Right Droite

Ext. Estándar / Standar / Standard

Blanco/White/ Blanc	Ral 1001	Ral 1018
Ral 2003	Ral 3003	Ral 3020
Design 2108025	Ral 5015	Ral 4007
Ral 6002	Design 1107060	Design 3504035
Ral 9006	Ral 7016	Ral 8017

VBC 12 RCP



Colores fuera de carta /
Colors outside of letter /
Couleurs spéciales, hors palette

RAL		NO RAL	
Epoxi	Líquida/ Liquid/ Liquide	Epoxi	Líquida/ Liquid/ Liquide
[x unidad/x unit/x unité]		Consultar / Consultar / Consulter	
+10 días laborables / +10 work days / +10 jours ouvrés		Consultar / Consultar / Consulter	

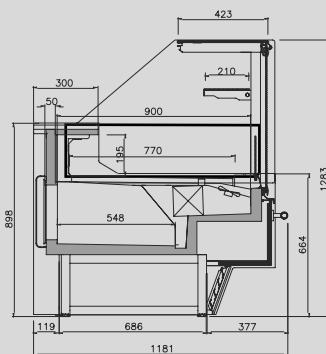



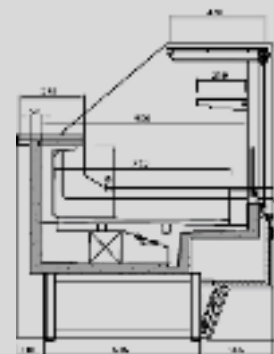



VBC R [con reserva]
[Whit storage]
[Avec réserve]

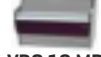
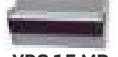

VBC S [Sin reserva]
[Whitout storage]
[Sans réserve]

Vitrina expositora modular frío ventilado grupo remoto /
Refrigerated modular display remote case /
Vitrine présentation froid ventilé canalisable groupe à distance

Mueble caja /
Counter case /
Meuble de comptoir

		CON RESERVA / WHIT STORAGE / AVEC RÉSERVE Rt: Plano Inox / Stainless Steel exhibition plan / Plan d'exposition Inox		MUEBLE CAJA / COUNTER CASE / MEUBLE DE COMPTOIR				
MODELO MODELE MODÈLE								
Precio Price Prix		RCP	IRCP					
MODELO MODELE MODÈLE		SIN RESERVA / WHITOUT STORAGE / SANS RÉSERVE St: Plano Inox / Stainless Steel exhibition plan / Plan d'exposition Inox						
				-	-	-	-	
Precio Price Prix		SCP	ISCP					
Medidas Measures Mesures		(mm)	1887 x 1150 x 1290 mm.	1470 x 1150 x 1290 mm.	938 x 1150 x 906 mm.	1250 x 1150 x 906 mm.	1562 x 1150 x 906 mm.	1250 x 1150 x 906 mm.
Temperatura Temperature Température		(°C)	0°C/+6°C					
Clase Climática Climatic class Classe climatique		(°C)	3 / 25°C					
Tensión/Frecuencia Electrical data Tension électrique			230V/1ph/50Hz					
Controlador Controller Régulateur			Digital					
Material Materiel		[EXT/INT]	Ext: acero plastificado / Plastified stainless steel / Acier plastifié Encimera / Worktop / Dessous: Inox Aisi 304 Plano exposición / Exhibition plan / Plan d'exposition: Acero plastif./ Plastif. Stainless steel/ Acier plastifié [Mod RCP/SCP] - Inox Aisi 304 [Mod. I]					
Aislamiento Isolation Isolation		(mm)	40kg/m ³ / Free CFC's / Zero ODP-GWP					
Capacidad Capacity Capacité		(L)	1,09	1,43	-	-	-	-
Superficie exposición Surface exhibition Surface d'exposition		(m ²)	-	-	0,55	0,74	0,92	-
Compresor Compressor Compresseur		(HP)	-	-	-	-	-	-
Estantes Shelving Étagères			-					
Costados (2) Sides (2) Joues (2)		(mm)	30+30					
Sistema de frío Cooling System Système de froid			Ventilado / Ventilated / Ventilé					
Desescarche Defrost Dégivrage			Automático / Automatic / Automatique					
Evaporación Evaporation Évaporation			Forzada / Forced / Ventilé					
Potencia Power Puissance		(W)	-	-	-	-	-	-
Potencia frig. Cooling capacity Puissance Frig.		(W A -10°C)	1096	1315	-	-	-	-
Consumo Consumption Consommation		(kWh/ 24h)	-	-	-	-	-	-
Refrigerante Refrigerant Gaz			R-290					
Opcional Optional Options			Puertas correderas tras. / Rear sliding doors / Portes couliss. arrière (PUEVBC90ARCT)	Puertas correderas tras. / Rear sliding doors / Portes couliss. arrière (PUEVBC90CRCT)				

Laterales no incluidos en el precio
Side panels not included in price
Joues non incluses dans le prix

Serie / Series / Série **BARCELONA**

+Info: www.infrico.com

Lineal VBC
VBC Linear assembly
Assemblage lineaire VBC



Laterales / Sides / Joues

VBC CP/MP/MHDP: SÍ

Laterales / Sides / Joues

VBC90 AA-AC: NO

Izquierdo Left Gauche	Derecho Right Droite
-----------------------------	----------------------------

Ext. Estándar / Standar / Standard

Blanco/White/ Blanc	Ral 1001	Ral 1018
Ral 2003	Ral 3003	Ral 3020
Design 2108025	Ral 5015	Ral 4007
Ral 6002	Design 1107060	Design 3504035
Ral 9006	Ral 7016	Ral 8017

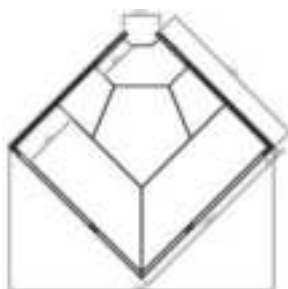

VBC 90 AA RCP/SCP

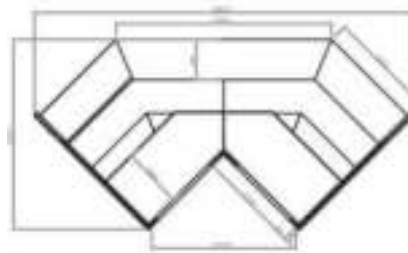

VBC 90 AC RCP/SCP

**Colores fuera de carta /
Colors outside of letter /
Couleurs spéciales, hors palette**

RAL		NO RAL	
Epoxi	Líquida/ Liquid/ Liquide	Epoxi	Líquida/ Liquid/ Liquide
[x unidad/x unit/x unité]		Consultar / Consulter / Consulter	
+10 días laborables / +10 work days / +10 jours ouvrés		Consultar / Consulter / Consulter	

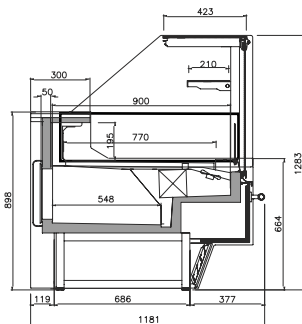

VBC RCP [con reserva]
[Whit storage]
[Avec réserve]

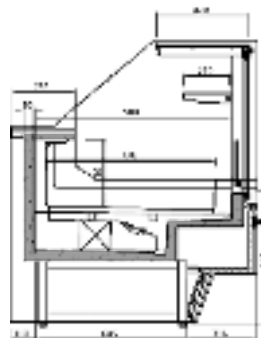



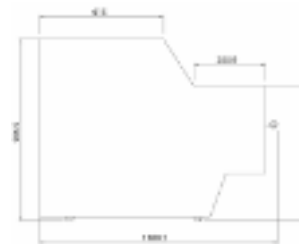







VBC SCP [Sin reserva]
[Whitout storage]
[Sans réserve]



VBC P

Vitrina expositora modular frío ventilado grupo incorporado / Refrigerated modular plugin display case / Vitrine présentation froid ventilé canalisable groupe incorporé

		CURVA / CURVED / BOMBÉE - SIU: Plano Inox / Stainless Steel exhibition plan / Plan d'exposition Inox				
MODELO MODELE MODÈLE						
Precio Price Prix	SUCB SIUCB					
		RECTA / FLAT / DROITE - SIU: Plano Inox / Stainless Steel exhibition plan / Plan d'exposition Inox				
MODELO MODELE MODÈLE						
Precio Price Prix	SUCB CP SIUCB CP					
Medidas Measures Mesures	[mm]	938 x 1181 x 897 mm.	1250 x 1181 x 897 mm.	1562 x 1181 x 897 mm.	1875 x 1181 x 897 mm.	2500 x 1181 x 897 mm.
Temperatura Temperature Température	[°C]	0°C/+6°C				
Clase Climática Climatic class Classe climatique	[°C]	3 / 25°C				
Tensión/Frecuencia Electrical data Tension électrique		230V/1ph/50Hz				
Controlador Controller Régulateur		Digital				
Material Matériel	[EXT/INT]	Ext: acero plastificado / Plastified stainless steel / Acier plastifié Encimera / Worktop / Dessous: Inox Aisi 304 Plano exposición / Exhibition plan / Plan d'exposition: Acero plastif./ Plastif. Stainless steel/ Acier plastifié [Mod SUCB/SUCP] - Inox Aisi 304 [Mod. I]				
Aislamiento Isolation Isolation	[mm]	40kg/m ³ / Free CFC's / Zero ODP-GWP				
Capacidad Capacity Capacité	[L]	108	144	180	217	289
Superficie exposición Surface exhibition Surface d'exposition	[m ²]	0,72	0,96	1,20	1,44	1,93
Compresor Compressor Compresseur	[HP]	1/3	1/2	3/4	3/4	1+1/4
Estantes Shelving Étagères		-				
Costados (2) Sides (2) Joues (2)	[mm]	30+30				
Sistema de frío Cooling System Système de froid		Ventilado / Ventilated / Ventilé				
Desescarche Defrost Dégivrage		Automático / Automatic / Automatique				
Evaporación Evaporation Évaporation		Forzada / Forced / Ventilé				
Potencia Power Puissance	[W]	593	701	816	823	1207
Potencia frig. Cooling capacity Puissance Frig.	[W A -10°C]	-	-	-	-	-
Consumo Consumption Consommation	[kWh/ 24h]	7,10	8,04	9,80	10,1	14,5
Refrigerante Refrigerant Gaz		R-290				
Opcional Optional Options		-				

Laterales no incluidos en el precio
Side panels not included in price
Joues non incluses dans le prix

Serie / Series / Série **BARCELONA**

+Info: www.infrico.com

VBC 15 SUCB



Laterales / Sides / Joues

NO	
Izquierdo Left Gauche	Derecho Right Droite

VBC 15 SUCB CP

Ext. Estándar / Standar / Standard

Blanco/White/ Blanc	Ral 1001	Ral 1018
Ral 2003	Ral 3003	Ral 3020
Design 2108025	Ral 5015	Ral 4007
Ral 6002	Design 1107060	Design 3504035
Ral 9006	Ral 7016	Ral 8017



Cortina nocturna de serie
Standard night curtain
Rideau de nuit de série

Colores fuera de carta /
Colors outside of letter /
Couleurs spéciales, hors palette

RAL		NO RAL	
Epoxi	Líquida/ Liquid/ Liquide	Epoxi	Líquida/ Liquid/ Liquide
[x unidad/x unit/x unité]		Consultar / Consultar / Consulter	
+10 días laborables / +10 work days / +10 jours ouvrés		Consultar / Consultar / Consulter	

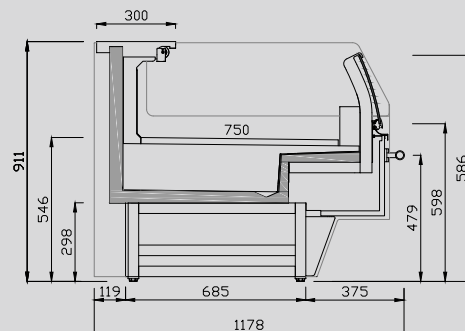



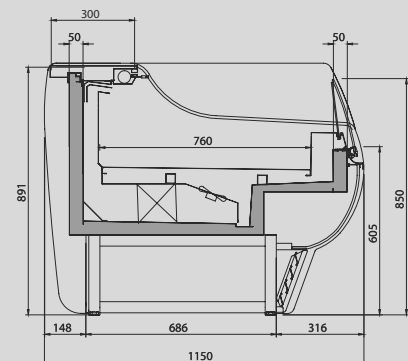







VBC SUCB CP



VBC SUCB

Vitrina expositora modular frío ventilado grupo remoto / Refrigerated modular display remote case / Vitrine présentation froid ventilé canalisable groupe à distance

		CURVA / CURVED / BOMBÉE - SI: Plano Inox / Stainless Steel exhibition plan / Plan d'exposition Inox				
MODELO MODELE MODÈLE						
Precio Price Prix	SCB SICB					
		RECTA / FLAT / DROITE - SI: Plano Inox / Stainless Steel exhibition plan / Plan d'exposition Inox				
MODELO MODELE MODÈLE						
Precio Price Prix	SCB CP SICB CP					
Medidas Measures Mesures	[mm]	938 x 1181 x 897 mm.	1250 x 1181 x 897 mm.	1562 x 1181 x 897 mm.	1875 x 1181 x 897 mm.	2500 x 1181 x 897 mm.
Temperatura Temperature Température	[°C]	0°C/+6°C				
Clase Climática Climatic class Classe climatique	[°C]	3 / 25°C				
Tensión/Frecuencia Electrical data Tension électrique		230V/1ph/50Hz				
Controlador Controller Régulateur		Digital				
Material Matériel	[EXT/INT]	Ext: acero plastificado / Plastified stainless steel / Acier plastifié Encimera / Worktop / Dessous: Inox Aisi 304 Plano exposición / Exhibition plan / Plan d'exposition: Acero plastif./ Plastif. Stainless steel/ Acier plastifié [Mod SCB/SCP] - Inox Aisi 304 [Mod. I]				
Aislamiento Isolation Isolation	[mm]	40kg/m ³ / Free CFC's / Zero ODP-GWP				
Capacidad Capacity Capacité	[L]	108	144	180	217	289
Superficie exposición Surface exhibition Surface d'exposition	[m ²]	0,72	0,96	1,20	1,44	1,93
Compresor Compressor Compresseur	[HP]	-	-	-	-	-
Estantes Shelving Étagères		-				
Costados (2) Sides (2) Joues (2)	[mm]	30+30				
Sistema de frío Cooling System Système de froid		Ventilado / Ventilated / Ventilé				
Desescarche Defrost Dégivrage		Automático / Automatic / Automatique				
Evaporación Evaporation Évaporation		Forzada / Forced / Ventilé				
Potencia Power Puissance	[W]	-	-	-	-	-
Potencia frig. Cooling capacity Puissance Frig.	[W A -10°C]	817	1096	1315	1506	2009
Consumo Consumption Consommation	[kWh/ 24h]	-	-	-	-	-
Refrigerante Refrigerant Gaz		R-290				
Opcional Optional Options		-				

Laterales no incluidos en el precio
Side panels not included in price
Joues non incluses dans le prix

Serie / Series / Série **BARCELONA**

+Info: www.infrico.com

VBC 15 SCB CP



Laterales / Sides / Joutes

NO	
Izquierdo Left Gauche	Derecho Right Droite



VBC 15 SCB

Ext. Estándar / Standar / Standard

Blanco/White/ Blanc	Ral 1001	Ral 1018
Ral 2003	Ral 3003	Ral 3020
Design 2108025	Ral 5015	Ral 4007
Ral 6002	Design 1107060	Design 3504035
Ral 9006	Ral 7016	Ral 8017



Cortina nocturna de serie
Standard night curtain
Rideau de nuit de série

Colores fuera de carta /
Colors outside of letter /
Couleurs spéciales, hors palette

RAL		NO RAL	
Epoxi	Líquida/ Liquid/ Liquide	Epoxi	Líquida/ Liquid/ Liquide
[x unidad/x unit/x unité]		Consultar / Consulter / Consulter	
+10 días laborables / +10 work days / +10 jours ouvrés		Consultar / Consulter / Consulter	

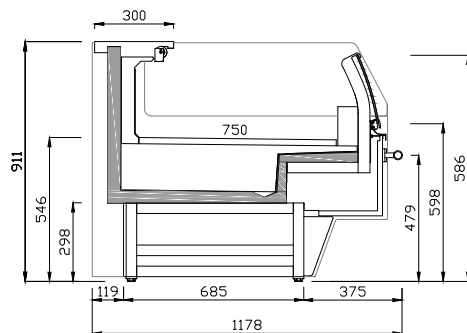

VBC SCB CP

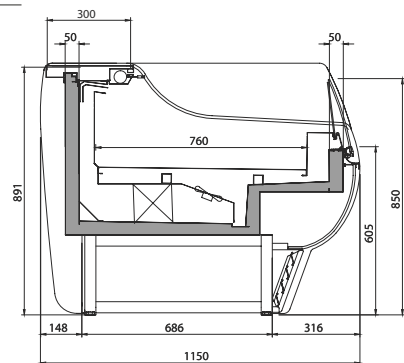















VBC SCB



+Info: www.infrico.com



Vitrina expositora modular frío ventilado grupo incorporado / Refrigerated modular plugin display case / Vitrine présentation froid ventilé canalisable groupe incorporé

		CRISTAL CURVO CON RESERVA / CURVED GLASS WITH STORAGE / VITRE BOMBÉE AVEC RÉSERVE						
MODELO MODELE MODÈLE								
Precio Price Prix	RU RIU							
		CRISTAL RECTO CON RESERVA / FLAT GLASS WITH STORAGE / VITRE DROITE AVEC RÉSERVE						
MODELO MODELE MODÈLE								
Precio Price Prix	RUCP RIUCP							
Medidas Measures Mesures	(mm)	938 x 1285 x 1310 mm.	1250 x 1285 x 1310 mm.	1562 x 1285 x 1310 mm.	1875 x 1285 x 1310 mm.	2500 x 1285 x 1310 mm.	3125 x 1285 x 1310 mm.	3750 x 1285 x 1310 mm.
Temperatura Temperature Température	(°C)	0°C/+6°C						
Clase Climática Climatic class Classe climatique	(°C)	3 / 25°C						
Tensión/Frecuencia Electrical data Tension électrique		230V/1ph/50Hz						
Controlador Controller Régulateur		Digital						
Material Matériel	[EXT/INT]	Ext: acero plastificado / Plastified stainless steel / Acier plastifié Encimera / Worktop / Dessous: Inox Aisi 304 Plano exposición / Exhibition plan / Plan d'exposition: Acero plastif./ Plastif. Stainless steel/ Acier plastifié [Mod RU/RUCP] - Inox Aisi 304 [Mod. I]						
Aislamiento Isolation Isolation	(mm)	40kg/m ³ / Free CFC's / Zero ODP-GWP						
Capacidad Capacity Capacité	(L)	129	172	214	257	343	429	515
Superficie exposición Surface exhibition Surface d'exposition	(m ²)	0,86	1,14	1,43	1,72	2,29	2,86	3,43
Compresor Compressor Compresseur	(HP)	1/3	1/2	3/4	3-4	1+1/4	1+1/4	1+1/4
Estantes Shelving Étagères		-						
Costados (2) Sides (2) Joues (2)	(mm)	40+40						
Sistema de frío Cooling System Système de froid		Ventilado / Ventilated / Ventilé						
Desescarche Defrost Dégivrage		Automático / Automatic / Automatique						
Evaporación Evaporation Évaporation		Forzada / Forced / Ventilé						
Potencia Power Puissance	(W)	416	567	634	733	1176	2242	2280
Potencia frig. Cooling capacity Puissance Frig.	(W A -10°C)	-	-	-	-	-	-	-
Consumo Consumption Consommation	(kWh/ 24h)	5,50	7,40	8,30	9,70	15,5	29,6	30,1
Refrigerante Refrigerant Gaz		R-290						
		Puertas correderas traseras / Rear sliding doors / Portes coulissantes arrière						
Opcional Optional Options	R (PUEVEU9CT)	R (PUEVEU12CT)	R (PUEVEU15CT)	R (PUEVEU18CT)	R (PUEVEU25CT)	R (PUEVEU31CT)	R (PUEVEU37CT)	
	P (PUEVEU9CTCP)	P (PUEVEU12CTCP)	P (PUEVEU15CTCP)	P (PUEVEU18CTCP)	P (PUEVEU25CTCP)	P (PUEVEU31CTCP)	P (PUEVEU37CTCP)	
	Cortinas traseras nocturnas / Night curtains / Rideaux de nuit							
	(CCNV9)	(CCNV12)	(CCNV15)	(CCNV18)	(CCNV25)	(CCNV31)	(CCNV37)	
		Cristal calefactado curvo / Heated curved frontal glass / Vitre bombée chauffée						
	R	R	R	R	R	R	R	R
	(CRCCTVEU9)	(CRCCTVEU12)	(CRCCTVEU15)	(CRCCTVEU18)	(CRCCTVEU25)	(CRCCTVEU31)	(CRCCTVEU37)	

R: CRISTAL CURVO / CURVED GLASS / VITRE BOMBÉE
P: CRISTAL RECTO / FLAT GLASS / VITRE DROITE

Laterales no incluidos en el precio
Side panels not included in price
Joues non incluses dans le prix

Serie / Series / Série **EUROPA**

+Info: www.infrico.com

VEU 18 RU



Laterales / Sides / Joues

NO	
Izquierdo Left Gauche	Derecho Right Droite
CP:	CP:



VEU 18 RUCP

Ext. Estándar / Standar / Standard

Blanco/White/ Blanc	Ral 1001	Ral 1018
Ral 2003	Ral 3003	Ral 3020
Design 2108025	Ral 5015	Ral 4007
Ral 6002	Design 1107060	Design 3504035
Ral 9006	Ral 7016	Ral 8017

**Colores fuera de carta /
Colors outside of letter /
Couleurs spéciales, hors palette**

RAL		NO RAL	
Epoxi	Líquida/ Liquid/ Liquide	Epoxi	Líquida/ Liquid/ Liquide
[x unidad/x unit/x unité]		Consultar / Consulter / Consulter	
+10 días laborables / +10 work days / +10 jours ouvrés		Consultar / Consulter / Consulter	

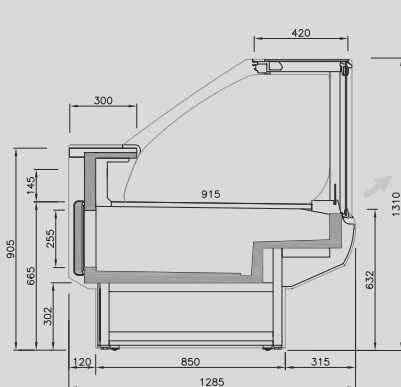



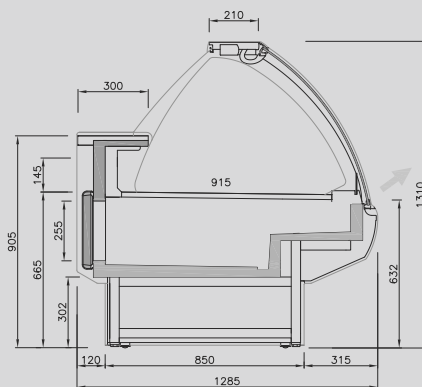











**VEU RUCP [con reserva]
[Whit storage]
[Avec réserve]**



**VEU RU [Con reserva]
[Whit storage]
[Avec réserve]**

Vitrina expositora modular frío ventilado grupo remoto / Refrigerated modular display remote case / Vitrine présentation froid ventilé canalisable groupe à distance

		CRISTAL CURVO CON RESERVA / CURVED GLASS WITH STORAGE / VITRE BOMBÉE AVEC RÉSERVE						
MODELO MODELE MODÈLE								
Precio Price Prix	R RI							
		CRISTAL RECTO CON RESERVA / FLAT GLASS WITH STORAGE / VITRE DROITE AVEC RÉSERVE						
MODELO MODELE MODÈLE								
Precio Price Prix	RCP RICP							
Medidas Mesures Mesures	(mm)	938 x 1285 x 1310 mm.	1250 x 1285 x 1310 mm.	1562 x 1285 x 1310 mm.	1875 x 1285 x 1310 mm.	2500 x 1285 x 1310 mm.	3125 x 1285 x 1310 mm.	3750 x 1285 x 1310 mm.
Temperatura Temperature Température	(°C)	0°C/+6°C						
Clase Climática Climatic class Classe climatique	(°C)	3 / 25°C						
Tensión/Frecuencia Electrical data Tension électrique		230V/1ph/50Hz						
Controlador Controller Régulateur		Digital						
Material Matériel Matériel	(EXT/INT)	Ext: acero plastificado / Plastified stainless steel / Acier plastifié Encimera / Worktop / Dessous: Inox Aisi 304 Plano exposición / Exhibition plan / Plan d'exposition: Acero plastif./ Plastif. Stainless steel/ Acier plastifié (Mod R/RCP) - Inox Aisi 304 (Mod. I)						
Aislamiento Isolation Isolation	(mm)	40kg/m ³ / Free CFC's / Zero ODP-GWP						
Capacidad Capacity Capacité	(L)	129	172	214	257	343	429	515
Superficie exposición Surface exhibition Surface d'exposition	(m ²)	0,86	1,14	1,43	1,72	2,29	2,86	3,43
Compresor Compressor Compresseur	(HP)	-	-	-	-	-	-	-
Estantes Shelving Étagères		-						
Costados (2) Sides (2) Joues (2)	(mm)	40+40						
Sistema de frío Cooling System Système de froid		Ventilado / Ventilated / Ventilé						
Desescarche Defrost Dégivrage		Automático / Automatic / Automatique						
Evaporación Evaporation Evaporation		Forzada / Forced / Ventilé						
Potencia Power Puissance	(W)	-	-	-	-	-	-	-
Potencia frig. Cooling capacity Puissance Frig.	(W A -10°C)	704	938	1172	1406	1875	2344	2813
Consumo Consumption Consommation	(kWh/ 24h)	-	-	-	-	-	-	-
Refrigerante Refrigerant Gaz		R-290						
		Puertas correderas traseras / Rear sliding doors / Portes coulissantes arrière						
Opcional Optional Options	R (PUEVEU9CT)	R (PUEVEU12CT)	R (PUEVEU15CT)	R (PUEVEU18CT)	R (PUEVEU25CT)	R (PUEVEU31CT)	R (PUEVEU37CT)	
	P (PUEVEU9CTCP)	P (PUEVEU12CTCP)	P (PUEVEU15CTCP)	P (PUEVEU18CTCP)	P (PUEVEU25CTCP)	P (PUEVEU31CTCP)	P (PUEVEU37CTCP)	
	Cortinas traseras nocturnas / Night curtains / Rideaux de nuit							
	(CCNV9)	(CCNV12)	(CCNV15)	(CCNV18)	(CCNV25)	(CCNV31)	(CCNV37)	
		Cristal calefactado curvo / Heated curved frontal glass / Vitre bombée chauffée						
	R	R	R	R	R	R	R	
	(CRCCTVEU9)	(CRCCTVEU12)	(CRCCTVEU15)	(CRCCTVEU18)	(CRCCTVEU25)	(CRCCTVEU31)	(CRCCTVEU37)	

R: CRISTAL CURVO / CURVED GLASS / VITRE BOMBÉE
P: CRISTAL RECTO / FLAT GLASS / VITRE DROITE

Laterales no incluidos en el precio
Side panels not included in price
Joues non incluses dans le prix

Serie / Series / Série **EUROPA**

+Info: www.infrico.com

VEU 18 RICP



Laterales / Sides / Joues

NO	
Izquierdo Left Gauche	Derecho Right Droite
CP:	CP:

Ext. Estándar / Standar / Standard

Blanco/White/ Blanc	Ral 1001	Ral 1018
Ral 2003	Ral 3003	Ral 3020
Design 2108025	Ral 5015	Ral 4007
Ral 6002	Design 1107060	Design 3504035
Ral 9006	Ral 7016	Ral 8017

Colores fuera de carta /
Colors outside of letter /
Couleurs spéciales, hors palette

RAL		NO RAL	
Epoxi	Líquida/ Liquid/ Liquide	Epoxi	Líquida/ Liquid/ Liquide
[x unidad/x unit/x unité]		Consultar / Consulter / Consulter	
+10 días laborables / +10 work days / +10 jours ouvrés		Consultar / Consulter / Consulter	

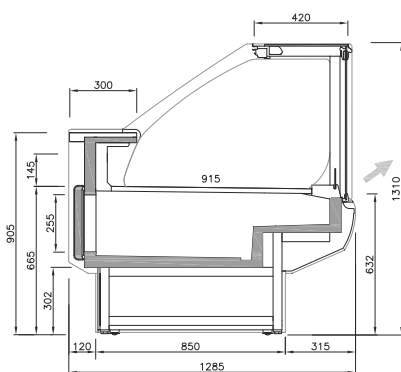



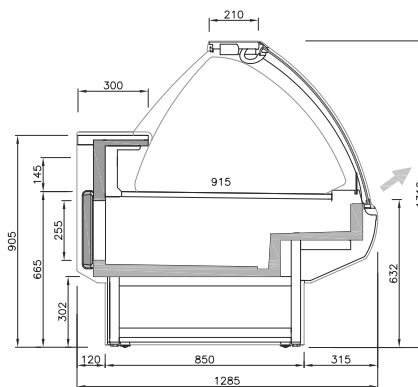











VEU RCP/RICP [con reserva]
[Whit storage]
[Avec réserve]



VEU R/RI [Con reserva]
[Whit storage]
[Avec réserve]

Vitrina expositora modular frío ventilado sin reserva grupo incorporado / Refrigerated without storage modular plugin display case / Vitrine présentation froid ventilé canalisable sans réserve groupe incorporé

		CRISTAL CURVO SIN RESERVA / CURVED GLASS WITHOUT STORAGE / VITRE BOMBÉE SANS RÉSERVE						
MODELO MODELE MODÈLE								
Precio Price Prix	SU SIU							
		CRISTAL RECTO SIN RESERVA / FLAT GLASS WITHOUT STORAGE / VITRE DROITE SANS RÉSERVE						
MODELO MODELE MODÈLE								
Precio Price Prix	SUCP SIUCP							
Medidas Measures Mesures	(mm)	938 x 1285 x 1310 mm.	1250 x 1285 x 1310 mm.	1562 x 1285 x 1310 mm.	1875 x 1285 x 1310 mm.	2500 x 1285 x 1310 mm.	3125 x 1285 x 1310 mm.	3750 x 1285 x 1310 mm.
Temperatura Temperature Température	(°C)	0°C/+6°C						
Clase Climática Climatic class Classe climatique	(°C)	3 / 25°C						
Tensión/Frecuencia Electrical data Tension électrique		230V/1ph/50Hz						
Controlador Controller Régulateur		Digital						
Material Matériel	[EXT/INT]	Ext: acero plastificado / Plastified stainless steel / Acier plastifié Encimera / Worktop / Dessous: Inox Aisi 304 Plano exposición / Exhibition plan / Plan d'exposition: Acero plastif./ Plastif. Stainless steel/ Acier plastifié (Mod SU/SUCP) - Inox Aisi 304 (Mod. I)						
Aislamiento Isolation Isolation	(mm)	40kg/m ³ / Free CFC's / Zero ODP-GWP						
Capacidad Capacity Capacité	(L)	172	229	286	343	458	572	686
Superficie exposición Surface exhibition Surface d'exposition	(m ²)	0,86	1,14	1,43	1,72	2,29	2,86	3,43
Compresor Compressor Compresseur	(HP)	1/3	1/2	3/4	3/4	1+1/4	1+1/4	1+1/4
Costados (2) Sides (2) Joues (2)	(mm)	40+40						
Sistema de frío Cooling System Système de froid		Ventilado / Ventilated / Ventilé						
Desescarche Defrost Dégivrage		Automático / Automatic / Automatique						
Evaporación Evaporation Évaporation		Forzada / Forced / Ventilé						
Potencia Power Puissance	(W)	416	567	634	733	1176	2242	2280
Potencia frig. Cooling capacity Puissance Frig.	(W A -10°C)	676	1096	1315	1506	2009	2600	3000
Consumo Consumption Consommation	(kWh/ 24h)	5,5	7,4	8,3	9,7	15,5	29,6	30,1
Refrigerante Refrigerant Gaz		R-290						
Opcional Optional Options	Puertas correderas traseras / Rear sliding doors / Portes coulissantes arrière							
	R (PUEVEU9CT)	R (PUEVEU12CT)	R (PUEVEU15CT)	R (PUEVEU18CT)	R (PUEVEU25CT)	R (PUEVEU31CT)	R (PUEVEU37CT)	
	P (PUEVEU9CTCP)	P (PUEVEU12CTCP)	P (PUEVEU15CTCP)	P (PUEVEU18CTCP)	P (PUEVEU25CTCP)	P (PUEVEU31CTCP)	P (PUEVEU37CTCP)	
	Cortinas traseras nocturnas / Night curtains / Rideaux de nuit							
	[CCNV9]	[CCNV12]	[CCNV15]	[CCNV18]	[CCNV25]	[CCNV31]	[CCNV37]	
	Doble plano [sin reserva] / Double surface [without storage] / Double plan [sans réserve] - Modelo/Model/Modèle I: Inox							
	[DPEXVEU9S] [DPEXVEU9SI]	[DPEXVEU12S] [DPEXVEU12SI]	[DPEXVEU15S] [DPEXVEU15SI]	[DPEXVEU18S] [DPEXVEU18SI]	[DPEXVEU25S] [DPEXVEU25SI]	[DPEXVEU31S] [DPEXVEU31SI]	[DPEXVEU37S] [DPEXVEU37SI]	
Cristal calefactado curvo / Heated curved frontal glass / Vitre bombée chauffée								
[CRCCTVEU9]	[CRCCTVEU12]	[CRCCTVEU15]	[CRCCTVEU18]	[CRCCTVEU25]	[CRCCTVEU31]	[CRCCTVEU37]		

R: CRISTAL CURVO / CURVED GLASS / VITRE BOMBÉE
P: CRISTAL RECTO / FLAT GLASS / VITRE DROITE

Laterales no incluidos en el precio
Side panels not included in price
Joues non incluses dans le prix

Serie / Series / Série **EUROPA**

+Info: www.infrico.com

VEU 18 SU



Laterales / Sides / Joues

NO	
Izquierdo Left Gauche	Derecho Right Droite
CP:	CP:

Ext. Estándar / Standar / Standard

Blanco/White/ Blanc	Ral 1001	Ral 1018
Ral 2003	Ral 3003	Ral 3020
Design 2108025	Ral 5015	Ral 4007
Ral 6002	Design 1107060	Design 3504035
Ral 9006	Ral 7016	Ral 8017

**Colores fuera de carta /
Colors outside of letter /
Couleurs spéciales, hors palette**

RAL		NO RAL	
Epoxi	Líquida/ Liquid/ Liquide	Epoxi	Líquida/ Liquid/ Liquide
[x unidad/x unit/x unité]		Consultar / Consulter / Consulter	
+10 días laborables / +10 work days / +10 jours ouvrés		Consultar / Consulter / Consulter	

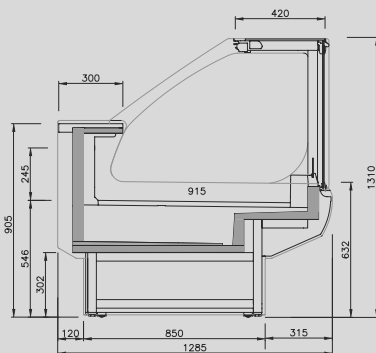



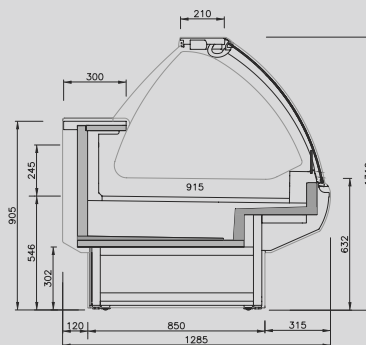











**VEU SUCP (Sin reserva)
(Whitout storage)
(Sans réserve)**



**VEU SU (Sin reserva)
(Whitout storage)
(Sans réserve)**

Vitrina expositora modular frío ventilado sin reserva grupo remoto / Refrigerated without storage modular display remote case / Vitrine présentation froid ventilé canalisable sans réserve groupe à distance

CRISTAL CURVO SIN RESERVA / CURVED GLASS WITHOUT STORAGE / VITRE BOMBÉE SANS RÉSERVE

MODELO MODELE MODÈLE							
Precio Price Prix	S						
	SI						
MODELO MODELE MODÈLE							
Precio Price Prix	SCP						
	SICP						
Medidas Measures Mesures	(mm) 938 x 1285 x 1310 mm.	(mm) 1250 x 1285 x 1310 mm.	(mm) 1562 x 1285 x 1310 mm.	(mm) 1875 x 1285 x 1310 mm.	(mm) 2500 x 1285 x 1310 mm.	(mm) 3125 x 1285 x 1310 mm.	(mm) 3750 x 1285 x 1310 mm.
Temperatura Temperature Température	°C/+6°C						
Clase Climática Climatic class Classe climatique	3 / 25°C						
Tensión/Frecuencia Electrical data Tension électrique	230V/1ph/50Hz						
Controlador Controller Régulateur	Digital						
Material Matériel	[EXT/INT] Ext: acero plastificado / Plastified stainless steel / Acier plastifié Encimera / Worktop / Dessous: Inox Aisi 304 Plano exposición / Exhibition plan / Plan d'exposition: Acero plastif./Plastif. Stainless steel/ Acier plastifié (Mod S/SCP) - Inox Aisi 304 (Mod. I)						
Aislamiento Isolation Isolation	(mm) 40kg/m ³ / Free CFC's / Zero ODP-GWP						
Capacidad Capacity Capacité	(L) 172	(L) 229	(L) 286	(L) 343	(L) 458	(L) 572	(L) 686
Superficie exposición Surface exhibition Surface d'exposition	(m ²) 0,86	(m ²) 1,14	(m ²) 1,43	(m ²) 1,72	(m ²) 2,29	(m ²) 2,86	(m ²) 3,43
Compresor Compressor Compresseur	(HP) -	(HP) -	(HP) -	(HP) -	(HP) -	(HP) -	(HP) -
Costados [2] Sides [2] Joues [2]	(mm) 40+40						
Sistema de frío Cooling System Système de froid	Ventilado / Ventilated / Ventilé						
Desescarche Defrost Dégivrage	Automático / Automatic / Automatique						
Evaporación Evaporation Évaporation	Forzada / Forced / Ventilé						
Potencia Power Puissance	(W) -	(W) -	(W) -	(W) -	(W) -	(W) -	(W) -
Potencia frig. Cooling capacity Puissance Frig.	(W A -10°C) 676	(W A -10°C) 1096	(W A -10°C) 1315	(W A -10°C) 1506	(W A -10°C) 2009	(W A -10°C) 2600	(W A -10°C) 3000
Consumo Consumption Consommation	(kWh/24h) -	(kWh/24h) -	(kWh/24h) -	(kWh/24h) -	(kWh/24h) -	(kWh/24h) -	(kWh/24h) -
Refrigerante Refrigerant Gaz	R-290						
Opcional Optional Options	Puertas correderas traseras / Rear sliding doors / Portes coulissantes arrière						
	R (PUEVEU9CT)	R (PUEVEU12CT)	R (PUEVEU15CT)	R (PUEVEU18CT)	R (PUEVEU25CT)	R (PUEVEU31CT)	R (PUEVEU37CT)
	P (PUEVEU9CTCP)	P (PUEVEU12CTCP)	P (PUEVEU15CTCP)	P (PUEVEU18CTCP)	P (PUEVEU25CTCP)	P (PUEVEU31CTCP)	P (PUEVEU37CTCP)
	Cortinas traseras nocturnas / Night curtains / Rideaux de nuit						
	[CCNV9]	[CCNV12]	[CCNV15]	[CCNV18]	[CCNV25]	[CCNV31]	[CCNV37]
	Doble plano [sin reserva] / Double surface [without storage] / Double plan [sans réserve] - Modelo/Model/Modèle I: Inox						
	[DPEXVEU9S] [DPEXVEU9SI]	[DPEXVEU12S] [DPEXVEU12SI]	[DPEXVEU15S] [DPEXVEU15SI]	[DPEXVEU18S] [DPEXVEU18SI]	[DPEXVEU25S] [DPEXVEU25SI]	[DPEXVEU31S] [DPEXVEU31SI]	[DPEXVEU37S] [DPEXVEU37SI]
Crystal calefactado curvo / Heated curved frontal glass / Vitre bombée chauffée							
[CRCCTVEU9]	[CRCCTVEU12]	[CRCCTVEU15]	[CRCCTVEU18]	[CRCCTVEU25]	[CRCCTVEU31]	[CRCCTVEU37]	

R: CRISTAL CURVO / CURVED GLASS / VITRE BOMBÉE
P: CRISTAL RECTO / FLAT GLASS / VITRE DROITE

Laterales no incluidos en el precio
Side panels not included in price
Joues non incluses dans le prix

Serie / Series / Série **EUROPA**

+Info: www.infrico.com

VEU 18 SICP



Laterales / Sides / Joues

NO	
Izquierdo Left Gauche	Derecho Right Droite
CP:	CP:



Ext. Estándar / Standar / Standard

Blanco/White/ Blanc	Ral 1001	Ral 1018
Ral 2003	Ral 3003	Ral 3020
Design 2108025	Ral 5015	Ral 4007
Ral 6002	Design 1107060	Design 3504035
Ral 9006	Ral 7016	Ral 8017

VEU 18 SI

**Colores fuera de carta /
Colors outside of letter /
Couleurs spéciales, hors palette**

RAL		NO RAL	
Epoxi	Líquida/ Liquid/ Liquide	Epoxi	Líquida/ Liquid/ Liquide
[x unidad/x unit/x unité]		Consultar / Consulter / Consulter	
+10 días laborables / +10 work days / +10 jours ouvrés		Consultar / Consulter / Consulter	

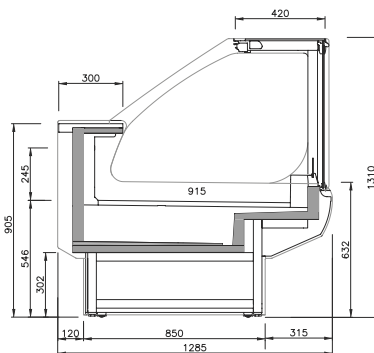



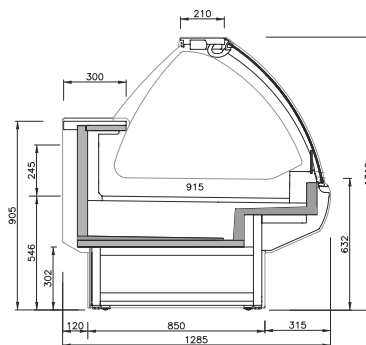









**VEU SCP (Sin reserva)
[Whitout storage]
[Sans réserve]**



**VEU S (Sin reserva)
[Whitout storage]
[Sans réserve]**

Vitrina expositora modular frío ventilado, con y sin reserva / Refrigerated modular display case, with and without reserve / Vitrine présentation froid ventilé canalisable, avec et sans réserve

		CON RESERVA / WHIT STORAGE / AVEC RÉSERVE					
MODELO MODELE MODÈLE							
Precio Price Prix	RU RIU						
		SIN RESERVA / WHITOUT STORAGE / SANS RÉSERVE					
MODELO MODELE MODÈLE							
Precio Price Prix	SU SIU						
Medidas Measures Mesures	(mm)	1326 x 1285 x 1310 mm.	1108 x 1285 x 1310 mm.	1887 x 1285 x 1310 mm.	1285 x 1150 x 1310 mm.	1285 x 1150 x 1310 mm.	1887 x 1285 x 1310 mm.
Temperatura Temperature Température	(°C)	0°C/+6°C					
Clase Climática Climatic class Classe climatique	(°C)	3 / 25°C					
Tensión/Frecuencia Electrical data Tension électrique		230V/1ph/50Hz					
Controlador Controller Régulateur		Digital					
Material Matériel	[EXT/INT]	Ext: acero plastificado / Plastified stainless steel / Acier plastifié Encimera / Worktop / Dessous: Inox Aisi 304 Plano exposición / Exhibition plan / Plan d'exposition: Acero plastif./ Plastif. Stainless steel/ Acier plastifié (Mod RU/SU-RN/SN) - Inox Aisi 304 (Mod. I)					
Aislamiento Isolation Isolation	(mm)	40kg/m ³ / Free CFC's / Zero ODP-GWP					
Capacidad Capacity Capacité	(L)	-					
Superficie exposición Surface exhibition Surface d'exposition	(m ²)	1,10	0,60	1,85	0,92	1,10	1,85
Compresor Compressor Compresseur	(HP)	1/2	-	3/4	1/2	1/2	3/4
Estantes Shelving Étagères		1 [+ 1 OPCIONAL/OPTIONAL/OPTION]					
Costados (2) Sides (2) Joues (2)	(mm)	40+40					
Sistema de frío Cooling System Système de froid		Ventilado / Ventilated / Ventilé					
Desescarche Defrost Dégivrage		Automático / Automatic / Automatique					
Evaporación Evaporation Évaporation		Forzada / Forced / Ventilé					
Potencia Power Puissance	(W)	1025	35	1110	780	1025	1110
Potencia frig. Cooling capacity Puissance Frig.	(W A -10°C)	-	-	-	-	-	-
Consumo Consumption Consommation	(kWh/ 24h)	14,4	0,5	15,5	10,9	14,4	10,9
Refrigerante Refrigerant Gaz		R-290					
		Puertas correderas traseras / Rear sliding doors / Portes couliss. arrière					
Opcional Optional Options		(PUEVEU90AACT)	(PUEVEU45AACT)	(PUEVEU90ACCT)	(PUEVEU45ACCT)	(PUEVEU90AACTCP)	(PUEVEU90ACCTCP)
		Doble plano (sin reserva) / Double surface (without storage) / Double plan (sans réserve) - Modelo/Model/Modèle I: Inox					
		(DPEXVEU90AAS) (DPEXVEU90AASI)	(DPEXVEU45AAS) (DPEXVEU45AASI)	(DPEXVEU90ACS) (DPEXVEU90ACSI)	(DPEXVEU45ACS) (DPEXVEU45ACSI)	-	-

Laterales no incluidos en el precio
Side panels not included in price
Joues non inclus dans le prix

Serie / Series / Série **EUROPA**

+Info: www.infrico.com

Lineal VEU
VEU Linear assembly
Assemblage lineaire VEU



VEU 90 AA RU
VEU 90 AA SU

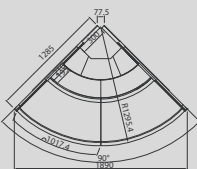

VEU 45 AA RN
VEU 45 AA SN

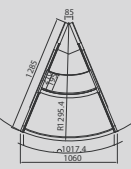

VEU 90 AC RU
VEU 90 AC SU

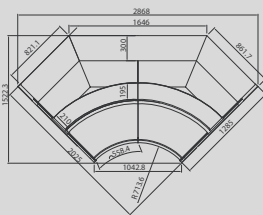

VEU 45 AC RU
VEU 45 AC SU

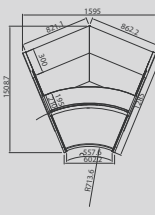

VEU 90 C RUCP
VEU 90 C SUCP

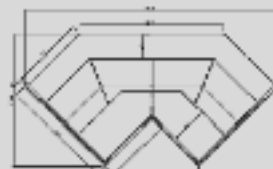

VEU 90 A RUCP
VEU 90 A SUCP

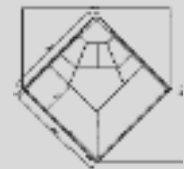

Laterales / Sides / Joues

NO	
Izquierdo Left Gauche	Derecho Right Droite
CP:	CP:

Ext. Estándar / Standar / Standard

Blanco/White/ Blanc	Ral 1001	Ral 1018
Ral 2003	Ral 3003	Ral 3020
Design 2108025	Ral 5015	Ral 4007
Ral 6002	Design 1107060	Design 3504035
Ral 9006	Ral 7016	Ral 8017

**Colores fuera de carta /
Colors outside of letter /
Couleurs spéciales, hors palette**

RAL		NO RAL	
Epoxi	Líquida/ Liquid/ Liquide	Epoxi	Líquida/ Liquid/ Liquide
[x unidad/x unit/x unité]		Consultar / Consulter / Consulter	
+10 días laborables / +10 work days / +10 jours ouvrés		Consultar / Consulter / Consulter	

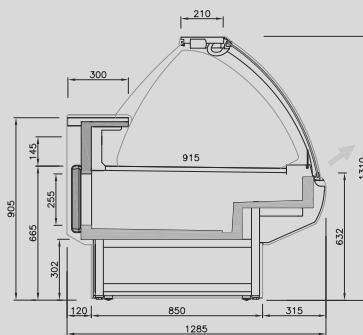

VEU RU (Con reserva)
[Whit storage]
[Avec réserve]

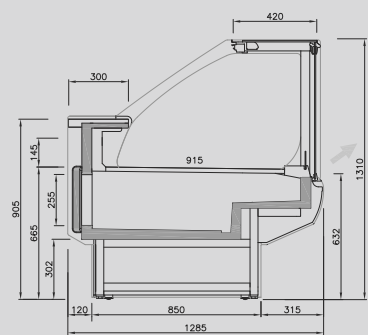

VEU RUCP (con reserva)
[Whit storage]
[Avec réserve]

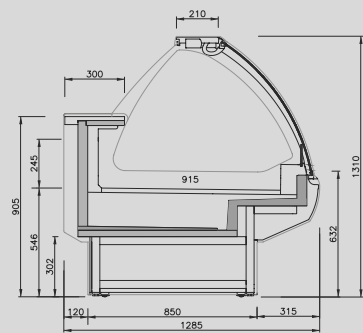



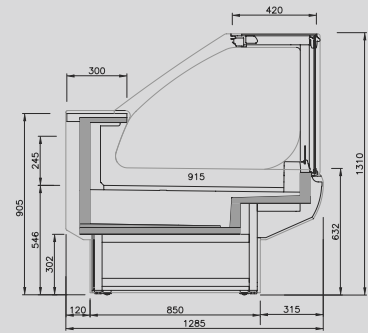









VEU SU (Sin reserva)
[Whitout storage]
[Sans réserve]



VEU SUCP (Sin reserva)
[Whitout storage]
[Sans réserve]

Vitrina expositora modular frío ventilado, con y sin reserva, grupo remoto / Refrigerated modular display remote case, with and without reserve / Vitrine présentation froid ventilé canalisable, avec et sans réserve, groupe à distance

		CON RESERVA / WHIT STORAGE / AVEC RÉSERVE					
MODELO MODELE MODÈLE							
Precio Price Prix	R RI						
		SIN RESERVA / WHITOUT STORAGE / SANS RÉSERVE					
MODELO MODELE MODÈLE							
Precio Price Prix	S SI						
Medidas Measures Mesures	(mm)	1326 x 1285 x 1310 mm.	1108 x 1285 x 1310 mm.	1887 x 1285 x 1310 mm.	1285 x 1150 x 1310 mm.	1285 x 1150 x 1310 mm.	1887 x 1285 x 1310 mm.
Temperatura Temperature Température	(°C)	0°C/+6°C					
Clase Climática Climatic class Classe climatique	(°C)	3 / 25°C					
Tensión/Frecuencia Electrical data Tension électrique		230V/1ph/50Hz					
Controlador Controller Régulateur		Digital					
Material Matériel	(EXT/INT)	Ext: acero plastificado / Plastified stainless steel / Acier plastifié Encimera / Worktop / Dessus: Inox Aisl 304 Plano exposición / Exhibition plan / Plan d'exposition: acero plastificado / Plastified stainless steel / Acier plastifié					
Aislamiento Isolation Isolation	(mm)	40kg/m ³ / Free CFC's / Zero ODP-GWP					
Capacidad Capacity Capacité	(L)	-					
Superficie exposición Surface exhibition Surface d'exposition	(m ²)	1,10	0,60	1,85	0,92	1,10	1,85
Compresor Compressor Compresseur	(HP)	-	-	-	-	-	-
Estantes Shelving Étagères		1 [+ 1 OPCIONAL/OPTIONAL/OPTION]					
Costados (2) Sides (2) Joues (2)	(mm)	40+40					
Sistema de frío Cooling System Système de froid		Ventilado / Ventilated / Ventilé					
Desescarche Defrost Dégivrage		Automático / Automatic / Automatique					
Evaporación Evaporation Évaporation		Forzada / Forced / Ventilé					
Potencia Power Puissance	(W)	-	-	-	-	-	-
Potencia frig. Cooling capacity Puissance Frig.	(W A -10°C)	817	-	1315	817	817	1315
Consumo Consumption Consommation	(kWh/ 24h)	-	-	-	-	-	-
Refrigerante Refrigerant Gaz		R-290					
		Puertas correderas traseras / Rear sliding doors / Portes couliss. arrière					
Opcional Optional Options		(PUEVEU90AACT)	(PUEVEU45AACT)	(PUEVEU90ACCT)	(PUEVEU45ACCT)	(PUEVEU90AACTCP)	(PUEVEU90ACCTCP)
		Doble plano (sin reserva) / Double surface (without storage) / Double plan (sans réserve) - Modelo/Model/Modèle I: Inox					
		(DPEXVEU90AAS)	(DPEXVEU45AAS)	(DPEXVEU90ACS)	(DPEXVEU45ACS)	-	-
		(DPEXVEU90AASI)	(DPEXVEU45AASI)	(DPEXVEU90ACSI)	(DPEXVEU45ACSI)	-	-

Laterales no incluidos en el precio
Side panels not included in price
Joues non incluses dans le prix

+Info: www.infrico.com

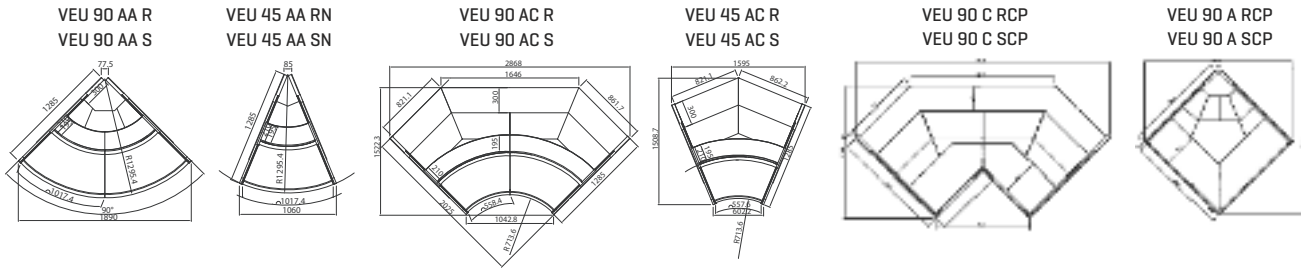

Lineal VEU
VEU Linear assembly
Assemblage lineaire VEU



Laterales / Sides / Joues

NO	
Izquierdo Left Gauche	Derecho Right Droite
CP:	CP:

Ext. Estándar / Standar / Standard

Blanco/White/ Blanc	Ral 1001	Ral 1018
Ral 2003	Ral 3003	Ral 3020
Design 2108025	Ral 5015	Ral 4007
Ral 6002	Design 1107060	Design 3504035
Ral 9006	Ral 7016	Ral 8017

**Colores fuera de carta /
Colors outside of letter /
Couleurs spéciales, hors palette**

RAL		NO RAL	
Epoxi	Líquida/ Liquid/ Liquide	Epoxi	Líquida/ Liquid/ Liquide
[x unidad/x unit/x unité]		Consultar / Consultar / Consulter	
+10 días laborables / +10 work days / +10 jours ouvrés		Consultar / Consultar / Consulter	

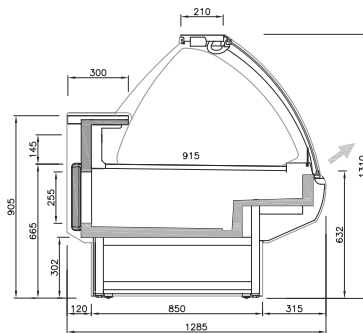

VEU R [Con reserva]
[Whit storage]
[Avec réserve]

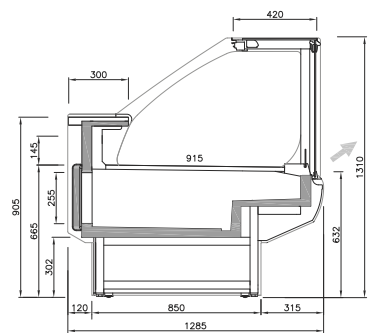

VEU RCP [con reserva]
[Whit storage]
[Avec réserve]

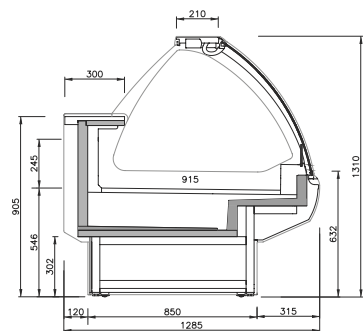



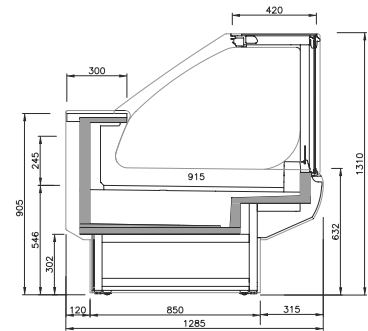





VEU S [Sin reserva]
[Whitout storage]
[Sans réserve]



VEU SCP [Sin reserva]
[Whitout storage]
[Sans réserve]

Vitrina expositora modular frío ventilado autoservicio /
Refrigerated self service modular display case /
Vitrine présentation froid ventilé libre service canalisable

Mueble caja /
Counter case /
Meuble caisse

MODELO MODELE MODÈLE						MUEBLE CAJA / COUNTER CASE / MEUBLE CAISSE			
	VEU 9 SUCB	VEU 12 SUCB	VEU 15 SUCB	VEU 18 SUCB	VEU 25 SUCB				
Precio Price Prix	SUCB		SIUCB						
Medidas Measures Mesures	[mm]	938 x 1285 x 905 mm.	1250 x 1285 x 905 mm.	1562 x 1285 x 905 mm.	1875 x 1285 x 905 mm.	2500 x 1285 x 905 mm.	938 x 1285 x 905 mm.	1250 x 1285 x 905 mm.	1562 x 1285 x 906 mm.
Temperatura Temperature Température	[°C]	0°C/+6°C					-		
Clase Climática Climatic class Classe climatique	[°C]	3 / 25°C					-		
Tensión/Frecuencia Electrical data Tension électrique		230V/1ph/50Hz					-		
Controlador Controller Régulateur		Digital					-		
Material Matériel	[EXT/INT]	Ext: acero plastificado / Plastified stainless steel / Acier plastifié Encimera / Worktop / Dessous: Inox Aisi 304 Plano exposición / Exhibition plan / Plan d'exposition: Acero plastif./ Plastif. Stainless steel/ Acier plastifié [Mod SU/SUCP] - Inox Aisi 304 [Mod. I]							
Aislamiento Isolation Isolation	[mm]	40kg/m ³ / Free CFC's / Zero ODP-GWP					-		
Capacidad Capacity Capacité	[L]	172	229	286	343	457	-		
Superficie exposición Surface exhibition Surface d'exposition	[m ²]	0,86	1,14	1,43	1,72	2,29	0,71	0,95	1,19
Compresor Compressor Compresseur	[HP]	3/4	5/8	3/4	1	1+1/4	-		
Estantes Shelving Étagères		-					-		
Costados (2) Sides (2) Joues (2)	[mm]	40+40							
Sistema de frío Cooling System Système de froid		Ventilado / Ventilated / Ventilé					-		
Desescarche Defrost Dégivrage		Automático / Automatic / Automatique					-		
Evaporación Evaporation Évaporation		Forzada / Forced / Ventilé					-		
Potencia Power Puissance	[W]	553	706	821	828	1212	20	20	20
Potencia frig. Cooling capacity Puissance Frig.	[W A -10°C]	-	-	-	-	-	-		
Consumo Consumption Consommation	[kWh/ 24h]	7,30	9,30	10,8	11,9	17,5	-		
Refrigerante Refrigerant Gaz		R-290					-		
Opcional Optional Options	Doble plano (sin reserva) / Double surface (without storage) / Double plan (sans réserve)								
		[DPEXVEU9S]	[DPEXVEU12S]	[DPEXVEU15S]	[DPEXVEU18S]	[DPEXVEU25S]			
	Doble plano INOX (sin reserva) / INOX double surface (without storage) / Double plan INOX (sans réserve)								
		[DPEXVEU9SI]	[DPEXVEU12SI]	[DPEXVEU15SI]	[DPEXVEU18SI]	[DPEXVEU25SI]			

Laterales no incluidos en el precio
Side panels not included in price
Joues non incluses dans le prix

Serie / Series / Série **EUROPA**

+Info: www.infrico.com

VEU 15 SUCB



Laterales / Sides / Joues

VEU C / M	
Incluidos / Includes / Inclus	

Laterales / Sides / Joues

NO	
Izquierdo Left Gauche	Derecho Right Droite
CP:	CP:



VEU 15 M

Ext. Estándar / Standar / Standard

Blanco/White/ Blanc	Ral 1001	Ral 1018
Ral 2003	Ral 3003	Ral 3020
Design 2108025	Ral 5015	Ral 4007
Ral 6002	Design 1107060	Design 3504035
Ral 9006	Ral 7016	Ral 8017

Colores fuera de carta /
Colors outside of letter /
Couleurs spéciales, hors palette

RAL		NO RAL	
Epoxi	Líquida/ Liquid/ Liquide	Epoxi	Líquida/ Liquid/ Liquide
[x unidad/x unit/x unité]		Consultar / Consultar / Consultar	
+10 días laborables / +10 work days / +10 jours ouvrés		Consultar / Consultar / Consultar	

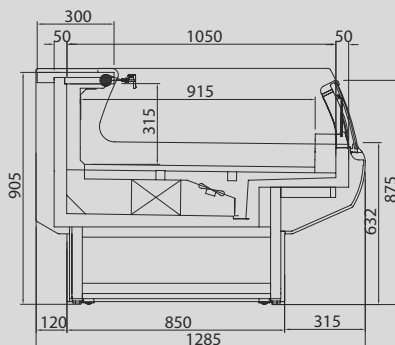



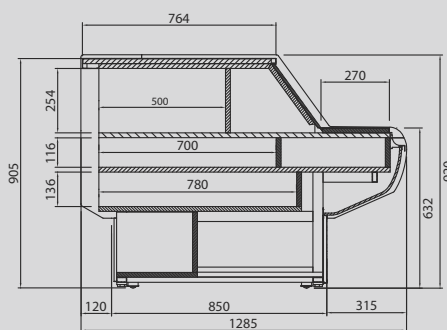





VEU 15 SUCB



VEU 15 M

Vitrina expositora modular frío ventilado autoservicio grupo remoto /
Refrigerated self service modular display remote case /
Vitrine présentation froid ventilé libre service canalisable groupe à distance

Mueble caja /
Counter case /
Meuble caisse

MODELO MODELE MODÈLE						MUEBLE CAJA / COUNTER CASE / MEUBLE CAISSE			
	VEU 9 SCB VEU 9 SICB	VEU 12 SCB VEU 12 SICB	VEU 15 SCB VEU 15 SICB	VEU 18 SCB VEU 18 SICB	VEU 25 SCB VEU 25 SICB				
Precio Price Prix	SCB SICB								
Medidas Measures Mesures	[mm] 938 x 1285 x 905 mm.	1250 x 1285 x 905 mm.	1562 x 1285 x 905 mm.	1875 x 1285 x 905 mm.	2500 x 1285 x 905 mm.	938 x 1285 x 905 mm.	1250 x 1285 x 905 mm.	1562 x 1285 x 906 mm.	
Temperatura Temperature Température	0°C/+6°C								
Clase Climática Climatic class Classe climatique	3 / 25°C								
Tensión/Frecuencia Electrical data Tension électrique	230V/1ph/50Hz								
Controlador Controller Régulateur	Digital								
Material Material Matériel	[EXT/INT] Ext: acero plastificado / Plastified stainless steel / Acier plastifié Encimera / Worktop / Dessous: Inox Aisi 304 Plano exposición / Exhibition plan / Plan d'exposition: Acero plastif./ Plastif. Stainless steel/ Acier plastifié [Mod RU/RUCP] - Inox Aisi 304 [Mod. I]								
Aislamiento Isolation Isolation	[mm] 40kg/m ³ / Free CFC's / Zero ODP-GWP								
Capacidad Capacity Capacité	[L] 172	229	286	343	457	-			
Superficie exposición Surface exhibition Surface d'exposition	[m ²] 0,86	1,14	1,43	1,72	2,29	0,71	0,95	1,19	
Compresor Compressor Compresseur	[HP] -	-	-	-	-	-			
Estantes Shelving Étagères	-								
Costados [2] Sides [2] Joues [2]	[mm] 40+40								
Sistema de frío Cooling System Système de froid	Ventilado / Ventilated / Ventilé								
Desescarche Defrost Dégivrage	Automático / Automatic / Automatique								
Evaporación Evaporation Évaporation	Forzada / Forced / Ventilé								
Potencia Power Puissance	[W] -	-	-	-	-	20	20	20	
Potencia frig. Cooling capacity Puissance Frig.	[W A -10°C] 676	1096	1315	1506	2009	-			
Consumo Consumption Consommation	[kWh/ 24h] -	-	-	-	-	-			
Refrigerante Refrigerant Gaz	R-290								
Opcional Optional Options	Doble plano [sin reserva] / Double surface [without storage] / Double plan [sans réserve]								
	[DPEXVEU9S]	[DPEXVEU12S]	[DPEXVEU15S]	[DPEXVEU18S]	[DPEXVEU25S]	-			
	Doble plano INOX [sin reserva] / INOX double surface [without storage] / Double plan INOX [sans réserve]								
	[DPEXVEU9SI]	[DPEXVEU12SI]	[DPEXVEU15SI]	[DPEXVEU18SI]	[DPEXVEU25SI]	-			

Laterales no incluidos en el precio
Side panels not included in price
Joues non incluses dans le prix

Serie / Series / Série **EUROPA**

+Info: www.infrico.com

VEU 15 M



VEU 15 SCB



Laterales / Sides / Joues

VEU C/M: SÍ

Laterales / Sides / Joues

VEU SCB: NO

Izquierdo Left Gauche	Derecho Right Droite
-----------------------------	----------------------------

Ext. Estándar / Standar / Standard

Blanco/White/ Blanc	Ral 1001	Ral 1018
Ral 2003	Ral 3003	Ral 3020
Design 2108025	Ral 5015	Ral 4007
Ral 6002	Design 1107060	Design 3504035
Ral 9006	Ral 7016	Ral 8017

VEU 9 C



**Colores fuera de carta /
Colors outside of letter /
Couleurs spéciales, hors palette**

RAL		NO RAL	
Epoxi	Líquida/ Liquid/ Liquide	Epoxi	Líquida/ Liquid/ Liquide
[x unidad/x unit/x unité]		Consultar / Consulter / Consulter	
+10 días laborables / +10 work days / +10 jours ouvrés		Consultar / Consulter / Consulter	

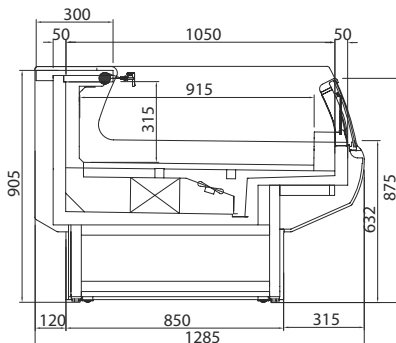



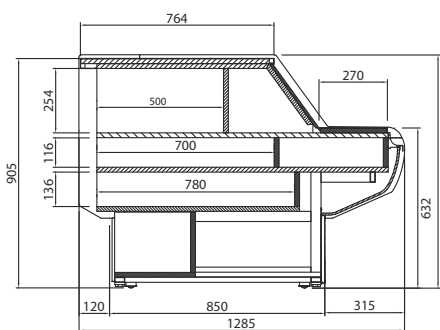











VEU 15 SCB



VEU 15 M

Vitrina Experience grupo incorporado / Plug in refrigerated display case Experience / Vitrine Experience groupe incorporé

		CRISTAL RECTO / FLAT GLASS / VITRE DROITE							
MODELO MODELE MODÈLE									
Precio Price Prix						NEW	NEW		
MOD.	VEX09 IU CP	VEX12 IU CP	VEX15 IU CP	VEX18 IU CP	VEX25 IU CP	VEX31 IU CP	VEX37 IU CP		
Precio PLANO INOX Price STAINL. STEEL SURF. Prix PLAN INOX						NEW	NEW		
		CRISTAL CURVO / CURVED GLASS / VITRE BOMBÉE							
MODELO MODELE MODÈLE									
Precio Price Prix						NEW	NEW		
MOD.	VEX09 IU	VEX12 IU	VEX15 IU	VEX18 IU	VEX25 IU	VEX31 IU	VEX37 IU		
Precio PLANO INOX Price STAINL. STEEL SURF. Prix PLAN INOX						NEW	NEW		
Medidas Mesures [mm]	938 x 1295 x 1220 mm.	1250 x 1295 x 1220 mm.	1562 x 1295 x 1220 mm.	1875 x 1295 x 1220 mm.	2500 x 1295 x 1220 mm.	3125 x 1295 x 1220 mm.	3750 x 1295 x 1220 mm.		
Temperatura Temperature Température [°C]	-1°C/+5°C								
Clase Climática Climatic class Classe climatique [°C]	3 / 25°C								
Tensión/Frecuencia Electrical data Tension électrique	230V/1ph/50Hz								
Controlador Controller Régulateur	Digital								
Material Matériel [EXT/INT]	Ext: acero plastificado / Plastified stainless steel / Acier plastifié Encimera / Worktop / Dessous: Inox Aisi 304 Plano exposición / Exhibition plan / Plan d'exposition: Acero plastif./ Plastif. Stainless steel/ Acier plastifié [Mod U/UCP] - Inox Aisi 304 [Mod. I]								
Aislamiento Isolation Isolation [mm]	40kg/m³ / Free CFC's / Zero ODP-GWP								
Capacidad Capacity Capacité [L]	169	225	281	338	450	563	675		
Superficie exposición Surface exhibition Surface d'exposition [m²]	0,84	1,13	1,41	1,69	2,25	2,81	3,40		
Compresor Compressor Compresseur [HP]	1/3	1/2	3/4	3/4	1 1/4	1 1/4	1 1/4		
Costados (2) Sides (2) Joues (2) [mm]	30 + 30								
Sistema de frío Cooling System Système de froid	Ventilado / Ventilated / Ventilé								
Desescarche Defrost Dégivrage	Automático / Automatic / Automatique								
Evaporación Evaporation Evaporation	Forzada / Forced / Ventilé								
Potencia Power Puissance [W]	484	650	714	810	1264	2461	2493		
Potencia frig. Cooling capacity Puissance Frig. [W A -10°C]	-								
Consumo Consumption Consommation [kWh/ 24h]	6,9	9,4	10,3	11,7	18,2	35,4	35,9		
Refrigerante Refrigerant Gaz	R-290								
Opcional Optional Options	Puertas correderas traseras / Rear sliding doors / Portes coulissantes arrière								
	R	P	R	P	R	P	R	P	
	Doble Plano / Double surface / Double plan								
	Doble plano Inox / Stainless steel double surface / Double plan Inox								
	Control de Condensación SSC / SCC Condensing Control / Contrôle de la Condensation SCC								

R: CRISTAL CURVO / CURVED GLASS / VITRE BOMBÉE
P: CRISTAL RECTO / FLAT GLASS / VITRE DROITE

Laterales no incluidos en el precio
Side panels not included in price
Joues non incluses dans le prix

Serie / Series / Série **VEX - EXPERIENCE**

+Info: www.infrico.com

VEX37UCP



Laterales / Sides / Joues

NO	
Izquierdo Left Gauche	Derecho Right Droite
CP:	CP:

VEX37U

Ext. Estándar / Standar / Standard

Blanco/White/ Blanc	Ral 1015	Ral 1018
Ral 2003	Ral 3003	Ral 3020
Ral 5015	Ral 5017	Ral 5011
Ral 6002	Ral 6018	Ral 6019
Ral 7035	Ral 7037	Ral 7042
Ral 7016	Negro/Black/ Noir	

**Colores fuera de carta /
Colors outside of letter /
Couleurs spéciales, hors palette**

RAL		NO RAL	
Epoxi	Líquida/ Liquid/ Liquide	Epoxi	Líquida/ Liquid/ Liquide
[x unidad/x unit/x unité]		Consultar / Consulter / Consulter	
+10 días laborables / +10 work days / +10 jours ouvrés		Consultar / Consulter / Consulter	

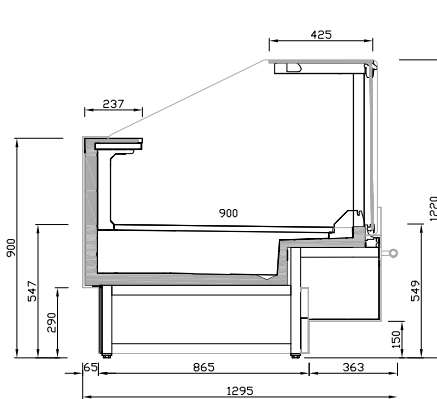



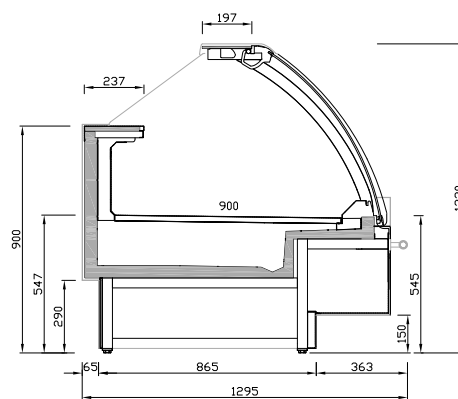

VEX UCP



VEX U

Vitrina Experience grupo incorporado / Plug in refrigerated display case Experience / Vitrine Experience groupe incorporé

MODELO MODELE MODÈLE					
	VEX09 U CB	VEX12 U CB	VEX15 U CB	VEX18 U CB	VEX25 U CB
Precio Price Prix					
MOD.	VEX09 IU CB	VEX12 IU CB	VEX15 IU CB	VEX18 IU CB	VEX25 IU CB
Precio PLANO INOX Price STAINL.STEEL SURF. Prix PLAN INOX					
Medidas Measures (mm) Mesures	938 x 1225 x 875 mm.	1250 x 1225 x 875 mm.	1562 x 1225 x 875 mm.	1875 x 1225 x 875 mm.	2500 x 1225 x 875 mm.
Temperatura Temperature (°C) Température	-1°C/+7°C				
Clase Climática Climatic class (°C) Classe climatique	3 / 25°C				
Tensión/Frecuencia Electrical data Tension électrique	230V/1ph/50Hz				
Controlador Controller Régulateur	Digital				
Material Matériel (EXT/INT)	Ext: acero plastificado / Plastified stainless steel / Acier plastifié Encimera / Worktop / Dessous: Inox Aisi 304 Plano exposición / Exhibition plan / Plan d'exposition: Acero plastif./ Plastif. Stainless steel/ Acier plastifié (Mod U CB) - Inox Aisi 304 (Mod. I)				
Aislamiento Isolation (mm) Isolation	40kg/m ³ / Free CFC's / Zero ODP-GWP				
Capacidad Capacity (L) Capacité	169	225	281	338	450
Superficie exposición Surface exhibition (m ²) Surface d'exposition	0,84	1,13	1,41	1,69	2,25
Compresor Compressor (HP) Compresseur	3/4	3/4	1	1	1 1/4
Costados [2] Sides [2] (mm) Joues [2]	30 + 30				
Sistema de frío Cooling System Système de froid	Ventilado / Ventilated / Ventilé				
Desescarche Defrost Dégivrage	Automático / Automatic / Automatique				
Evaporación Evaporation Évaporation	Forzada / Forced / Ventilé				
Potencia Power (W) Puissance	503	590	682	780	1005
Potencia frig. Cooling capacity (W A -10°C) Puissance Frig.	-				
Consumo Consumption (kWh/24h) Consommation	6,64	7,80	9,10	9,80	13,3
Refrigerante Refrigerant Gaz	R-290				
Opcional Optional Options	Doble Plano / Double surface / Double plan	Doble Plano / Double surface / Double plan	Doble Plano / Double surface / Double plan	Doble Plano / Double surface / Double plan	Doble Plano / Double surface / Double plan
	Doble plano Inox / Stainl. steel double surface / Double plan Inox	Doble plano Inox / Stainl. steel double surface / Double plan Inox	Doble plano Inox / Stainl. steel double surface / Double plan Inox	Doble plano Inox / Stainl. steel double surface / Double plan Inox	Doble plano Inox / Stainl. steel double surface / Double plan Inox
	Control de Condensación SSC / SCC Condensing Control / Contrôle de la Condensation SCC				

Laterales no incluidos en el precio
Side panels not included in price
Joues non incluses dans le prix

Serie / Series / Série **VEX - EXPERIENCE**

+Info: www.infrico.com

VEX25UCB



Laterales / Sides / Joues

NO	
Izquierdo Left Gauche	Derecho Right Droite
CB:	CB:

Ext. Estándar / Standar / Standard

Blanco/White/ Blanc	Ral 1015	Ral 1018
Ral 2003	Ral 3003	Ral 3020
Ral 5015	Ral 5017	Ral 5011
Ral 6002	Ral 6018	Ral 6019
Ral 7035	Ral 7037	Ral 7042
Ral 7016	Negro/Black/ Noir	

Colores fuera de carta /
Colors outside of letter /
Couleurs spéciales, hors palette





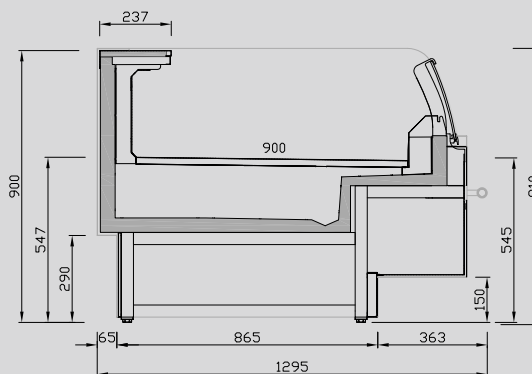

RAL		NO RAL	
Epoxi	Líquida/ Liquid/ Liquide	Epoxi	Líquida/ Liquid/ Liquide
		Consultar / Consultar / Consulter	
[x unidad/x unit/x unité]			
+10 días laborables / +10 work days / +10 jours ouvrés		Consultar / Consultar / Consulter	

VEX25UCB



VEX UCB

Vitrina Experience grupo incorporado / Plug in refrigerated display case Experience / Vitrine Experience groupe incorporé

MODELO MODELE MODÈLE						
	ÁNGULOS / ANGLES / ANGLES					
	VEX 90 AC U	VEX 90 AA U	VEX 45 AC U	VEX 45 AA	VEX 90 AC UCP	VEX 90 AA UCP
Precio Price Prix				NEUTRO/NEUTRAL/NEUTRE		
MOD.	VEX 90 AC IU	VEX 90 AA IU	VEX 45 AC IU	VEX 45 AA I	VEX 90 AC IUCP	VEX 90 AA IUCP
Precio PLANO INOX Price STAINL.STEEL SURF. Prix PLAN INOX				NEUTRO/NEUTRAL/NEUTRE		
Medidas Measures Mesures (mm)	2769 x 1225 x 1220 mm.	1882 x 1225 x 1220 mm.	1531 x 1225 x 1220 mm.	1050 x 1225 x 1220 mm.	2769 x 1225 x 1220 mm.	1882 x 1225 x 1220 mm.
Temperatura Temperature Température (°C)	-1°C/+5°C					
Clase Climática Climatic class Classe climatique (°C)	3 / 25°C					
Tensión/Frecuencia Electrical data Tension électrique	230V/1ph/50Hz					
Controlador Controller Régulateur	Digital					
Material Matériel (EXT/INT)	Ext: acero plastificado / Plastified stainless steel / Acier plastifié Encimera / Worktop / Dessous: Inox Aisi 304 Plano exposición / Exhibition plan / Plan d'exposition: Acero plastif./ Plastif. Stainless steel/ Acier plastifié [Mod AA/AC] - Inox Aisi 304 [Mod. I]					
Aislamiento Isolation Isolation (mm)	40kg/m ³ / Free CFC's / Zero ODP-GWP					
Capacidad Capacity Capacité (L)	456	205	-	-	456	205
Superficie exposición Surface exhibition Surface d'exposition (m ²)	1,85	1,10	0,92	0,60	1,85	1,10
Compresor Compressor Compresseur (HP)	1/2	1/2	-	Sin unidad Without unity Sans unité	1/2	1/2
Estantes Shelving Étagères	-					
Costados [2] Sides [2] Joues [2] (mm)	30+30					
Sistema de frío Cooling System Système de froid	Ventilado / Ventilated / Ventilé					
Desescarche Defrost Dégivrage	Automático / Automatic / Automatique					
Evaporación Evaporation Évaporation	Forzada / Forced / Ventilé					
Potencia Power Puissance (W)	830	768	663	35	830	768
Potencia frig. Cooling capacity Puissance Frig. (W A -10°C)	-	-	-	Sin unidad Without unity Sans unité	-	-
Consumo Consumption Consommation (kWh/ 24h)	1,1	1,3	0,5	0,5	1,1	1,3
Refrigerante Refrigerant Gaz	R-290					
Opcional Optional Options	Doble plano [sin reserva] / Double surface [without storage] / Double plan [sans réserve] - Modelo/Model/Modèle I: Inox					
	I:	I:	I:	I:	I:	I:
	Puertas correderas traseras / Rear sliding doors / Portes coulissantes arrière					
	Control de Condensación SSC / SCC Condensing Control / Contrôle de la Condensation SCC					

Laterales no incluidos en el precio
Side panels not included in price
Joues non incluses dans le prix

Serie / Series / Série **VEX - EXPERIENCE**

+Info: www.infrico.com

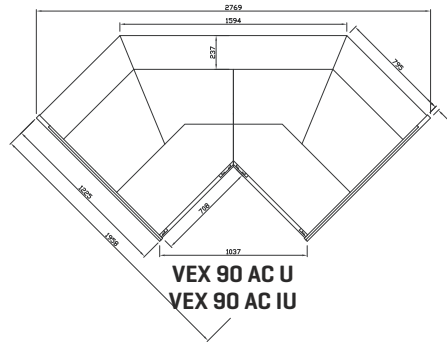

VEX 90 AC U
VEX 90 AC IU

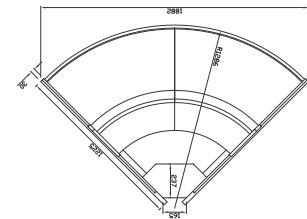

VEX 90 AA U
VEX 90 AA IU

Laterales / Sides / Joues

NO	
Izquierdo Left Gauche	Derecho Right Droite
AA/AC:	AA/AC:
CP:	CP:

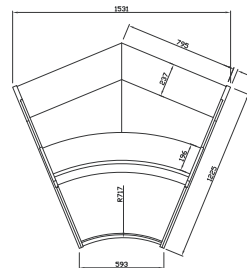

VEX 45 AC U
VEX 45 AC IU

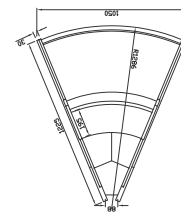

VEX 45 AA U
VEX 45 AA IU

Ext. Estándar / Standar / Standard

Blanco/White/ Blanc	Ral 1015	Ral 1018
Ral 2003	Ral 3003	Ral 3020
Ral 5015	Ral 5017	Ral 5011
Ral 6002	Ral 6018	Ral 6019
Ral 7035	Ral 7037	Ral 7042
Ral 7016	Negro/Black/ Noir	

Colores fuera de carta /
Colors outside of letter /
Couleurs spéciales, hors palette

RAL		NO RAL	
Epoxi	Líquida/ Liquid/ Liquide	Epoxi	Líquida/ Liquid/ Liquide
[x unidad/x unit/x unité]		Consultar / Consultar / Consulter	
+10 días laborables / +10 work days / +10 jours ouvrés		Consultar / Consultar / Consulter	

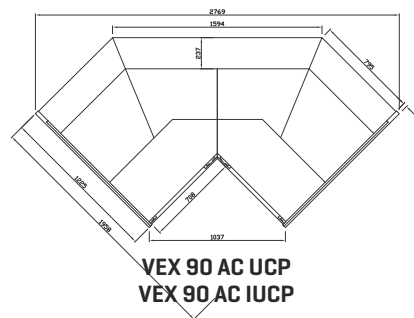



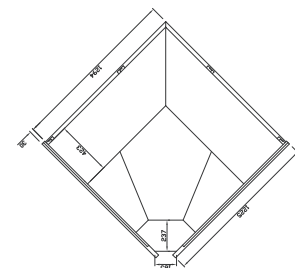



VEX 90 AC UCP
VEX 90 AC IUCP



VEX 90 AA UCP
VEX 90 AA IUCP

Vitr. Experience torre de carne /
Meat tower Experience display counter /
Vitrine Experience tour de viande

Vitrina Experience caliente /
Experience hot display counter /
Vitrine Experience chaude

MODELO MODELE MODÈLE	REMOTA / REMOTE / GROUPE À DIST.		GRUPO INCORP. / PLUG IN / GR. INCORPORÉ		CALIENTE / HOT / CHAUDE	
	 VEX09 CA	 VEX12 CA	 VEX09 U CA	 VEX12 U CA	 VEX12 CP HT	 VEX25 CP HT
Precio Price Prix						
Medidas Measures Mesures [mm]	Sin costados Without sides Sans joues 938 x 930 x 1500 mm.	Sin costados Without sides Sans joues 1250 x 930 x 1500 mm.	938 x 930 x 1500 mm.	1250 x 930 x 1500 mm.	1250 x 1225 x 1220 mm.	2500 x 1225 x 1220 mm.
Temperatura Temperature Température [°C]	-1°C/+5°C				+65°C	
Clase Climática Climatic class Classe climatique [°C]	3 / 25°C					
Tensión/Frecuencia Electrical data Tension électrique	230V/1ph/50Hz				380V/3ph/50Hz	
Controlador Controller Régulateur	Digital					
Material Matériel [EXT/INT]	Ext: acero plastificado / Plastified stainless steel / Acier plastifié Encimera / Worktop / Dessous: Inox Aisi 304 Plano exposición / Exhibition plan / Plan d'exposition: Inox Aisi 304					
Aislamiento Isolation Isolation [mm]	40kg/m ³ / Free CFC's / Zero ODP-GWP					
Capacidad Capacity Capacité [L]	190	253	190	253	225	450
Superficie exposición Surface exhibition Surface d'exposition [m ²]	1,08	1,44	1,08	1,44	1,13	2,25
Compresor Compressor Compresseur [HP]	-		3 1/4	1 1/4	-	
Estantes Shelving Étagères	2				-	
Costados [2] Sides [2] Joues [2] [mm]	30+30		Laterales incluidos / Side panels included / Joues inclus			
Sistema de frío Cooling System Système de froid	Ventilado / Ventilated / Ventilé				-	
Desescarche Defrost Dégivrage	Automático / Automatic / Automatique				-	
Evaporación Evaporation Évaporation	Forzada / Forced / Ventilé				-	
Potencia Power Puissance [W]	-		784	893	2153	4305
Potencia frig. Cooling capacity Puissance Frig. [W A -10°C]	1500	2200	-			
Consumo Consumption Consommation [kWh/ 24h]	-		12,1	14,3	12,9	25,8
Refrigerante Refrigerant Gaz	FREON		R-290		-	
Opcional Optional Options	Separador panorámico / Panoramic divider / Séparateur panoramique				-	

Laterales no incluidos en el precio
Side panels not included in price
Joues non inclus dans le prix

NEW

Series / Série **VEX - EXPERIENCE**

+Info: www.infrico.com

VEX25 CP HT



Laterales / Sides / Jous

VEX UCA / CP HT
Incluidos / Includes / Inclus

Laterales / Sides / Jous

NO	
Izquierdo Left Gauche	Derecho Right Droite
VEX CA:	VEX CA:



VEX12 CA

Ext. Estándar / Standar / Standard

Blanco/White/ Blanc	Ral 1015	Ral 1018
Ral 2003	Ral 3003	Ral 3020
Ral 5015	Ral 5017	Ral 5011
Ral 6002	Ral 6018	Ral 6019
Ral 7035	Ral 7037	Ral 7042
Ral 7016	Negro/Black/ Noir	

**Colores fuera de carta /
Colors outside of letter /
Couleurs spéciales, hors palette**

RAL		NO RAL	
Epoxi	Líquida/ Liquid/ Liquide	Epoxi	Líquida/ Liquid/ Liquide
[x unidad/x unit/x unité]		Consultar / Consulter / Consulter	
+10 días laborables / +10 work days / +10 jours ouvrés		Consultar / Consulter / Consulter	

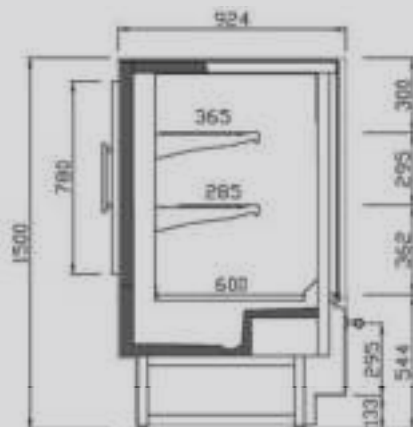



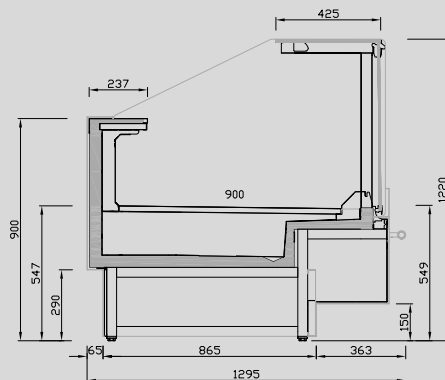











VEX CA



VEX CP HT

Vitrina Experience remota / Experience refrigerated self service remote case / Vitrine Experience groupe à distance

		CRISTAL RECTO / FLAT GLASS / VITRE DROITE						
MODELO MODELE MODÈLE								
Precio Price Prix								
MOD.	VEX09 I CP	VEX12 I CP	VEX15 I CP	VEX18 I CP	VEX25 I CP	VEX31 I CP	VEX37 I CP	
Precio PLANO INOX Price STAINL. STEEL SURF. Prix PLAN INOX								
		CRISTAL CURVO / CURVED GLASS / VITRE BOMBÉE						
MODELO MODELE MODÈLE								
Precio Price Prix								
MOD.	VEX09 I	VEX12 I	VEX15 I	VEX18 I	VEX25 I	VEX31 I	VEX37 I	
Precio PLANO INOX Price STAINL. STEEL SURF. Prix PLAN INOX								
Medidas / Measures / Mesures / (mm) Sin costados / Without sides / Sans joues	938 x 1295 x 1220 mm.	1250 x 1295 x 1220 mm.	1562 x 1295 x 1220 mm.	1875 x 1295 x 1220 mm.	2500 x 1295 x 1220 mm.	3125 x 1295 x 1220 mm.	3750 x 1295 x 1220 mm.	
Temperatura Temperature Température (°C)	-1°C/+5°C							
Clase Climática Climatic class Classe climatique (°C)	3 / 25°C							
Tensión/Frecuencia Electrical data Tension électrique	230V/1ph/50Hz							
Controlador Controller Régulateur	Digital							
Material Matériel (EXT/INT)	Ext: acero plastificado / Plastified stainless steel / Acier plastifié Encimera / Worktop / Dessous: Inox Aisi 304 Plano exposición / Exhibition plan / Plan d'exposition: Acero plastif. / Plastif. Stainless steel / Acier plastifié (Mod VEX/VEXCP) - Inox Aisi 304 (Mod. I)							
Aislamiento Isolation Isolation (mm)	40kg/m³ / Free CFC's / Zero ODP-GWP							
Capacidad Capacity Capacité (L)	169	225	281	338	450	563	675	
Superficie exposición Surface exhibition Surface d'exposition (m²)	0,84	1,13	1,41	1,69	2,25	2,81	3,40	
Compresor Compressor Compresseur (HP)	-							
Costados (2) Sides (2) Joues (2) (mm)	30 + 30							
Sistema de frío Cooling System Système de froid	Ventilado / Ventilated / Ventilé							
Desescarche Defrost Dégivrage	Automático / Automatic / Automatique							
Evaporación Evaporation Évaporation	Forzada / Forced / Ventilé							
Potencia frig. Cooling capacity Puissance Frig. (W A -10°C)	610	813	1015	1219	1626	2031	2438	
Refrigerante Refrigerant Gaz	FREON							
Opcional Optional Options	Puertas correderas traseras / Rear sliding doors / Portes coulissantes arrière							
	R	R	R	R	R	R	R	
	P	P	P	P	P	P	P	
	Doble Plano / Double surface / Double plan							
	Doble plano Inox / Stainless steel double surface / Double plan Inox							
	Control de Condensación SSC / SCC Condensing Control / Contrôle de la Condensation SCC							

R: CRISTAL CURVO / CURVED GLASS / VITRE BOMBÉE
P: CRISTAL RECTO / FLAT GLASS / VITRE DROITE

Laterales no incluidos en el precio
Side panels not included in price
Joues non incluses dans le prix

Serie / Series / Série **VEX - EXPERIENCE**

+Info: www.infrico.com

VEX25CP



Laterales / Sides / Joues

NO	
Izquierdo Left Gauche	Derecho Right Droite
CP:	CP:

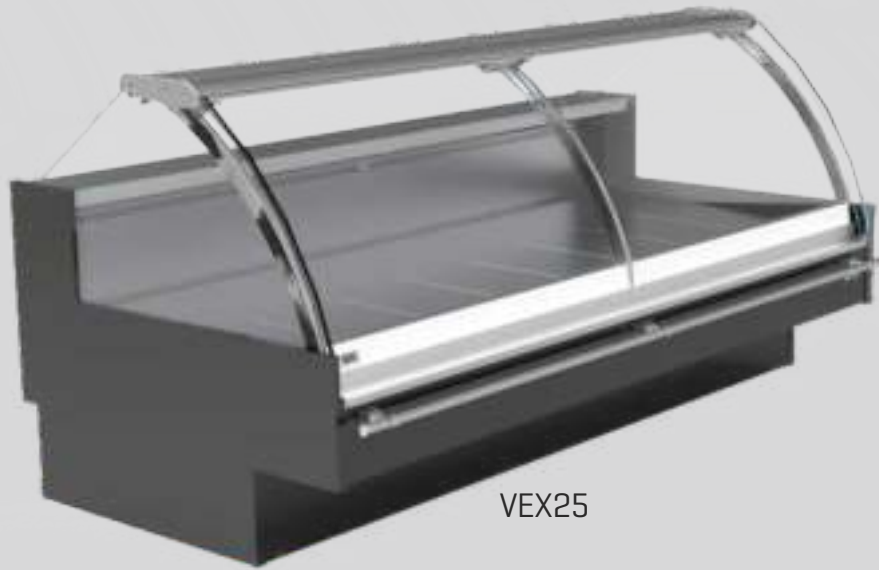

VEX25

Ext. Estándar / Standar / Standard

Blanco/White/ Blanc	Ral 1015	Ral 1018
Ral 2003	Ral 3003	Ral 3020
Ral 5015	Ral 5017	Ral 5011
Ral 6002	Ral 6018	Ral 6019
Ral 7035	Ral 7037	Ral 7042
Ral 7016	Negro/Black/ Noir	

**Colores fuera de carta /
Colors outside of letter /
Couleurs spéciales, hors palette**

RAL		NO RAL	
Epoxi	Líquida/ Liquid/ Liquide	Epoxi	Líquida/ Liquid/ Liquide
[x unidad/x unit/x unité]		Consultar / Consulter / Consulter	
+10 días laborables / +10 work days / +10 jours ouvrés		Consultar / Consulter / Consulter	

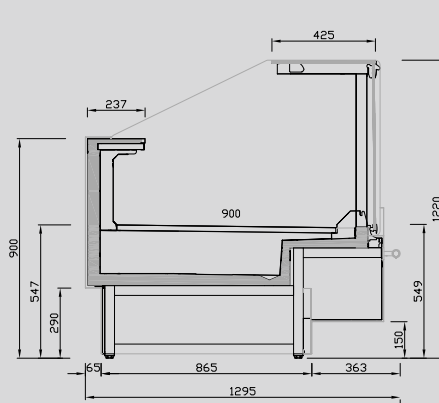



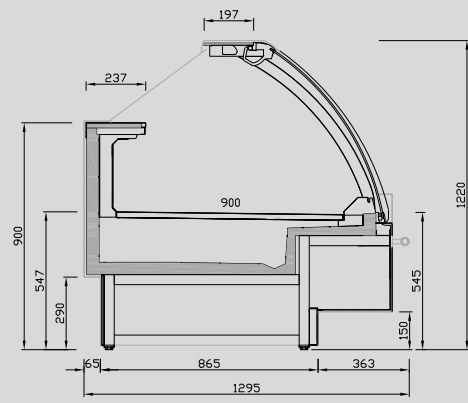

VEX CP



VEX

Vitrina Experience remota / Experience refrigerated self service remote case / Vitrine Experience groupe à distance

CRISTAL BAJO / LOW GLASS / VITRE BASS

MODELO MODELE MODÈLE	 VEX09 CB	 VEX12 CB	 VEX15 CB	 VEX18 CB	 VEX25 CB
Precio Price Prix					
MOD.	VEX09 I CB	VEX12 I CB	VEX15 I CB	VEX18 I CB	VEX25 I CB
Precio PLANO INOX Price STAINL. STEEL SURF. Prix PLAN INOX					
Medidas / Measures / Mesures / [mm] Sin costados / Without sides / Sans joues	938 x 1225 x 875 mm.	1250 x 1225 x 875 mm.	1562 x 1225 x 875 mm.	1875 x 1225 x 875 mm.	2500 x 1225 x 875 mm.
Temperatura Temperature [°C] Température	-1°C/+7°C				
Clase Climática Climatic class [°C] Classe climatique	3 / 25°C				
Tensión/Frecuencia Electrical data Tension électrique	230V/1ph/50Hz				
Controlador Controller Régulateur	Digital				
Material Material [EXT/INT] Matériel	Ext: acero plastificado / Plastified stainless steel / Acier plastifié Encimera / Worktop / Dessous: Inox Aisi 304 Plano exposición / Exhibition plan / Plan d'exposition: Acero plastif. / Plastif. Stainless steel/ Acier plastifié [Mod CB] - Inox Aisi 304 [Mod. I]				
Aislamiento Isolation Isolation [mm]	40kg/m ³ / Free CFC's / Zero ODP-GWP				
Capacidad Capacity Capacité [L]	169	225	281	338	450
Superficie exposición Surface exhibition Surface d'exposition [m ²]	0,84	1,13	1,41	1,69	2,25
Compresor Compressor Compresseur [HP]	-				
Costados [2] Sides [2] Joues [2] [mm]	30 + 30				
Sistema de frío Cooling System Système de froid	Ventilado / Ventilated / Ventilé				
Desescarche Defrost Dégivrage	Automático / Automatic / Automatique				
Evaporación Evaporation Evaporation	Forzada / Forced / Ventilé				
Potencia Power Puissance [W]	-				
Potencia frig. Cooling capacity Puissance Frig. [W A -10°C]	750	1000	1250	1500	2000
Consumo Consumption Consommation [kWh/ 24h]	-				
Refrigerante Refrigerant Gaz	FREON				
Opcional Optional Options	Doble Plano / Double surface / Double plan	Doble Plano / Double surface / Double plan	Doble Plano / Double surface / Double plan	Doble Plano / Double surface / Double plan	Doble Plano / Double surface / Double plan
	Doble plano Inox / Stainl. steel double surface / Double plan Inox	Doble plano Inox / Stainl. steel double surface / Double plan Inox	Doble plano Inox / Stainl. steel double surface / Double plan Inox	Doble plano Inox / Stainl. steel double surface / Double plan Inox	Doble plano Inox / Stainl. steel double surface / Double plan Inox
	Control de Condensación SSC / SCC Condensing Control / Contrôle de la Condensation SCC				

Laterales no incluidos en el precio
Side panels not included in price
Joues non incluses dans le prix

Serie / Series / Série **VEX - EXPERIENCE**

+Info: www.infrico.com

VEX25CB



Laterales / Sides / Joues

NO	
Izquierdo Left Gauche	Derecho Right Droite
CB:	CB:

Ext. Estándar / Standar / Standard

Blanco/White/ Blanc	Ral 1015	Ral 1018
Ral 2003	Ral 3003	Ral 3020
Ral 5015	Ral 5017	Ral 5011
Ral 6002	Ral 6018	Ral 6019
Ral 7035	Ral 7037	Ral 7042
Ral 7016	Negro/Black/ Noir	

**Colores fuera de carta /
Colors outside of letter /
Couleurs spéciales, hors palette**





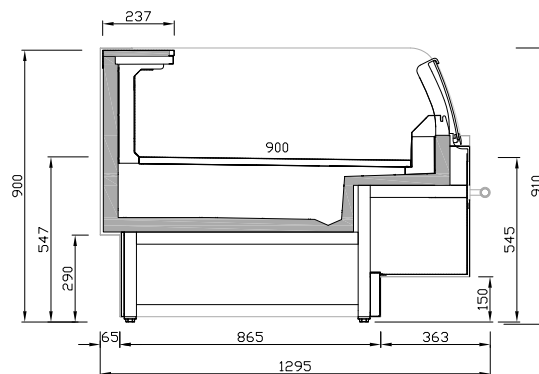

RAL		NO RAL	
Epoxi	Líquida/ Liquid/ Liquide	Epoxi	Líquida/ Liquid/ Liquide
[x unidad/x unit/x unité]		Consultar / Consultar / Consulter	
+10 días laborables / +10 work days / +10 jours ouvrés		Consultar / Consultar / Consulter	

VEX25CB



VEX CB

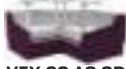





Vitrina Experience remota / Experience refrigerated self service remote case / Vitrine Experience groupe à distance

	ÁNGULOS / ANGLES / ANGLES					
MODELO MODELE MODÈLE						
Precio Price Prix						
MOD.	VEX 90 ACI	VEX 90 AAI	VEX 45 ACI	VEX 45 AAI	VEX 90 AC I CP	VEX 90 AA I CP
Precio PLANO INOX Price STAINL.STEEL SURF. Prix PLAN INOX						
Medidas / Measures / Mesures / [mm] Sin costados / Without sides / Sans joues	2769 x 1225 x 1220 mm.	1882 x 1225 x 1220 mm.	1531 x 1225 x 1220 mm.	1050 x 1225 x 1220 mm.	2769 x 1225 x 1220 mm.	1882 x 1225 x 1220 mm.
Temperatura Temperature [°C] Température	-1°C/+7°C					
Clase Climática Climatic class [°C] Classe climatique	3 / 25°C					
Tensión/Frecuencia Electrical data Tension électrique	230V/1ph/50Hz					
Controlador Controller Régulateur	Digital					
Material Material [EXT/INT]	Ext: acero plastificado / Plastified stainless steel / Acier plastifié Encimera / Worktop / Dessous: Inox Aisi 304 Plano exposición / Exhibition plan / Plan d'exposition: Acero plastif./ Plastif. Stainless steel/ Acier plastifié [Mod AC/AA] - Inox Aisi 304 [Mod. I]					
Aislamiento Isolation [mm]	40kg/m ³ / Free CFC's / Zero ODP-GWP					
Capacidad Capacity [L] Capacité	456	205	-	-	456	205
Superficie exposición Surface exhibition [m ²] Surface d'exposition	1,85	1,10	0,92	0,60	1,85	1,10
Compresor Compressor [HP] Compresseur	-					
Estantes Shelving Étagères	-					
Costados [2] Sides [2] [mm] Joues [2]	30+30					
Sistema de frío Cooling System Système de froid	Ventilado / Ventilated / Ventilé					
Desescarche Defrost Dégivrage	Automático / Automatic / Automatique					
Evaporación Evaporation Évaporation	Forzada / Forced / Ventilé					
Potencia Power [W] Puissance	-					
Potencia frig. Cooling capacity [W A -10°C] Puissance Frig.	1700	855	852	NEUTRO	1790	900
Consumo Consumption [kWh/ 24h] Consommation	-					
Refrigerante Refrigerant Gaz	FREON					
Opcional Optional Options	Doble plano [sin reserva] / Double surface [without storage] / Double plan [sans réserve] - Modelo/Model/Modèle I: Inox					
	I:	I:	I:	I:	I:	I:
	Puertas correderas traseras / Rear sliding doors / Portes coulissantes arrière					
	Control de Condensación SSC / SCC Condensing Control / Contrôle de la Condensation SCC					

Laterales no incluidos en el precio
Side panels not included in price
Joues non incluses dans le prix

Vitrina estrecha remota Take Away /
Narrow remote Take Away refrig. display counter /
Vitrine étroite Take Away groupe à distance

Vitr. Experience torre de carne /
Meat tower Experience display counter /
Vitrine Experience tour de viande

MODELO MODELE MODÈLE	 VEE 12	 VEE 18	 VEE 25	 VEE 09 CA	 VEE CA	 VEE 12 CA
Precio Price Prix						
Medidas / Measures / Mesures / (mm) Sin costados / Without sides / Sans joues	1250 x 930 x 1220 mm.	1875 x 930 x 1220 mm.	2500 x 930 x 1220 mm.	938 x 930 x 1500 mm.		1250 x 930 x 1500 mm.
Temperatura Temperature (°C) Température	-1°C/+5°C					
Clase Climática Climatic class Classe climatique	3 / 25°C					
Tensión/Frecuencia Electrical data Tension électrique	230V/1ph/50Hz					
Controlador Controller Régulateur	Digital					
Material Material (EXT/INT) Matériel	Ext: acero plastificado / Plastified stainless steel / Acier plastifié Encimera / Worktop / Dessous: Inox Aisi 304 Plano exposición / Exhibition plan / Plan d'exposition: Inox Aisi 304					
Aislamiento Isolation Isolation (mm)	40kg/m ³ / Free CFC's / Zero ODP-GWP					
Capacidad Capacity Capacité (L)	225	338	450	312		416
Superficie exposición Surface exhibition Surface d'exposition (m ²)	0,75	1,13	1,50	1,14		1,51
Compresor Compressor Compresseur (HP)	-					
Costados [2] Sides [2] Joues [2] (mm)	30 + 30					
Sistema de frío Cooling System Système de froid	Ventilado / Ventilated / Ventilé					
Desescarche Defrost Dégivrage	Automático / Automatic / Automatique			Gas caliente / hot gas / Gaz chaud		
Evaporación Evaporation Évaporation	Forzada / Forced / Ventilé					
Potencia Power Puissance (W)	-					
Potencia frig. Cooling capacity Puissance Frig. (W A -10°C)	723	1164	1598	1453		1598
Consumo Consumption Consommation (kWh/ 24h)	-					
Refrigerante Refrigerant Gaz	R-290					
Opcional Optional Options	Puertas correderas / Sliding doors / Portes coulissantes VEE 12 VEE 18 VEE 25			-		

Laterales no incluidos en el precio
Side panels not included in price
Joues non incluses dans le prix

NEW

Series / Série **VEE - EXPERIENCE FOR EAT**

+Info: www.infrico.com

VEE25



Laterales / Sides / Joues

NO	
Izquierdo Left Gauche	Derecho Right Droite
VEE:	VEE:
VEE CA:	VEE CA:

Ext. Estándar / Standar / Standard

Blanco/White/ Blanc	Ral 1015	Ral 1018
Ral 2003	Ral 3003	Ral 3020
Ral 5015	Ral 5017	Ral 5011
Ral 6002	Ral 6018	Ral 6019
Ral 7035	Ral 7037	Ral 7042
Ral 7016	Negro/Black/ Noir	

VEE12 CA

**Colores fuera de carta /
Colors outside of letter /
Couleurs spéciales, hors palette**

RAL		NO RAL	
Epoxi	Líquida/ Liquid/ Liquide	Epoxi	Líquida/ Liquid/ Liquide
[x unidad/x unit/x unité]		Consultar / Consulter / Consulter	
+10 días laborables / +10 work days / +10 jours ouvrés		Consultar / Consulter / Consulter	

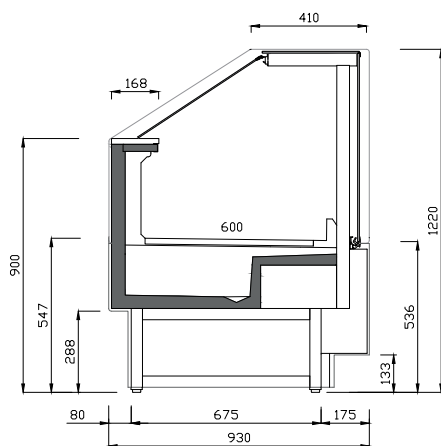



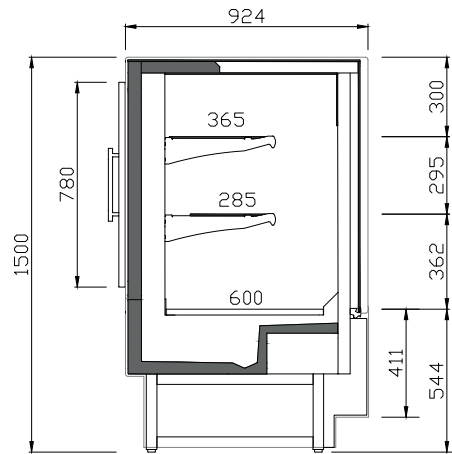

VEE



VEE CA

Vitrina Experience caliente / Experience hot display counter / Vitrine Experience chaude **(VEE HT)**
Vitr. Experience Gastronorm / Experience Gastronorm disp. count. / Vitr. Experience Gastronorme **(VEE GC)**
Vitrina Experience estrecha / Experience narrow display counter / Vitrine Experience étroite **(VEES)**
Vitrina Experience neutra / Experience neutral display counter / Vitrine Experience neutre **(VEEN)**

MODELO MODELE MODÈLE	 VEE 12 HT	 VEE 12 GC	 VEE 12 S	 VEE 90 AAM
Precio Price Prix				
Medidas / Measures / Mesures / (mm) Sin costados / Without sides / Sans joues	1330 x 930 x 1220 mm.	1330 x 930 x 1220 mm.	1250 x 930 x 1220 mm.	1330 x 930 x 1220 mm.
Temperatura Temperature (°C) Température	+65°C		-1°C/+5°C	
Clase Climática Climatic class Classe climatique (°C)	-		3 / 25°C	
Tensión/Frecuencia Electrical data Tension électrique	230V/1ph/50Hz			
Controlador Controller Régulateur	Digital			
Material Material (EXT/INT) Matériel	Ext: acero plastificado / Plastified stainless steel / Acier plastifié Encimera / Worktop / Dessous: Inox Aisi 304 Plano exposición / Exhibition plan / Plan d'exposition: Inox Aisi 304			
Aislamiento Isolation Isolation (mm)	40kg/m ³ / Free CFC's / Zero ODP-GWP			
Capacidad Capacity Capacité (L)	225	90	135	-
Superficie exposición Surface exhibition Surface d'exposition (m ²)	0,75	-	0,89	-
Compresor Compressor Compresseur (HP)	-			
Costados [2] Sides [2] Joues [2] (mm)	30 + 30			
Sistema de frío Cooling System Système de froid	Ventilado / Ventilated / Ventilé			
Desescarche Defrost Dégivrage	Automático / Automatic / Automatique			
Evaporación Evaporation Évaporation	Forzada / Forced / Ventilé			
Potencia Power Puissance (W)	2250	2600	-	-
Potencia frig. Cooling capacity Puissance Frig. (W A -10°C)	-	-	1522	-
Consumo Consumption Consommation (kWh/ 24h)	21,6	24,9	-	-
Refrigerante Refrigerant Gaz	R-290			
Opcional Optional Options	Puertas correderas / Sliding doors / Portes coulissantes VEE 12 S			-

Laterales no incluidos en el precio
Side panels not included in price
Joues non incluses dans le prix

NEW

Series / Série **VEE - EXPERIENCE FOR EAT**

+Info: www.infrico.com



VEE 12 HT



VEE 12 GC



VEE 12 S

Laterales / Sides / Jous

VEE HT / GC / AAM
Incluidos / Includes / Inclus

Laterales / Sides / Jous

NO	
Izquierdo Left Gauche	Derecho Right Droite
S:	S:

VEE 90 AAMS



Ext. Estándar / Standar / Standard

Blanco/White/ Blanc	Ral 1015	Ral 1018
Ral 2003	Ral 3003	Ral 3020
Ral 5015	Ral 5017	Ral 5011
Ral 6002	Ral 6018	Ral 6019
Ral 7035	Ral 7037	Ral 7042
Ral 7016	Negro/Black/ Noir	

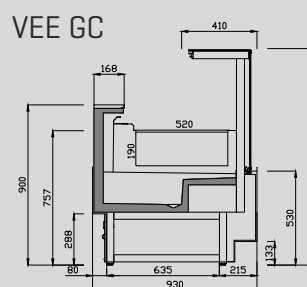
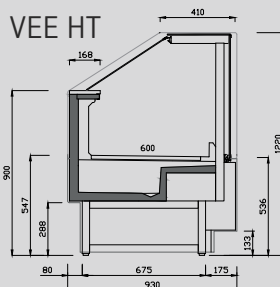

Colores fuera de carta /
Colors outside of letter /
Couleurs spéciales, hors palette



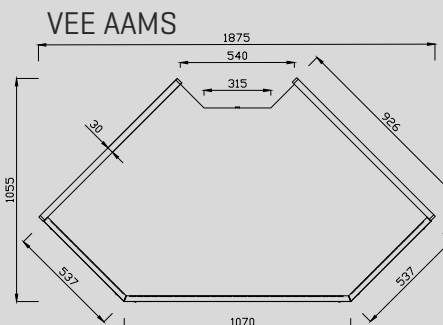
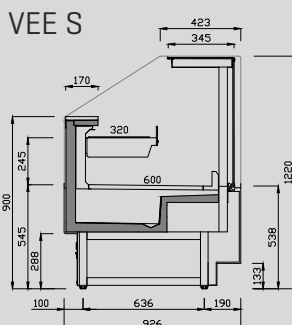



RAL		NO RAL	
Epoxi	Líquida/ Liquid/ Liquide	Epoxi	Líquida/ Liquid/ Liquide
		Consultar / Consultar / Consulter	
[x unidad/x unit/x unité]			
+10 días laborables / +10 work days / +10 jours ouvrés		Consultar / Consultar / Consulter	



Vitrina estrecha grupo incorporado / Narrow plug in refriger. display counter / Vitrine étroite groupe incorporé (VEE U)

Vitr. torre de carne grupo incorp. / Meat tower plug in display counter / Vitrine tour de viande groupe incorporé (VEE U CA)

Vitrina estrecha Take Away / Take Away narrow display counter / Vitrine étroite Take Away (VEE U S)

MODELO MODELE MODÈLE						
Precio Price Prix						
Medidas Measures [mm] Mesures	1250 x 930 x 1220 mm.	1875 x 930 x 1220 mm.	2500 x 930 x 1220 mm.	938 x 930 x 1500 mm.	1250 x 930 x 1500 mm.	1250 x 930 x 1220 mm.
Temperatura Temperature [°C] Température	-1°C/+5°C					
Clase Climática Climatic class [°C] Classe climatique	3 / 25°C					
Tensión/Frecuencia Electrical data Tension électrique	230V/1ph/50Hz					
Controlador Controller Régulateur	Digital					
Material [EXT/INT] Matériel	Ext: acero plastificado / Plastified stainless steel / Acier plastifié Encimera / Worktop / Dessous: Inox Aisi 304 Plano exposición / Exhibition plan / Plan d'exposition: Inox Aisi 304					
Aislamiento Isolation [mm] Isolation	40kg/m ³ / Free CFC's / Zero ODP-GWP					
Capacidad Capacity [L] Capacité	150	225	300	190	253	150
Superficie exposición Surface exhibition [m ²] Surface d'exposition	0,75	1,13	1,50	1,08	1,44	0,89
Compresor Compressor [HP] Compresseur	1/3	3/4	1	3/4	1	1/3
Costados [2] Sides [2] [mm] Joues [2]	30 + 30					
Sistema de frío Cooling System Système de froid	Ventilado / Ventilated / Ventilé					
Desescarche Defrost Dégivrage	Automático / Automatic / Automatique			Gas caliente / hot gas / Gaz chaud		Automático / Automatic / Automatique
Evaporación Evaporation Évaporation	Forzada / Forced / Ventilé					
Potencia Power [W] Puissance	374	541	642	784	893	374
Potencia frig. Cooling capacity [W A -10°C] Puissance Frig.	-					
Consumo Consumption [kWh/ 24h] Consommation	6,98	10,76	12,81	12,17	14,32	7,8
Refrigerante Refrigerant Gaz	R-290					
Opcional Optional Options	Puertas correderas / Sliding doors / Portes coulissantes VEE 12 VEE 18 VEE 25			-		Puertas correderas / Sliding doors / Portes coulissantes

Laterales no incluidos en el precio
Side panels not included in price
Joues non incluses dans le prix

NEW

Series / Série **VEE - EXPERIENCE FOR EAT**

+Info: www.infrico.com

VEE25 U



Laterales / Sides / Jous

VEE CA	
Incluidos / Includes / Inclus	

Laterales / Sides / Jous

NO	
Izquierdo Left Gauche	Derecho Right Droite
U/SU:	U/SU:



VEE12 U CA

Ext. Estándar / Standar / Standard

Blanco/White/ Blanc	Ral 1015	Ral 1018
Ral 2003	Ral 3003	Ral 3020
Ral 5015	Ral 5017	Ral 5011
Ral 6002	Ral 6018	Ral 6019
Ral 7035	Ral 7037	Ral 7042
Ral 7016	Negro/Black/ Noir	

**Colores fuera de carta /
Colors outside of letter /
Couleurs spéciales, hors palette**

RAL		NO RAL	
Epoxi	Líquida/ Liquid/ Liquide	Epoxi	Líquida/ Liquid/ Liquide
[x unidad/x unit/x unité]		Consultar / Consulter / Consulter	
+10 días laborables / +10 work days / +10 jours ouvrés		Consultar / Consulter / Consulter	

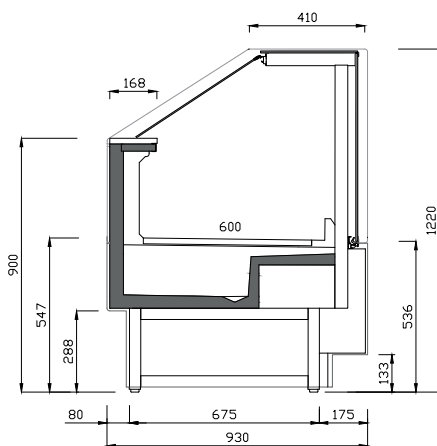

VEE U

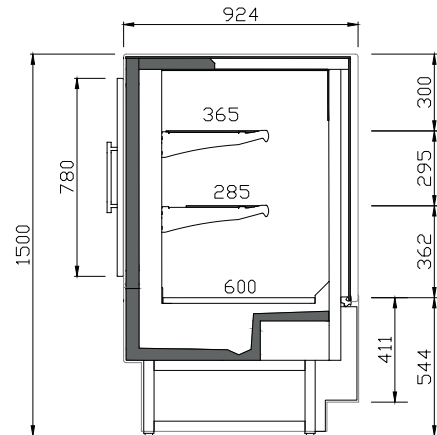

VEE U CA



+Info: www.infrico.com











+Info: www.infrico.com



Vitrina promocional grupo incorporado /
Promotional plug in counter /
Vitrine promotionnelle groupe incorporé

MODELO MODELE MODÈLE	VVS		SVS			
						
	VVS 10	VVS 12	SVS 10 E1	SVS 10 E2	SVS 12 E1	SVS 12 E2
Precio Price Prix						
Medidas Measures [mm] Mesures	938 x 1000 x 950 mm.	1250 x 1000 x 950 mm.	938 x 1000 x 1200 mm.	938 x 1000 x 1300 mm.	1250 x 1000 x 1200 mm.	1250 x 1000 x 1300 mm.
Temperatura Temperature [°C] Température	-1°C/+7°C					
Clase Climática Climatic class [°C] Classe climatique	3 / 25°C					
Tensión/Frecuencia Electrical data Tension électrique	230V/1ph/50Hz					
Controlador Controller Régulateur	Digital					
Material Material [EXT/INT] Matériel	Acero epoxi / Epoxy steel / Acier epoxy					
Aislamiento Isolation [mm] Isolation	40kg/m ³ / Free CFC's / Zero ODP-GWP					
Capacidad Capacity [L] Capacité	105	150	155	210	190	260
Superficie exposición Surface exhibition [m ²] Surface d'exposition	0,64	0,85	0,97	1,20	1,30	1,60
Compresor Compressor [HP] Compresseur	1/3	1/3	3/4	3/4	3/4	3/4
Costados [2] Sides [2] Joues [2]	-					
Sistema de frío Cooling System Système de froid	Ventilado / Ventilated / Ventilé					
Desescarche Defrost Dégivrage	Automático / Automatic / Automatique					
Evaporación Evaporation Évaporation	Forzada / Forced / Ventilé					
Potencia Power [W] Puissance	529	529	681	696	681	696
Potencia frig. Cooling capacity [W A -10°C] Puissance Frig.	-					
Consumo Consumption [kWh/ 24h] Consommation	12,7	12,7	15,1	15,4	15,1	15,4
Refrigerante Refrigerant Gaz	R-290					
Opcional Optional Options	-					

Series / Série **VISION (VVS-SVS)**

+Info: www.infrico.com

NEW

VVS 10



SVS 10E2



Laterales / Sides / Joues

Incluidos / Includes / Inclus



Islas / Horizontal freezers / Îlots congélation



FROZEN FOOD







Isla de congelación cerrada estática /
Static closed horizontal freezer /

Îlot panoramique de congélation fermé statique

Armario combi superior para isla de congelación /
Top combi cabinet for horizontal freezer /

Armoire combi supérieure pour îlot de congélation

MODELO MODELE MODÈLE	 GD21 PL1	 GD25 PL1	 GD C PL1	 AS 25 UL1
Precio Price Prix				
Medidas Measures [mm] Mesures	2100 x 980 x 1030 mm.	2500 x 980 x 1220 mm.	930 x 980 x 2100 mm.	2500 x 870 x 2385 mm.
Temperatura Temperature [°C] Température	-15°C/-18°C			
Clase Climática Climatic class [°C] Classe climatique	3 / 25°C			
Tensión/Frecuencia Electrical data Tension électrique	230V/1ph/50Hz			
Controlador Controller Régulateur	Digital			
Material [EXT/INT] Matériel	Ext: acero plastificado / Plastified stainless steel / Acier plastifié Encimera / Worktop / Dessous: Inox Aisi 304 Plano exposición / Exhibition plan / Plan d'exposition: Inox Aisi 304			
Aislamiento Isolation [mm] Isolation	40kg/m ³ / Free CFC's / Zero ODP-GWP			
Capacidad Capacity [L] Capacité	682	813	682	280
Superficie exposición Surface exhibition [m ²] Surface d'exposition	1,20	1,42	1,20	2,70
Compresor Compressor [HP] Compresseur	1 1/4	1 1/4	1 1/4	3/4
Costados [2] Sides [2] Joues [2]	-			
Sistema de frío Cooling System Système de froid	Estático / Static / Estatique			Ventilado / Ventilated / Ventilé
Desescarche Defrost Dégivrage	Automático / Automatic / Automatique			
Evaporación Evaporation Évaporation	Forzada / Forced / Ventilé			
Potencia Power [W] Puissance	1803	2042	1803	1300
Potencia frig. Cooling capacity [W A -10°C] Puissance Frig.	-			
Consumo Consumption [kWh/ 24h] Consommation	12,1	14,5	12,1	16,5
Refrigerante Refrigerant Gaz	R-290			
Opcional Optional Options	Parrilla divisoria / Divider wire / Grille de séparation			-
	Kit unión lateral / Lateral assembly kit / Kit union latérale			
	Kit unión zócalo / Base assembly kit / Kit union latérale			
	Kit unión cabecera / Header assembly kit / Kit union îlot de tête			
	Doble iluminación LED [encimera] / Double LED lighting [worktop] / Double éclairage LED [dessus]	Doble iluminación LED [encimera] / Double LED lighting [worktop] / Double éclairage LED [dessus]	-	
	Kit unión espalda / Back modules assembly kit / Kit union arrière	Kit unión espalda / Back modules assembly kit / Kit union arrière	-	

NEW

Series / Série **GD**
/ Series / Série **COMBI**

+Info: www.infrico.com

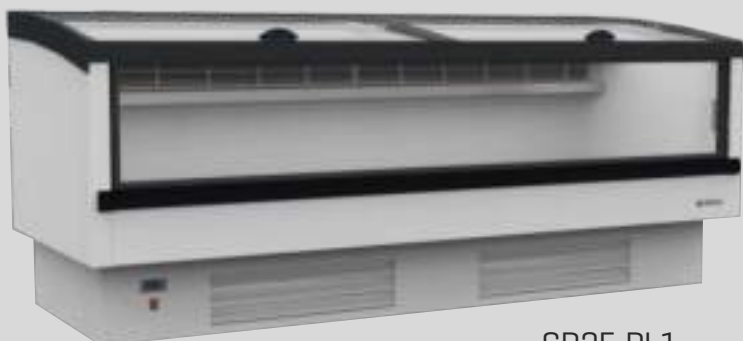

GD25 PL1

Laterales / Sides / Joes

Incluidos / Includes / Inclus

Decor. Interior / Exterior
Interior Decor./ Exterior
Décor. Intérieure / Extérieure

Ral 9016

Blanco
White
Blanc

Ral 7016

Gris antracita
Anthracite
Gris anthracite

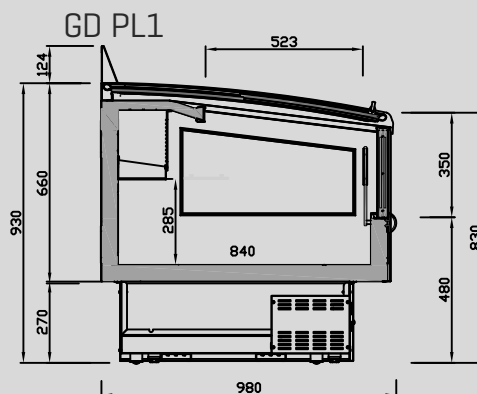
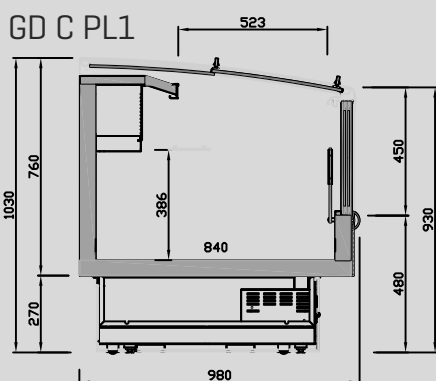

AS 25UL1

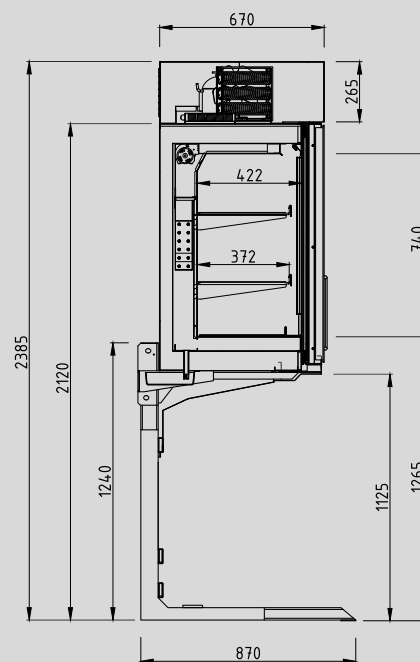

10. Murales

Multidecks / Murales





10. Murales Multidecks / Murales



+Info: www.infrico.com



10. Murales

Multidecks / Murales

Amplio rango dimensional para ofrecer la máxima capacidad.
Wide dimensional range for maximum capacity.
Une large gamme dimensionnelle pour offrir une capacité maximale.



6 625 **9** 938 **12** 1250 **18** 1875 **25** 2500 **31** 3125 **37** 3750

← Largo / Length / Longueur

S: 685 **N: 785** **L: 885** **F: 980** **X: 1085**

↙ Ancho / Width / Largeur



1075 **1500** **2000** **2200**

↑ Alto / Height / Hauteur

Máxima visibilidad de producto expuesto.
Maximum visibility of displayed product.
Visibilité maximale du produit exposé.



Iluminación / Lighting / Éclairage

Incorporación de iluminación LED, llegando a reducir el consumo energético entre un 80% y 90%, respecto a una bombilla tradicional. RGB opcional.

LED lighting incorporated, reducing energetic consumption between 80% and 90% respect to a traditional lighth bulb. RGB optional.

Éclairage LED, réduisant la consommation énergétique entre 80% et 90%, par rapport à une ampoule traditionnelle. RGB optionnel.



Rango completo de temperaturas.
Full temperature range.
Gamme de température complète.

T^a Prod. | T^a Aplic.

M0: -1/+4°C | **-1/+1°C** 🍷 🍹

M1: -1/+5°C | **0/+2°C** 🍷 🍹 🍺 🍻

M2: -1/+7°C | **+2/+4°C** 🍷 🍹 🍺 🍻

H1: +1/+10°C | **+4/+6°C** 🍷 🍹

L1: -15/-18°C | **-23/-25°C** ❄️

+Info: www.infrico.com

Estantes regulables e inclinables optimizados para cada ancho, mejorando la capacidad de carga sin reposiciones.

Adjustable and tilting shelves optimised for each width, improving load capacity without repositioning.

Des étagères réglables et inclinables optimisées pour chaque largeur, améliorant la capacité de charge sans repositionnement.



Amplias posibilidades de personalización: amplia gama de colores, laterales, accesorios...

Extensive customisation possibilities: wide range of colours, sides, accessories...

Possibilités de personnalisation étendues : large gamme de couleurs, de côtés, d'accessoires...



Puertas / Doors / Portes

SLIM

Puerta estándar de gran aislamiento
Standard door highly efficient
Porte standard très isolée

Cristales dobles templados, carga de Argón 90%, integración total, bisagras oleodinámicas, cierre automático 0-85°.

Tempered double glass, Argon charge 90%, fully integrated, oleodynamic hinges, automatic closing 0-85°.

Double vitrage trempé, charge d'Argon 90%, intégration totale, charnières oléodynamiques, fermeture automatique 0-85°.

Puertas / Doors / Portes

TOTAL LOOK

Cristal doble completamente transparente
Fully transparent double glass door
Porte en verre double entièrement transparente

Cristales dobles templados, carga de Argón 90%, integración total, bisagras oleodinámicas, cierre automático 0-85°.

Tempered double glass, Argon charge 90%, fully integrated, oleodynamic hinges, automatic closing 0-85°.

Double vitrage trempé, charge d'Argon 90%, intégration totale, charnières oléodynamiques, fermeture automatique 0-85°.

10. Murales

Multidecks / Murales

Régimen de temperaturas / Temperature range / Régime de températures (ISO23953)

Tª Prod. | Tª Aplic.
M0: -1/+4°C | -1/+1°C

 Carne / Meat / Viande

 Pescado / Fish / Poisson

Tª Prod. | Tª Aplic.
M1: -1/+5°C | 0/+2°C

 Carne / Meat / Viande

 Pescado / Fish / Poisson

 4ª Gama / 4TH Range / 4ème Gamme

 Comida preparada / Grab & Go / Plats préparés

Tª Prod. | Tª Aplic.
M2: -1/+7°C | +2/+4°C

 Charcutería / Deli / Charcuterie

 Bebidas / Cold drinks / Boissons

 Lacteos / Dairy / Laitiers

Tª Prod. | Tª Aplic.
H1: +1/+10°C | +4/+6°C

 Lacteos / Dairy / Laitiers

 Frutas y verduras
Fruit vegetables

 Fruits et légumes

Tª Prod. | Tª Aplic.
L1: -15/-18°C | -23/-25°C

 Congelados

Frozen foods

Prod. Surgelés

Puertas / Doors / Portes

Total Look

Cristal doble completamente transparente

Fully transparent double glass door

Porte en verre double entièrement transparente



Cristales dobles templados, carga de Argón 90%, integración total, bisagras oleodinámicas, cierre automático 0-85°.

Tempered double glass, Argon charge 90%, fully integrated, oleodynamic hinges, automatic closing 0-85°.

Double vitrage trempé, charge d'Argon 90%, intégration totale, charnières oléodynamiques, fermeture automatique 0-85°.

Slim

Puerta estándar de gran aislamiento

Standard door highly efficient

Porte standard très isolée



Iluminación LED / LED lighting / Éclairage LED

Los sistemas de iluminación de Infrico te ayudan a dar la máxima visibilidad del producto manteniendo su frescura y conservación.

Infrico's lighting systems help you to give maximum product visibility while maintaining freshness and preservation.

Les systèmes d'éclairage d'Infrico vous permettent d'offrir une visibilité maximale du produit tout en maintenant la fraîcheur et la conservation.

24V, Led vertical IP65, Led visera IP54, plug and play, temp. de color de 3000-4000-6000K en función del producto.

24V, IP65 vertical LED, IP54 visor LED, plug and play, colour temperature 3000-4000-6000K depending on the product.

24V, LED verticale IP65, LED de visière IP54, plug and play, température de couleur 3000-4000-6000K selon le produit.



10. Murales

Multidecks / Murales

Características generales	346 - 349
General features	
Caractéristiques générales	

SEMIMURALES / LOW MULTIDECK DISPLAY CASES / SEMI MURALES

Serie / Series / Série

SMDG SMPB (EDIMBURGO)	Semimural abierta y cerrada refrigerada grupo remoto Open and close refrigeration low multideck remote group Semi murale de réfrigération ouverte et fermée groupe à distance	356 - 357
--------------------------------------	--	------------------

Serie / Series / Série

SMDCP (DUBLIN)	Semimural plug in de refrigeración cerrada Plug in refrigeration doors low multideck Semi murale de réfrigération fermée groupe incorporé	358 - 359
---------------------------	--	------------------

Serie / Series / Série

SMP (GLASGOW)	Semimural plug in de refrigeración bierta Open doors plug in refrigeration low multideck Semi murale de réfrigération ouverte groupe incorporé	360 - 361
--------------------------	---	------------------

Serie / Series / Série

VEG (ELEGANCE)	Semimural plug in R-290 de refrigeración abierta, estética vitrina Closed plug in refrigeration low multideck, aesthetically display case Semi murale de réfrigération R-290 groupe incorporé, esthétique vitrine	362 - 363
---------------------------	--	------------------

MURALES / VERTICAL MULTIDECK DISPLAY CASES / VITRINES MURALES

Serie / Series / Série

MDCP (ROTTERDAM)	Mural plug in de refrigeración cerradas Plug in R-290 refrigeration doors multidecks Murale de réfrigération fermée groupe incorporé R-290	366 - 371
-----------------------------	---	------------------

Serie / Series / Série

NEW MP (MUNICH)	Mural plug in de refrigeración abierta Plug in R-290 refrigeration open multidecks Murale de réfrigération ouverte groupe incorporé R-290	372 - 377
----------------------------	--	------------------

Serie / Series / Série

NEW MSBA (OPORTO) MSDCBA (ORLEANS)	Mural plug in Experience para quesos y bacalao Plug in R-290 Experience multidecks for cheese and codfish Murale Experience de réfrigération groupe incorporé R-290 pour le fromage et la morue	378 - 379
---	--	------------------

Serie / Series / Série

NEW MDR (RIMINI)	Mural remota de refrigeración cerrada frente medio Remote refrigeration doors middle front multideck Murale de réfrigération fermée groupe à distance front moyenne	380 - 383
-----------------------------	--	------------------

Serie / Series / Série

MDG (PORTLAND)	Mural remota de refrigeración cerradas Remote refrigeration doors multidecks Murale de réfrigération fermée groupe à distance	384 - 397
---------------------------	--	------------------

Serie / Series / Série

MDGU (DETROIT)	Mural mixta de refrigeración cerradas Mixed refrigeration doors multidecks Murales mixtes de réfrigération fermée	398 - 405
---------------------------	--	------------------

+Info: www.infrico.com

Serie / Series / Série

SMDG
SMPB



SMDG SML [12-18-25-31] DG (M1-M2)



SMPB SML [12-18-25-31] PB (M1-M2)

Serie / Series / Série

SMDCP



SMDCP SMS-SML [12-18-25] DCP-DCPC (M1-M2)

Serie / Series / Série

SMP



SMP SMS-SML [6-9-12-18] P-PC (M2)

Serie / Series / Série

VEG
ELEGANCE



VEG VEG [9-12-15-18]

Serie / Series / Série

MDCP



MDCP MS-MN-ML [9-12-18-25] DCP-DCPC (M1-M2-H1)
MS-MN-ML [9-12-18] DCPI (M1-M2)

Serie / Series / Série

MP



MP MS-MN-ML [6-9-12-18-25] P-PC (M1-M2-H1)
MS-MN-ML [6-9-12-18] PI (M1-M2)

Serie / Series / Série

MSBA
MSDCBA



NEW MS [9-12] BA (M1)
MS [9-12] DC BA (M1)

Serie / Series / Série

MDR



NEW MN [12-18-25-37] DR (M1-M2-H1)
ML [12-18-25-31-37] DR (M1-M2-H1)

Serie / Series / Série

MDG



NEW MS-MN-MN22-ML-ML22-MX-MX22 [12-18-25-37] DG (M0-M1-M2-H1)

Serie / Series / Série

MDGU



NEW MS-MN-ML-ML22 [12-18-25-37] DGU (M1-M2-H1)

10. Murales

Multidecks / Murales

Serie / Series / Série

**MPB
(OSLO)**

Mural remota de refrigeración abierta frente bajo

Remote refrigeration open low front multidecks

Murale de réfrigération ouverte groupe à distance avec frontal bas

406 - 417

Serie / Series / Série

**MBT
(TORONTO)**

Mural remota de congelación cerrada

Remote freezer full glass doors multidecks

Murale congelation fermée groupe à distance

418 - 421

Serie / Series / Série

**MBTU
(MONTREAL)**

Mural mixta de congelación cerrada

Mixed freezer full glass doors multidecks

Murale mixte de congelation fermée groupe à distance

422 - 423

Serie / Series / Série

**MBTP
(VANCOUVER)**

Mural plug in de congelación cerrada

Plug in freezer full glass doors multideck

Murale congelation fermée groupe incorporé

424 - 425

Serie / Series / Série

OPCIONES

OPTIONS

OPTIONS

426 - 427

MOTOCONDENSADORAS / CONDENSING UNITS / MOTOCONDENSATEURS

Serie / Series / Série

**SIGILUS
INTARBOX
WATERLOOP**

Motocondensadoras

Condensing units

Motocondensateurs

428 - 435

CENTRALES FRIGORÍFICAS / REFRIGERATION UNITS / CENTRALES FRIGORIFIQUES

Serie / Series / Série

INTARCUBE

Centrales frigoríficas

Refrigeration units

Centrales frigorifiques

436 - 437

+Info: www.infrico.com

Serie / Series / Série
MPB  **MN-MN22-ML-ML22 [9-12-18-25-37] PB (M1-M2-H1)**
MX-MX22 [9-12-18-25-37] PB (M2-H1)

Serie / Series / Série
MBT  **NEW** **MN-MN22-MF-MF22 [2P-3P-4P-5P] BT (L1)**

Serie / Series / Série
MBTU  **NEW** **MN [2P-3P] BTU (L1)**

Serie / Series / Série
MBTP  **MN [12-18-25] BTP-BTPC (L1)**

Serie / Series / Série
SIGILUS
INTARBOX
WATERLOOP
INTARCUBE



**SEMIMURALES /
LOW MULTIDECK DISPLAY CASES /
VITRINES SEMI MURALES**



Semimural abierta y cerrada refrigerada grupo remoto

Open and close refrigeration low multideck remote group

Semi murale de réfrigération ouverte et fermée groupe à distance



	SMDG				SMPB																					
MODELO MODELE MODÈLE																										
Precio Price Prix	M1																									
MOD.	SML12 DG M2	SML18 DG M2	SML25 DG M2	SML37 DG M2	SML12 PB M2	SML18 PB M2	SML25 PB M2	SML37 PB M2																		
Precio Price Prix	M2																									
Medidas / Mesures / Mesures / [mm] Sin costados / Without sides / Sans joues	1250 x 904 x 1500 mm.	1875 x 904 x 1500 mm.	2500 x 904 x 1500 mm.	3750 x 904 x 1500 mm.	1250 x 904 x 1500 mm.	1875 x 904 x 1500 mm.	2500 x 904 x 1500 mm.	3750 x 904 x 1500 mm.																		
T°. Prod. Aplic. Prod. T°. Applic. T°. (°C) Temp. Prod. Temp. Applic.	M1: -1/+5°C 0/+2°C M2: -1/+7°C +2/+4°C																									
Clase Climática Climatic class (°C) Classe climatique	3 / 25°C																									
Tensión/Frecuencia Electrical data Tension électrique	230V/1ph/50Hz																									
Controlador Controller Régulateur	Digital																									
Material Material Matériel [EXT/INT]	Acero galvanizado plastificado / Plastified galvanised steel / Acier galvanisé plastifié																									
Aislamiento Isolation Isolation [mm]	40kg/m ³ / Free CFC's / Zero ODP-GWP																									
Capacidad Capacity Capacité [L]	486	729	973	1459	486	729	973	1459																		
Superficie exposición Surface exhibition [x m²] Surface d'exposition	1,17	1,76	2,34	3,52	1,49	2,23	2,97	4,46																		
Niveles Exposición Exposition Levels Niveaux d'exposition	3+Expos.																									
Costados [2] Sides [2] Joues [2] [mm]	40 + 40																									
Sistema de frío Cooling System Système de froid	Ventilado / Ventilated / Ventilé																									
Desescarche Defrost Dégivrage	Automático / Automatic / Automatique																									
Evaporación Evaporation Évaporation	Forzada / Forced / Ventilé																									
Potencia Power Puissance [W]	M1 80,5 M2 80,5	M1 121 M2 121	M1 161 M2 161	M1 242 M2 242	M1 80,5 M2 80,5	M1 121 M2 121	M1 161 M2 161	M1 242 M2 242																		
Potencia frig. Cooling capacity Puissance Frig. [W A -10°C]	M1 446 M2 338	M1 669 M2 581	M1 1339 M2 1163	M1 2121 M2 1803	M1 3188 M2 2704	M1 4243 M2 3605	M1 6364 M2 5408	M1 5438 M2 4624																		
Consumo Consumption Consommation [kWh/ 24h]	M1 1,35 M2 1,35	M1 2,03 M2 2,03	M1 2,70 M2 2,70	M1 4,06 M2 4,06	M1 1,35 M2 1,35	M1 2,03 M2 2,03	M1 2,70 M2 2,70	M1 4,06 M2 4,06																		
Refrigerante Refrigerant Gaz	FREON																									
Laterales / Sides / Joues No Incluidos / Not includes / Non inclus																										
Colores estándar Standar colors Couleurs standard	Int. Estándar / Standar / Standard <table border="1"> <tr> <td>Blanco/White/ Blanc</td> <td>Negro/Black/ Noir</td> <td>Ral 7016</td> </tr> </table>								Blanco/White/ Blanc	Negro/Black/ Noir	Ral 7016															
Blanco/White/ Blanc	Negro/Black/ Noir	Ral 7016																								
Laterales disponibles Available sides Joues disponibles	Ext. Estándar / Standar / Standard <table border="1"> <tr> <td>Blanco/White/ Blanc</td> <td>Ral 1015</td> <td>Ral 1018</td> </tr> <tr> <td>Ral 2003</td> <td>Ral 3003</td> <td>Ral 3020</td> </tr> <tr> <td>Ral 5015</td> <td>Ral 5017</td> <td>Ral 5011</td> </tr> <tr> <td>Ral 6002</td> <td>Ral 6018</td> <td>Ral 6019</td> </tr> <tr> <td>Ral 7035</td> <td>Ral 7037</td> <td>Ral 7042</td> </tr> <tr> <td>Ral 7016</td> <td>Ral 9006</td> <td>Negro/Black/ Noir</td> </tr> </table>								Blanco/White/ Blanc	Ral 1015	Ral 1018	Ral 2003	Ral 3003	Ral 3020	Ral 5015	Ral 5017	Ral 5011	Ral 6002	Ral 6018	Ral 6019	Ral 7035	Ral 7037	Ral 7042	Ral 7016	Ral 9006	Negro/Black/ Noir
Blanco/White/ Blanc	Ral 1015	Ral 1018																								
Ral 2003	Ral 3003	Ral 3020																								
Ral 5015	Ral 5017	Ral 5011																								
Ral 6002	Ral 6018	Ral 6019																								
Ral 7035	Ral 7037	Ral 7042																								
Ral 7016	Ral 9006	Negro/Black/ Noir																								
Opciones pág. 426-427 Options pages 426-427 Options pages 426-427																										
	<p>Lateral Espejo Mirror end panels Joue Miroir</p>		<p>Lateral Panorámico Panoramic end panels Joue panoramique</p>		<p>Lateral Display Display end panels Joue Display</p>																					

Serie / Series / Série **SMDG (EDIMBURGO)**
 Serie / Series / Série **SMPB (EDIMBURGO)**

+Info: www.infrico.com

SML25DG



SML25PB

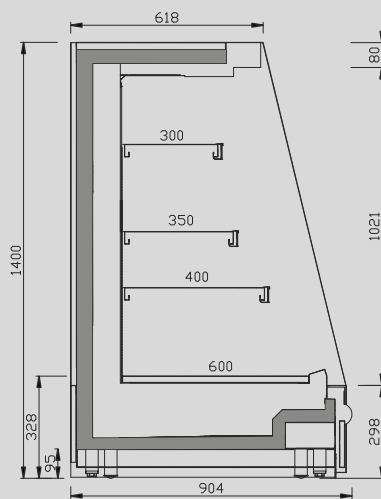

SML PB

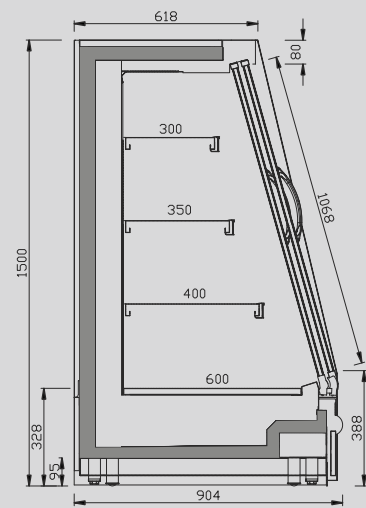

SML DG



Semimural plug in de refrigeración cerradas

Plug in refrigeration doors low multideck

Semi murale de réfrigération fermée groupe incorporé



MODELO MODELE MODÈLE						
Precio Price Prix	M1					
MOD.	SMS12 DCPC M1	SMS18 DCPC M1	SMS25 DCPC M1	SML12 DCPC M1	SML18 DCPC M1	SML25 DCPC M1
Precio Price Prix	C M1					
MOD.	SMS12 DCP M2	SMS18 DCP M2	SMS25 DCP M2	SML12 DCP M2	SML18 DCP M2	SML25 DCP M2
Precio Price Prix	M2					
MOD.	SMS12 DCPC M2	SMS18 DCPC M2	SMS25 DCPC M2	SML12 DCPC M2	SML18 DCPC M2	SML25 DCPC M2
Precio Price Prix	C M2					
Medidas / Mesures / Mesures / [mm] Sin costados / Without sides / Sans joues	1250 x 685 x 1500 mm.	1875 x 685 x 1500 mm.	2500 x 685 x 1500 mm.	1250 x 885 x 1500 mm.	1875 x 885 x 1500 mm.	2500 x 885 x 1500 mm.
T°. Prod. Aplic. Prod. T°. Applic. T°. (°C) Temp. Prod. Temp. Appliq.	M1: -1/+5°C 0/+2°C M2: -1/+7°C +2/+4°C					
Clase Climática Climatic class (°C) Classe climatique	3 / 25°C					
Tensión/Frecuencia Electrical data Tension électrique	230V/1ph/50Hz					
Controlador Controller Régulateur	Digital					
Material Material (EXT/INT) Matériel	Acero galvanizado plastificado / Plastified galvanised steel / Acier galvanisé plastifié					
Aislamiento Isolation [mm] Isolation	40kg/m ³ / Free CFC's / Zero ODP-GWP					
Capacidad Capacity [L] Capacité	263	396	528	345	518	690
Superficie exposición Surface exhibition [x m ²] Surface d'exposition	1,14	1,72	2,08	1,20	2,10	2,80
Niveles Exposición Exposition Levels Niveaux d'exposition	3+Expos.					
Costados (2) Sides (2) [mm] Joues (2)	40 + 40					
Puertas Doors Portes	2		4		2	4
Sistema de frío Cooling System Système de froid	Ventilado / Ventilated / Ventilé					
Desescarche Defrost Dégivrage	Automático / Automatic / Automatique					
Evaporación Evaporation Évaporation	Forzada / Forced / Ventilé					
Potencia Power [W] Puissance	M1 537 M2 537	M1 725 M2 725	M1 1116 M2 1116	M1 537 M2 537	M1 700 M2 700	M1 1116 M2 1116
Potencia frig. Cooling capacity [W A -10°C] Puissance Frig.	-					
Consumo Consumption [kWh/ 24h] Consommation	M1 8,18 M2 7,87	M1 10,7 M2 10,3	M1 15,1 M2 14,1	M1 8,93 M2 7,87	M1 11,0 M2 10,3	M1 15,8 M2 15,3
Refrigerante Refrigerant Gaz	R-290					
Colores estándar Standard colors Couleurs standard	Ext. Estándar / Standar / Standard			Laterales / Sides / Joues		
	Blanco/White/ Blanc	Ral 1015	Ral 1018	No Incluidos / Not includes / Non inclus		
	Ral 2003	Ral 3003	Ral 3020			
Laterales disponibles Available sides Joues disponibles	Ral 5015	Ral 5017	Ral 5011	Int. Estándar / Standar / Standard		
	Ral 6002	Ral 6018	Ral 6019	Blanco/White/ Blanc	Negro/Black/ Noir	Ral 7016
	Ral 7035	Ral 7037	Ral 7042			
Opciones pág. 426-427 Options pages 426-427 Options pages 426-427	Ral 7016	Ral 9006	Negro/Black/ Noir			

Serie / Series / Série **SMDCP (DUBLÍN)**

+Info: www.infrico.com

SML25DCP

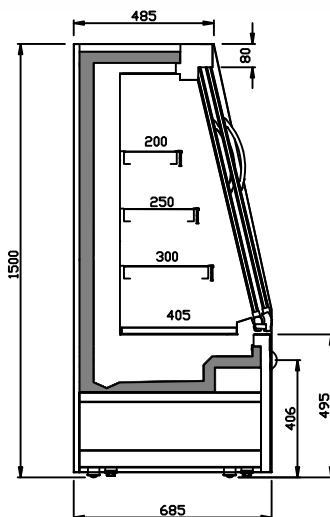

SMS DCP

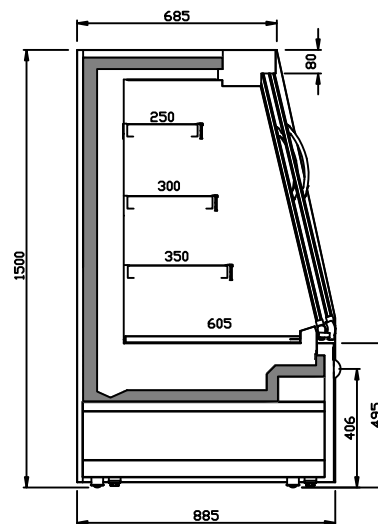

SML DCP

SMS12DCP





Semimural plug in de refrigeración abiertas

Plug in refrigeration open low multideck

Semi murale de réfrigération ouverte groupe incorporé



MODELO MODEL MODÈLE	SMS					SML				
	SMS6 P M2	SMS9 P M2	SMS12 P M2	SMS18 P M2	SMS25 P M2	SML6 P M2	SML9 P M2	SML12 P M2	SML18 P M2	SML25 P M2
Precio Price Prix	M2									
MOD.	SMS6 PC M2	SMS9 PC M2	SMS12 PC M2	SMS18 PC M2	SMS25 PC M2	SML6 PC M2	SML9 PC M2	SML12 PC M2	SML18 PC M2	SML25 PC M2
Precio Price Prix	C M2									
Medidas / Mesures / Mesures / [mm] Sin costados / Without sides / Sans joues	625 x 685 x 1500 mm.	938 x 685 x 1500 mm.	1250 x 685 x 1500 mm.	1875 x 685 x 1500 mm.	2500 x 685 x 1500 mm.	625 x 885 x 1500 mm.	938 x 885 x 1500 mm.	1250 x 885 x 1500 mm.	1875 x 885 x 1500 mm.	2500 x 885 x 1500 mm.
T° Prod. Aplic. Prod. T° Applic. T°. (°C) Temp. Prod. Temp. Applic.	M2: -1/+7°C +2/+4°C									
Clase Climática Climatic class (°C) Classe climatique	3 / 25°C									
Tensión/Frecuencia Electrical data Tension électrique	230V/1ph/50Hz									
Controlador Controller Régulateur	Digital									
Material Material Matériel [EXT/INT]	Acero galvanizado plastificado / Plastified galvanised steel / Acier galvanisé plastifié									
Aislamiento Isolation Isolation [mm]	40kg/m ³ / Free CFC's / Zero ODP-GWP									
Capacidad Capacity Capacité [L]	63	95	127	190	253	179	269	358	537	716
Superficie exposición Surface exhibition Surface d'exposition [x m ²]	0,82	1,22	1,63	2,45	3,26	0,94	1,41	1,88	2,82	3,76
Niveles Exposición Exposition Levels Niveaux d'exposition	3+Expos.									
Costados (2) Sides (2) Joues (2) [mm]	40 + 40									
Puertas Doors Portes	-									
Sistema de frío Cooling System Système de froid	Ventilado / Ventilated / Ventilé									
Desescarche Defrost Dégivrage	Automático / Automatic / Automatique									
Evaporación Evaporation Évaporation	Forzada / Forced / Ventilé									
Potencia Power Puissance [W]	461	599	609	1031	1331	461	599	609	1031	1331
Potencia frig. Cooling capacity Puissance Frig. [W A -10°C]	-									
Consumo Consumption Consommation [kWh/ 24h]	7,2	9,6	9,8	10,1	18,5	7,6	11,2	11,8	16,3	19,0
Refrigerante Refrigerant Gaz	R-290									
Colores estándar Standar colors Couleurs standard	Int. Estándar / Standar / Standard Blanco/White/ Blanc Negro/Black/ Noir Ral 7016			Laterales / Sides / Joues No Incluidos / Not includes / Non inclus						
Laterales disponibles Available sides Joues disponibles	Ext. Estándar / Standar / Standard Blanco/White/ Blanc Ral 1015 Ral 1018 Ral 2003 Ral 3003 Ral 3020 Ral 5015 Ral 5017 Ral 5011 Ral 6002 Ral 6018 Ral 6019 Ral 7035 Ral 7037 Ral 7042 Ral 7016 Ral 9006 Negro/Black/ Noir			 Lateral Espejo Mirror end panels Joue Miroir						
Opciones pág. 426-427 Options pages 426-427 Options pages 426-427	 Lateral Display Display end panels Joue Display									

Serie / Series / Série **SMP (GLASGOW)**

+Info: www.infrico.com

SMS18P C



**Nuevo
paragolpes
frontal**

**New
front
bumper**

**Nouveau
pare-chocs
frontale**



SML18P

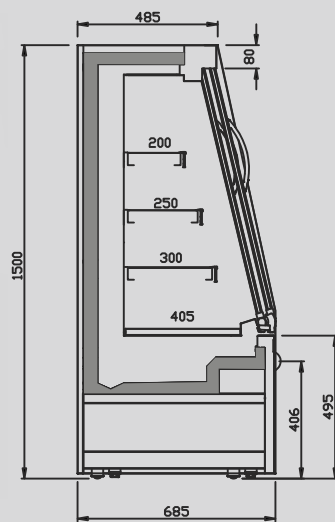

SMS P

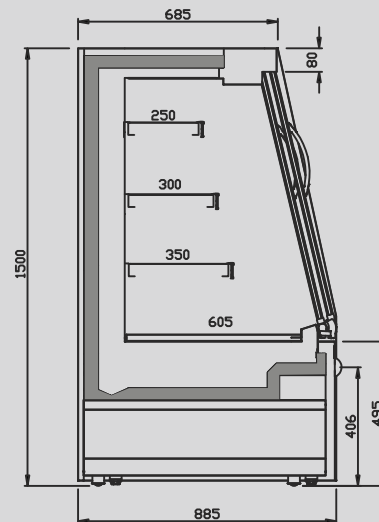





SML P



Semimural plug in R-290 de refrigeración abierta, estética vitrina

Closed plug in refrigeration low multideck, aesthetically display case

Semi murale de réfrigération R-290 groupe incorporé, esthétique vitrine

MODELO MODELE MODÈLE				
Precio Price Prix	U			
MOD.	VEG9IU	VEG12IU	VEG15IU	VEG18IU
Precio Price Prix	IU			
Medidas Measures Mesures (mm)	938 x 1075 x 1260 mm.	1250 x 1075 x 1260 mm.	1562 x 1075 x 1260 mm.	1875 x 1075 x 1260 mm.
T°. Prod. Aplic. Prod. T°. Applic. T°. (°C) Temp. Prod. Temp. Appliq.	M2: -1/+7°C +2/+4°C			
Clase Climática Climatic class Classe climatique (°C)	3 / 25°C			
Tensión/Frecuencia Electrical data Tension électrique	230V/1ph/50Hz			
Controlador Controller Régulateur	Digital			
Material Material Matériel (EXT/INT)	Ext/Int: Acero galvanizado plastificado / Plastified galvanised steel / Acier galvanisé plastifié Int: Inox AISI 304 (mod. I)			
Aislamiento Isolation Isolation (mm)	40kg/m ³ / Free CFC's / Zero ODP-GWP			
Capacidad Capacity Capacité (L)	316	425	531	638
Superficie exposición Surface exhibition Surface d'exposition (x m ²)	0,83	1,12	1,39	1,67
Compresor Compressor Compresseur (HP)	3/4	3/4	1	1+1/4
Estantes Shelving Étagères	-			
Costados (2) Sides (2) Joues (2) (mm)	30+30			
Sistema de frío Cooling System Système de froid	Ventilado / Ventilated / Ventilé			
Desescarche Defrost Dégivrage	Automático / Automatic / Automatique			
Evaporación Evaporation Évaporation	Forzada / Forced / Ventilé			
Potencia Power Puissance (W)	595	741	838	1229
Potencia frig. Cooling capacity Puissance Frig. (W A -10°C)	-			
Consumo Consumption Consommation (kWh/ 24h)	7,85	9,8	11,1	14,8
Refrigerante Refrigerant Gaz	R-290			
Colores estándar Standar colors Couleurs standard	Int. Estándar / Standar / Standard Blanco/White/ Blanc Negro/Black/ Noir		Laterales / Sides / Joues No Incluidos / Not includes / Non inclus	
Laterales disponibles Available sides Joues disponibles	Ext. Estándar / Standar / Standard Blanco/White/ Blanc Ral 1001 Ral 1018 Ral 2003 Ral 3003 Ral 3020 Design 2108025 Ral 5015 Ral 4007 Ral 6002 Design 1107060 Design 3504035 Ral 9006 Ral 7016 Ral 8017			
Opciones pág. 426-427 Options pages 426-427 Options pages 426-427				

Serie / Series / Série **VEG (ELEGANCE)**

+Info: www.infrico.com

VEG18



VEG15

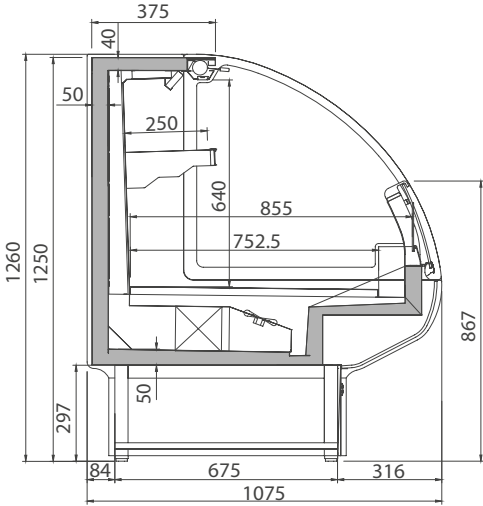

VEG



**MURALES /
VERTICAL MULTIDECK DISPLAY CASES /
MURALES**







Mural plug in de refrigeración cerrada

Plug in refrigeration doors multidecks

Murale de réfrigération fermée groupe incorporé

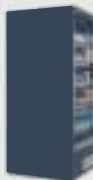

MODELO MODELÉ MODÈLE					
Precio Price Prix	M1 / C M1				
MOD.	MS6 DCP M2 / DCPC M2 MS9 DCP M2 / DCPC M2 MS12 DCP M2 / DCPC M2 MS18 DCP M2 / DCPC M2 MS25 DCP M2 / DCPC M2				
Precio Price Prix	M2 / C M2				
MOD.	- MS9 DCP H1 / DCPC H1 MS12 DCP H1 / DCPC H1 MS18 DCP H1 / DCPC H1 MS25 DCP H1 / DCPC H1				
Precio Price Prix	H1 / C H1				
MOD.	- MS9 DCPI M1 / DCPI M2 MS12 DCPI M1 / DCPI M2 MS18 DCPI M1 / DCPI M2 -				
Precio Price Prix	INOX M1 / M2				
Medidas Measures (mm) Mesures	625 x 685 x 2000 mm.	938 x 685 x 2000 mm.	1250 x 685 x 2000 mm.	1875 x 685 x 2000 mm.	2500 x 685 x 2000 mm.
Tª. Prod. Aplic. Prod. Tª. Applic. Tª. (°C) Temp. Prod. Temp. Appliq.	M1: -1/+5°C 0/+2°C M2: -1/+7°C +2/+4°C H1: +1/+10°C +4/+6°C				
Clase Climática Climatic class (°C) Classe climatique	3 / 25°C				
Tensión/Frecuencia Electrical data Tension électrique	230V/1ph/50Hz				
Controlador Controller Régulateur	Digital				
Material Material [EXT/INT] Matériel	Acero galvanizado plastificado / Plastified galvanised steel / Acier galvanisé plastifié				
Aislamiento Isolation (mm) Isolation	40kg/m³ / Free CFC's / Zero ODP-GWP				
Capacidad Capacity (L) Capacité	M1, M2: 230 H1: 184	M1, M2: 341 H1: 278	M1, M2: 455 H1: 370	M1, M2: 683 H1: 555	M1, M2: 910 H1: 740
Superficie exposición Surface exhibition (x m²) Surface d'exposition	M1, M2: 0,80 H1: 0,80	M1, M2: 1,11 H1: 1,11	M1, M2: 1,45 H1: 1,45	M1, M2: 2,17 H1: 2,17	M1, M2: 2,90 H1: 2,90
Niveles Exposición Exposition Levels Niveaux d'exposition	M1-M2: 4+Expos. H1: 3+Expos.				
Costados [2] Sides [2] (mm) Joues [2]	40 + 40				
Puertas Doors Portes	1	2	2	3	4
Sistema de frío Cooling System Système de froid	Ventilado / Ventilated / Ventilé				
Desescarche Defrost Dégivrage	Automático / Automatic / Automatique				
Evaporación Evaporation Evaporation	Forzada / Forced / Ventilé				
Potencia Power (W) Puissance	M1: 539 M2: 539 H1: 539	M1: 626 M2: 672 H1: 672	M1: 714 M2: 770 H1: 770	M1: 837 M2: 899 H1: 899	M1: 2164 M2: 2374 H1: 2374
Potencia frig. Cooling capacity (W A -10°C) Puissance Frig.	-				
Consumo Consumption (kWh/24h) Consommation	M1: 7,86 M2: 6,88 H1: 5,99	M1: 8,89 M2: 7,97 H1: 7,27	M1: 9,88 M2: 8,79 H1: 8,62	M1: 12,81 M2: 11,14 H1: 10,74	M1: 17,10 M2: 15,64 H1: 14,08
Refrigerante Refrigerant Gaz	R-290				
Colores estándar Standar colors Couleurs standard	Ext. Estándar / Standar / Standard		Laterales / Sides / Joues		
	Blanco/White/ Blanc	Ral 1015 Ral 1018	No incluidos / Not includes / Non inclus		
	Ral 2003	Ral 3003 Ral 3020			
Laterales disponibles Available sides Joues disponibles	Ral 5015	Ral 5017 Ral 5011	Int. Estándar / Standar / Standard		
	Ral 6002	Ral 6018 Ral 6019	Blanco/White/ Blanc		
	Ral 7035	Ral 7037 Ral 7042	Negro/Black/ Noir		
	Ral 7016	Ral 9006 Negro/Black/ Noir	Ral 7016		
Opciones pág. 426-427 Options pages 426-427 Options pages 426-427			 		

Serie / Series / Série **MDCP (ROTTERDAM)**

+Info: www.infrico.com

MS25 DCPC M2



MS18 DCPI M1

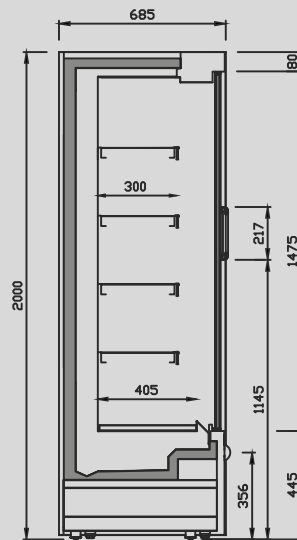

MS DCP M1/M2

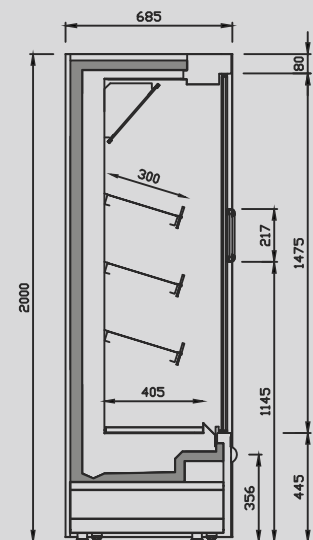

MS DCP H1



Mural plug in de refrigeración cerrada

Plug in refrigeration doors multidecks

Murale de réfrigération fermée groupe incorporé

N: 785

MODELO MODEL MODÈLE				
Precio Price Prix	M1 / C M1			
MOD.	MN9 DCP M2 / DCPC M2	MN12 DCP M2 / DCPC M2	MN18 DCP M2 / DCPC M2	MN25 DCP M2 / DCPC M2
Precio Price Prix	M2 / C M2			
MOD.	MN9 DCP H1 / DCPC H1	MN12 DCP H1 / DCPC H1	MN18 DCP H1 / DCPC H1	MN25 DCP H1 / DCPC H1
Precio Price Prix	H1 / C H1			
MOD.	MN9 DCPI M1 / DCPI M2	MN12 DCPI M1 / DCPI M2	MN18 DCPI M1 / DCPI M2	-
Precio Price Prix	INOX M1 / M2			
Medidas Measures Mesures (mm)	938 x 785 x 2000 mm.	1250 x 785 x 2000 mm.	1875 x 785 x 2000 mm.	2500 x 785 x 2000 mm.
T°. Prod. Aplic. Prod. T° Applic. T°. (°C) Temp. Prod. Temp. Appliq.	M1: -1/+5°C 0/+2°C M2: -1/+7°C +2/+4°C H1: +1/+10°C +4/+6°C			
Clase Climática Climatic class Classe climatique (°C)	3 / 25°C			
Tensión/Frecuencia Electrical data Tension électrique	230V/1ph/50Hz			
Controlador Controller Régulateur	Digital			
Material Material Matériel (EXT/INT)	Acero galvanizado plastificado / Plastified galvanised steel / Acier galvanisé plastifié			
Aislamiento Isolation Isolation (mm)	40kg/m ³ / Free CFC's / Zero ODP-GWP			
Capacidad Capacity Capacité (L)	M1, M2: 394 H1: 319	M1, M2: 526 H1: 426	M1, M2: 789 H1: 639	M1, M2: 1053 H1: 852
Superficie exposición Surface exhibition Surface d'exposition (x m ²)	M1, M2: 1,97 H1: 1,60	M1, M2: 2,63 H1: 2,10	M1, M2: 3,95 H1: 3,20	M1, M2: 5,30 H1: 4,20
Niveles Exposición Exposition Levels Niveaux d'exposition	M1-M2: 4+Expos. H1: 3+Expos.			
Costados [2] Sides [2] Joues [2] (mm)	40 + 40			
Puertas Doors Portes	2	2	3	4
Sistema de frío Cooling System Système de froid	Ventilado / Ventilated / Ventilé			
Desescarche Defrost Dégivrage	Automático / Automatic / Automatique			
Evaporación Evaporation Evaporation	Forzada / Forced / Ventilé			
Potencia Power Puissance (W)	M1: 626 M2: 672 H1: 672	M1: 714 M2: 770 H1: 770	M1: 837 M2: 899 H1: 899	M1: 1192 M2: 1297 H1: 1297
Potencia frig. Cooling capacity Puissance Frig. (W A -10°C)	-			
Consumo Consumption Consommation (kWh/24h)	M1: 8.09 M2: 7.54 H1: 6.07	M1: 8.99 M2: 8.38 H1: 7.10	M1: 15.59 M2: 9.53 H1: 8.57	M1: 16.56 M2: 14.91 H1: 13.41
Refrigerante Refrigerant Gaz	R-290			
Colores estándar Standard colors Couleurs standard	Ext. Estándar / Standar / Standard		Laterales / Sides / Joues	
	Blanco/White/ Blanc	Ral 1015 Ral 1018	No incluidos / Not includes / Non inclus	
	Ral 2003	Ral 3003 Ral 3020		
Laterales disponibles Available sides Joues disponibles	Ral 5015	Ral 5017 Ral 5011	Int. Estándar / Standar / Standard	
	Ral 6002	Ral 6018 Ral 6019	Blanco/White/ Blanc	
	Ral 7035	Ral 7037 Ral 7042	Negro/Black/ Noir	
	Ral 7016	Ral 9006 Negro/Black/ Noir	Ral 7016	
Opciones pág. 426-427 Options pages 426-427 Options pages 426-427				

Serie / Series / Série **MDCP (ROTTERDAM)**

+Info: www.infrico.com

MN25 DCPC M2



MN25 DCP H1

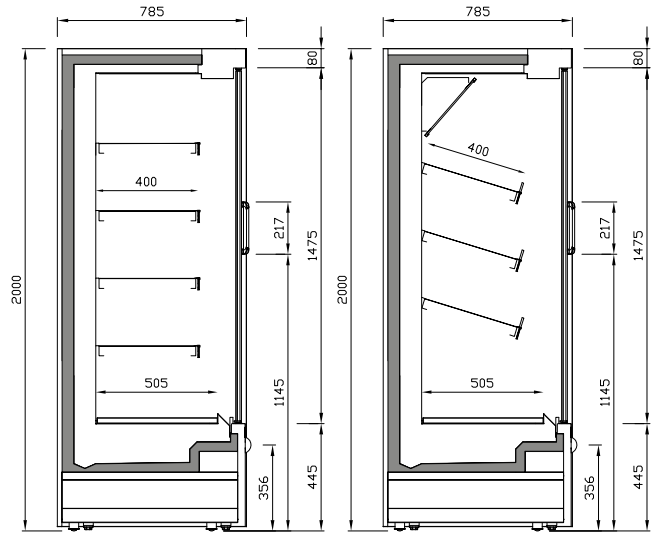

MN DCP M1/M2

MN DCP H1



Mural plug in de refrigeración cerrada

Plug in refrigeration doors multidecks

Murale de réfrigération fermée groupe incorporé



MODELO MODELE MODÈLE	ML9 DCP M1 / DCPC M1	ML12 DCP M1 / DCPC M1	ML18 DCP M1 / DCPC M1	ML25 DCP M1 / DCPC M1
Precio Price Prix	M1 / C M1			
MOD.	ML9 DCP M2 / DCPC M2	ML12 DCP M2 / DCPC M2	ML18 DCP M2 / DCPC M2	ML25 DCP M2 / DCPC M2
Precio Price Prix	M2 / C M2			
MOD.	ML9 DCP H1 / DCPC H1	ML12 DCP H1 / DCPC H1	ML18 DCP H1 / DCPC H1	ML25 DCP H1 / DCPC H1
Precio Price Prix	H1 / C H1			
MOD.	ML9 DCPI M1 / DCPI M2	ML12 DCPI M1 / DCPI M2	ML18 DCPI M1 / DCPI M2	-
Precio Price Prix	INOX M1 / M2			
Medidas Measures Mesures (mm)	938 x 885 x 2000 mm.	1250 x 885 x 2000 mm.	1875 x 885 x 2000 mm.	2500 x 885 x 2000 mm.
Tª. Prod. Aplic. Prod. Tª. Applic. Tª. (°C) Temp. Prod. Temp. Appliq.	M1: -1/+5°C 0/+2°C M2: -1/+7°C +2/+4°C H1: +1/+10°C +4/+6°C			
Clase Climática Climatic class Classe climatique (°C)	3 / 25°C			
Tensión/Frecuencia Electrical data Tension électrique	230V/1ph/50Hz			
Controlador Controller Régulateur	Digital			
Material Material Matériel (EXT/INT)	Acero galvanizado plastificado / Plastified galvanised steel / Acier galvanisé plastifié			
Aislamiento Isolation Isolation (mm)	40kg/m³ / Free CFC's / Zero ODP-GWP			
Capacidad Capacity Capacité (L)	M1, M2: 414 H1: 339	M1, M2: 551 H1: 451	M1, M2: 827 H1: 677	M1, M2: 1103 H1: 903
Superficie exposición Surface exhibition Surface d'exposition (x m²)	M1, M2: 2,07 H1: 1,70	M1, M2: 2,80 H1: 2,30	M1, M2: 4,10 H1: 3,40	M1, M2: 5,50 H1: 4,50
Niveles Exposición Exposition Levels Niveaux d'exposition	M1-M2: 4+Expos. H1: 3+Expos.			
Costados [2] Sides [2] Joues [2] (mm)	40 + 40			
Puertas Doors Portes	2	2	3	4
Sistema de frío Cooling System Système de froid	Ventilado / Ventilated / Ventilé			
Desescarche Defrost Dégivrage	Automático / Automatic / Automatique			
Evaporación Evaporation Evaporation	Forzada / Forced / Ventilé			
Potencia Power Puissance (W)	M1: 627 M2: 672 H1: 673	M1: 714 M2: 770 H1: 770	M1: 837 M2: 899 H1: 899	M1: 1192 M2: 1297 H1: 1297
Potencia frig. Cooling capacity Puissance Frig. (W A -10°C)	-			
Consumo Consumption Consommation (kWh/ 24h)	M1: 8.09 M2: 7.54 H1: 6.07	M1: 9.34 M2: 8.38 H1: 7.10	M1: 10.59 M2: 9.53 H1: 8.57	M1: 16.56 M2: 14.91 H1: 13.41
Refrigerante Refrigerant Gaz	R-290			
Colores estándar Standard colors Couleurs standard	Ext. Estándar / Standar / Standard		Laterales / Sides / Joues	
	Blanco/White/ Blanc	Ral 1015 Ral 1018	No incluidos / Not includes / Non inclus	
	Ral 2003	Ral 3003 Ral 3020		
Laterales disponibles Available sides Joues disponibles	Ral 5015	Ral 5017 Ral 5011	Int. Estándar / Standar / Standard	
	Ral 6002	Ral 6018 Ral 6019	Blanco/White/ Blanc	
	Ral 7035	Ral 7037 Ral 7042	Negro/Black/ Noir	
	Ral 7016	Ral 9006 Negro/Black/ Noir	Ral 7016	
Opciones pág. 426-427 Options pages 426-427 Options pages 426-427				
			Lateral Espejo Mirror end panels Joue Miroir	Lateral Display Display end panels Joue Display

Serie / Series / Série **MDCP (ROTTERDAM)**

+Info: www.infrico.com

ML25 DCPC M2



Nuevo
paragolpes
frontal

New
front
bumper

Nouveau
pare-chocs
frontale



ML25 DCP H1

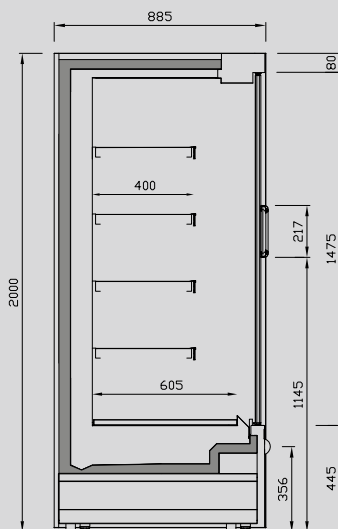

ML DCP M1/M2

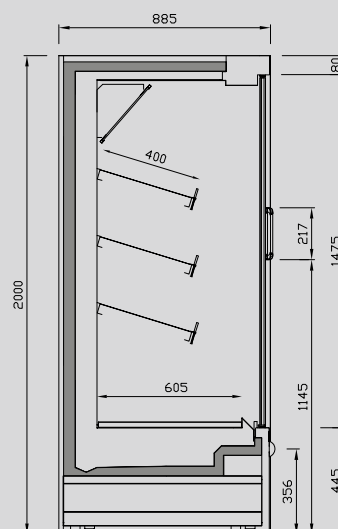

ML DCP H1



Mural plug in de refrigeración abierta frente bajo

Plug in refrigeration open low front multidecks

Murale de réfrigération ouverte groupe incorporé avec frontal bas



MODELO MODELE MODÈLE																																
Precio Price Prix	M1 / C M1																															
MOD.	MS6 P M2 / PC M2	MS9 P M2 / PC M2	MS12 P M2 / PC M2	MS18 P M2 / PC M2	MS25 P M2 / PC M2																											
Precio Price Prix	M2 / C M2																															
MOD.	MS6 P H1 / PC H1	MS9 P H1 / PC H1	MS12 P H1 / PC H1	MS18 P H1 / PC H1	MS25 P H1 / PC H1																											
Precio Price Prix	H1 / C H1																															
MOD.	-	MS9 PI M1 / PI M2	MS12 PI M1 / PI M2	MS18 PI M1 / PI M2	-																											
Precio Price Prix	INOX M1 / M2																															
Medidas Measures Mesures (mm)	625 x 685 x 2000 mm.	938 x 685 x 2000 mm.	1250 x 685 x 2000 mm.	1875 x 685 x 2000 mm.	2500 x 685 x 2000 mm.																											
Tª. Prod. Aplic. Prod. Tª. Applic. Tª. (°C) Temp. Prod. Temp. Appliq.	M1: -1/+5°C 0/+2°C M2: -1/+7°C +2/+4°C H1: +1/+10°C +4/+6°C																															
Clase Climática Climatic class Classe climatique (°C)	3 / 25°C																															
Tensión/Frecuencia Electrical data Tension électrique	230V/1ph/50Hz																															
Controlador Controller Régulateur	Digital																															
Material Material Matériel (EXT/INT)	Acero galvanizado plastificado / Plastified galvanised steel / Acier galvanisé plastifié																															
Aislamiento Isolation Isolation (mm)	40kg/m³ / Free CFC's / Zero ODP-GWP																															
Capacidad Capacity Capacité (L)	M1, M2: 213 H1: 176	M1, M2: 320 H1: 264	M1, M2: 427 H1: 352	M1, M2: 640 H1: 527	M1, M2: 853 H1: 703																											
Área refrigerada Refrigerated area Zone réfrigérée (x m²)	M1, M2: 1,00 H1: 0,82	M1, M2: 1,51 H1: 1,22	M1, M2: 2,01 H1: 1,63	M1, M2: 3,01 H1: 2,45	M1, M2: 4,01 H1: 3,26																											
Niveles Exposición Exposition Levels Niveaux d'exposition	M1-M2: 4+Expos. H1: 3+Expos.																															
Costados [2] Sides [2] Joues [2] (mm)	40 + 40																															
Puertas Doors Portes	-	-	-	-	-																											
Sistema de frío Cooling System Système de froid	Ventilado / Ventilated / Ventilé																															
Desescarche Defrost Dégivrage	Automático / Automatic / Automatique																															
Evaporación Evaporation Evaporation	Forzada / Forced / Ventilé																															
Potencia Power Puissance (W)	M1: 587 M2: - H1: 587	M1: 858 M2: 858 H1: 858	M1: 1250 M2: 1250 H1: 1250	M1: 2413 M2: 2413 H1: 2413	M1: 2374 M2: 2374 H1: 2374																											
Potencia frig. Cooling capacity Puissance Frig. (W A -10°C)	-																															
Consumo Consumption Consommation (kWh/24h)	M1: 7,05 M2: 6,7 H1: 6,7	M1: 10,3 M2: 9,8 H1: 9,3	M1: 14,9 M2: 14,4 H1: 13,5	M1: 26,1 M2: 25,7 H1: 24,3	M1: 29,9 M2: 28,7 H1: 26,9																											
Refrigerante Refrigerant Gaz	R-290																															
Colores estándar Standar colors Couleurs standard	Ext. Estándar / Standar / Standard		Laterales / Sides / Joues																													
Laterales disponibles Available sides Joues disponibles	<table border="1"> <tr> <td>Blanco/White/ Blanc</td> <td>Ral 1015</td> <td>Ral 1018</td> </tr> <tr> <td>Ral 2003</td> <td>Ral 3003</td> <td>Ral 3020</td> </tr> <tr> <td>Ral 5015</td> <td>Ral 5017</td> <td>Ral 5011</td> </tr> <tr> <td>Ral 6002</td> <td>Ral 6018</td> <td>Ral 6019</td> </tr> <tr> <td>Ral 7035</td> <td>Ral 7037</td> <td>Ral 7042</td> </tr> <tr> <td>Ral 7016</td> <td>Ral 9006</td> <td>Negro/Black/ Noir</td> </tr> </table>		Blanco/White/ Blanc	Ral 1015	Ral 1018	Ral 2003	Ral 3003	Ral 3020	Ral 5015	Ral 5017	Ral 5011	Ral 6002	Ral 6018	Ral 6019	Ral 7035	Ral 7037	Ral 7042	Ral 7016	Ral 9006	Negro/Black/ Noir	<table border="1"> <tr> <td colspan="3">No Incluidos / Not includes / Non inclus</td> </tr> <tr> <td colspan="3">Int. Estándar / Standar / Standard</td> </tr> <tr> <td>Blanco/White/ Blanc</td> <td>Negro/Black/ Noir</td> <td>Ral 7016</td> </tr> </table>			No Incluidos / Not includes / Non inclus			Int. Estándar / Standar / Standard			Blanco/White/ Blanc	Negro/Black/ Noir	Ral 7016
Blanco/White/ Blanc	Ral 1015	Ral 1018																														
Ral 2003	Ral 3003	Ral 3020																														
Ral 5015	Ral 5017	Ral 5011																														
Ral 6002	Ral 6018	Ral 6019																														
Ral 7035	Ral 7037	Ral 7042																														
Ral 7016	Ral 9006	Negro/Black/ Noir																														
No Incluidos / Not includes / Non inclus																																
Int. Estándar / Standar / Standard																																
Blanco/White/ Blanc	Negro/Black/ Noir	Ral 7016																														
Opciones pág. 426-427 Options pages 426-427 Options pages 426-427																																
	Lateral Espejo Mirror end panels Joue Miroir		Lateral Display Display end panels Joue Display																													

NEW

Series / Série **MP (MUNICH)**

+Info: www.infrico.com

MS18 P H1



MS18 P M2

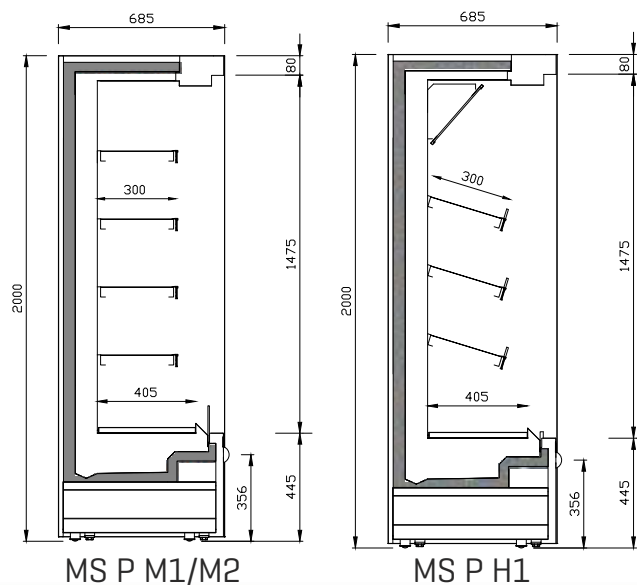







Mural plug in de refrigeración abierta frente bajo

Plug in refrigeration open low front multidecks

Murale de réfrigération ouverte groupe incorporé avec frontal bas

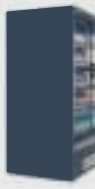

MODELO MODELE MODÈLE					
Precio Price Prix	M1 / C M1				
MOD.	MN6 P M2 / PC M2	MN9 P M2 / PC M2	MN12 P M2 / PC M2	MN18 P M2 / PC M2	MN25 P M2 / PC M2
Precio Price Prix	M2 / C M2				
MOD.	MN6 P H1 / PC H1	MN9 P H1 / PC H1	MN12 P H1 / PC H1	MN18 P H1 / PC H1	MN25 P H1 / PC H1
Precio Price Prix	H1 / C H1				
MOD.	-	MN9 PI M1 / PI M2	MN12 PI M1 / PI M2	MN18 PI M1 / PI M2	-
Precio Price Prix	INOX M1 / M2				
Medidas Measures Mesures (mm)	625 x 785 x 2000 mm.	938 x 785 x 2000 mm.	1250 x 785 x 2000 mm.	1875 x 785 x 2000 mm.	2500 x 785 x 2000 mm.
Tª. Prod. Aplic. Prod. Tª. Applic. Tª. (°C) Temp. Prod. Temp. Appliq.	M1: -1/+5°C 0/+2°C M2: -1/+7°C +2/+4°C H1: +1/+10°C +4/+6°C				
Clase Climática Climatic class Classe climatique (°C)	3 / 25°C				
Tensión/Frecuencia Electrical data Tension électrique	230V/1ph/50Hz				
Controlador Controller Régulateur	Digital				
Material Material Matériel (EXT/INT)	Acero galvanizado plastificado / Plastified galvanised steel / Acier galvanisé plastifié				
Aislamiento Isolation Isolation (mm)	40kg/m³ / Free CFC's / Zero ODP-GWP				
Capacidad Capacity Capacité (L)	M1, M2: 279 H1: 229	M1, M2: 419 H1: 344	M1, M2: 558 H1: 458	M1, M2: 837 H1: 687	M1, M2: 1116 H1: 916
Área refrigerada Refrigerated area Zone réfrigérée (x m²)	M1, M2: 1,32 H1: 1,07	M1, M2: 1,97 H1: 1,60	M1, M2: 2,63 H1: 2,13	M1, M2: 3,95 H1: 3,20	M1, M2: 4,26 H1: 3,04
Niveles Exposición Exposition Levels Niveaux d'exposition	M1-M2: 4+Expos. H1: 3+Expos.				
Costados [2] Sides [2] Joues [2] (mm)	40 + 40				
Puertas Doors Portes	-	-	-	-	-
Sistema de frío Cooling System Système de froid	Ventilado / Ventilated / Ventilé				
Desescarche Defrost Dégivrage	Automático / Automatic / Automatique				
Evaporación Evaporation Evaporation	Forzada / Forced / Ventilé				
Potencia Power Puissance (W)	M1: - M2: - H1: -	M1: 833 M2: 833 H1: 833	M1: 1225 M2: 1225 H1: 1225	M1: 2413 M2: 2413 H1: 2143	M1: 2449 M2: 2449 H1: 2449
Potencia frig. Cooling capacity Puissance Frig. (W A -10°C)	-	-	-	-	-
Consumo Consumption Consommation (kWh/24h)	M1: - M2: - H1: -	M1: 12.7 M2: 11.3 H1: 9.3	M1: 17.1 M2: 17.8 H1: 13.3	M1: 26.7 M2: 24.2 H1: 21.6	M1: 29.1 M2: 28.7 H1: 23.9
Refrigerante Refrigerant Gaz	R-290				
Colores estándar Standar colors Couleurs standard	Ext. Estándar / Standar / Standard		Laterales / Sides / Joues		
	Blanco/White/ Blanc	Ral 1015 Ral 1018	No Incluidos / Not includes / Non inclus		
	Ral 2003	Ral 3003 Ral 3020			
Laterales disponibles Available sides Joues disponibles	Ral 5015	Ral 5017 Ral 5011	Int. Estándar / Standar / Standard		
	Ral 6002	Ral 6018 Ral 6019	Blanco/White/ Blanc	Negro/Black/ Noir	Ral 7016
	Ral 7035	Ral 7037 Ral 7042			
Opciones pág. 426-427 Options pages 426-427 Options pages 426-427	Ral 7016	Ral 9006 Negro/Black/ Noir			
					

NEW

Series / Série **MP (MUNICH)**

+Info: www.infrico.com

MN18 P M2



**Nuevo
paragolpes
frontal**

**New
front
bumper**

**Nouveau
pare-chocs
frontale**



MN18 P H1

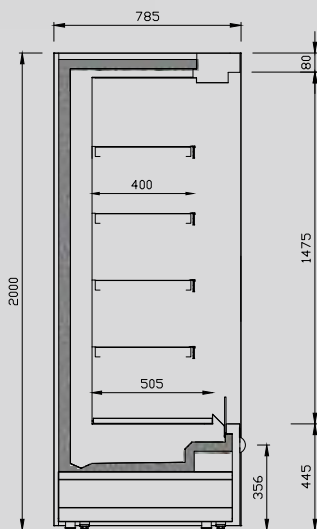

MN P M1/M2

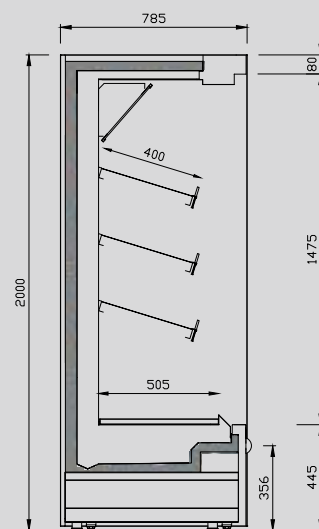

MN P H1



Mural plug in de refrigeración abierta frente bajo

Plug in refrigeration open low front multidecks

Murale de réfrigération ouverte groupe incorporé avec frontal bas



MODELO MODELE MODÈLE	ML6 P M1 / PC M1	ML9 P M1 / PC M1	ML12 P M1 / PC M1	ML18 P M1 / PC M1	ML25 P M1 / PC M1
Precio Price Prix	M1 / C M1				
MOD.	ML6 P M2 / PC M2	ML9 P M2 / PC M2	ML12 P M2 / PC M2	ML18 P M2 / PC M2	ML25 P M2 / PC M2
Precio Price Prix	M2 / C M2				
MOD.	ML6 P H1 / PC H1	ML9 P H1 / PC H1	ML12 P H1 / PC H1	ML18 P H1 / PC H1	ML25 P H1 / PC H1
Precio Price Prix	H1 / C H1				
MOD.	-	ML9 PI M1 / PI M2	ML12 PI M1 / PI M2	ML18 PI M1 / PI M2	-
Precio Price Prix	INOX M1 / M2				
Medidas Measures Mesures (mm)	625 x 885 x 2000 mm.	938 x 885 x 2000 mm.	1250 x 885 x 2000 mm.	1875 x 885 x 2000 mm.	2500 x 885 x 2000 mm.
Tª. Prod. Aplic. Prod. Tª. Applic. Tª. (°C) Temp. Prod. Temp. Appliq.	M1: -1/+5°C 0/+2°C M2: -1/+7°C +2/+4°C H1: +1/+10°C +4/+6°C				
Clase Climática Climatic class Classe climatique (°C)	3 / 25°C				
Tensión/Frecuencia Electrical data Tension électrique	230V/1ph/50Hz				
Controlador Controller Régulateur	Digital				
Material Material Matériel [EXT/INT]	Acero galvanizado plastificado / Plastified galvanised steel / Acier galvanisé plastifié				
Aislamiento Isolation Isolation (mm)	40kg/m³ / Free CFC's / Zero ODP-GWP				
Capacidad Capacity Capacité (L)	M1, M2: 295 H1: 245	M1, M2: 442 H1: 367	M1, M2: 589 H1: 489	M1, M2: 884 H1: 734	M1, M2: 1178 H1: 978
Área refrigerada Refrigerated area Zone réfrigérée (x m²)	M1, M2: 1,38 H1: 1,13	M1, M2: 2,07 H1: 1,69	M1, M2: 2,76 H1: 2,26	M1, M2: 4,13 H1: 3,38	M1, M2: 5,51 H1: 4,51
Niveles Exposición Exposition Levels Niveaux d'exposition	M1-M2: 4+Expos. H1: 3+Expos.				
Costados [2] Sides [2] Joues [2] (mm)	40 + 40				
Puertas Doors Portes	-	-	-	-	-
Sistema de frío Cooling System Système de froid	Ventilado / Ventilated / Ventilé				
Desescarche Defrost Dégivrage	Automático / Automatic / Automatique				
Evaporación Evaporation Evaporation	Forzada / Forced / Ventilé				
Potencia Power Puissance (W)	M1: - M2: - H1: -	M1: 833 M2: 833 H1: 833	M1: 1225 M2: 1225 H1: 1225	M1: 2338 M2: 2338 H1: 2338	M1: 2374 M2: 2374 H1: 2374
Potencia frig. Cooling capacity Puissance Frig. (W A -10°C)	-				
Consumo Consumption Consommation (kWh/24h)	M1: - M2: - H1: -	M1: 12.1 M2: 11.4 H1: 9.44	M1: 17.5 M2: 18.1 H1: 13.6	M1: 27.3 M2: 24.7 H1: 22.1	M1: 29.6 M2: 27.7 H1: 24.4
Refrigerante Refrigerant Gaz	R-290				
Colores estándar Standar colors Couleurs standard	Ext. Estándar / Standar / Standard		Laterales / Sides / Joues		
	Blanco/White/ Blanc	Ral 1015 Ral 1018	No Incluidos / Not includes / Non inclus		
	Ral 2003	Ral 3003 Ral 3020			
Laterales disponibles Available sides Joues disponibles	Ral 5015	Ral 5017 Ral 5011	Int. Estándar / Standar / Standard		
	Ral 6002	Ral 6018 Ral 6019	Blanco/White/ Blanc	Negro/Black/ Noir	Ral 7016
	Ral 7035	Ral 7037 Ral 7042			
Opciones pág. 426-427 Options pages 426-427 Options pages 426-427	Ral 7016	Ral 9006 Negro/Black/ Noir			
			Lateral Espejo Mirror end panels Joue Miroir		Lateral Display Display end panels Joue Display

NEW

Series / Série **MP (MUNICH)**

+Info: www.infrico.com

ML18 P H1



**Nuevo
paragolpes
frontal**

**New
front
bumper**

**Nouveau
pare-chocs
frontale**



ML18 P M2

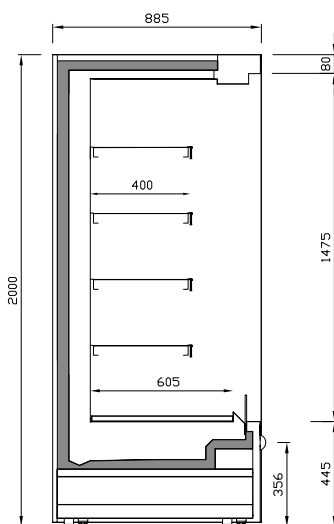

ML P M1/M2

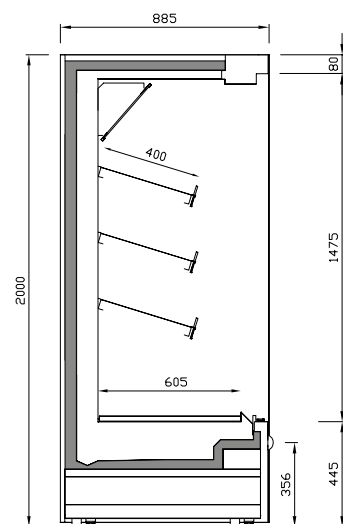

ML P H1











Murales Experience para Quesos y Bacalao

Plug in R-290 Experience multidecks for cheese and codfish

Murale Experience de réfrigération groupe incorporé R-290 pour le fromage et la morue



MODELO MODELE MODÈLE	QUESOS / CHEESE / FROMAGE 	MS 12 BA M1 	BACALAO / CODFISH / MORUE 	MS 12 DC BA M1 
Precio Price Prix				
Medidas Measures [mm] Mesures	938 x 685 x 2000 mm.	1250 x 685 x 2000 mm.	938 x 685 x 2000 mm.	1250 x 685 x 2000 mm.
T°. Prod. Aplic. Prod. T°. Applic. T°. [°C] Temp. Prod. Temp. Appliq.	M1: -1/+5°C 0/+2°C			
Clase Climática Climatic class Classe climatique [°C]	3 / 25°C			
Tensión/Frecuencia Electrical data Tension électrique	230V/1ph/50Hz			
Controlador Controller Régulateur	Digital			
Material Matériel [EXT/INT]	EXT: Acero inox AISI304 / Stainless Steel AISI304 / Acier inox AISI304 INT: Acero inox AISI304 (ventiladores, cubre evaporador, cuba) / Stainless Steel AISI304 (fans, cooler cover, tank) / Acier inox AISI304 (ventilateurs, couvercle évaporateur, bac) INT en contacto con producto / in contact with product / en contact avec le produit : Acero inox AISI316 / Stainless Steel AISI316 / Acier inox AISI316			
Aislamiento Isolation [mm]	40kg/m ³ / Free CFC's / Zero ODP-GWP			
Capacidad Capacity [L] Capacité	321	428	321	428
Superficie exposición Surface exhibition [x m ²] Surface d'exposition	1,51	2,01	1,51	2,01
Compresor Compressor [HP] Compresseur	3/4	3/4	1	1+1/4
Niveles Exposición Exposition Levels Niveaux d'exposition	-			
Costados [2] Sides [2] [mm] Joues [2]	40+40			
Sistema de frío Cooling System Système de froid	Ventilado / Ventilated / Ventilé			
Desescarche Defrost Dégivrage	Automático / Automatic / Automatique			
Evaporación Evaporation Évaporation	Forzada / Forced / Ventilé			
Potencia Power [W] Puissance	858	1250	602	715
Potencia frig. Cooling capacity [W A -10°C] Puissance Frig.	-			
Consumo Consumption [kWh/ 24h] Consommation	10,3	14,9	8,9	9,9
Refrigerante Refrigerant Gaz	R-290			
Colores estándar Standar colors Couleurs standard	Color exterior / Exterior color / Couleur extérieure 		 Lateral Espejo Mirror end panels Joue Miroir  Lateral Display Display end panels Joue Display	
Laterales disponibles Available sides Joues disponibles	Color interior / Interior color / Couleur intérieure 			
Opciones pág. 426-427 Options pages 426-427 Options pages 426-427				

NEW

Series / Série **MSBA (OPORTO)**
 / Series / Série **MSDCBA (ORLEANS)**

+Info: www.infrico.com

MS 12 DC BA



MS 9 BA

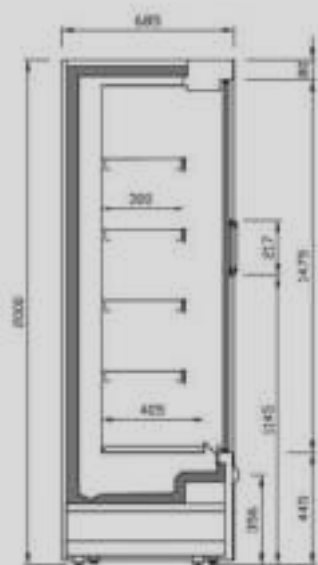

MS DC BA



**Nuevo
paragolpes
frontal**

**New
front
bumper**

**Nouveau
pare-chocs
frontale**

**Evaporador anticorrosión con
tratamiento de cataforesis**

**Anti-corrosion evaporator with
cataphoresis treatment**

**Evaporateur anti-corrosion avec
traitement par cataphorèse**



**Cataforesis
Cataphoresis
Cataphorèse**





MS BA

Mural remota de refrigeración cerrada frente medio

Remote refrigeration doors middle front multideck

Murale de réfrigération fermée groupe à distance front moyenne



MODELO MODELE MODÈLE	MN12 DR M1	MN18 DR M1	MN25 DRM1	MN37 DR M1
Precio Price Prix	M1			
MOD.	MN12 DR M2	MN18 DR M2	MN25 DR M2	MN37 DR M2
Precio Price Prix	M2			
MOD.	MN12 DR H1	MN18 DR H1	MN25 DR H1	MN37 DR H1
Precio Price Prix	H1			
Medidas / Measures / Mesures / [mm]	1250 x 785 x 2050 mm.	1875 x 785 x 2050 mm.	2500 x 785 x 2050 mm.	3750 x 785 x 2050 mm.
Sin costados / Without sides / Sans joues				
T°. Prod. Aplic. Prod. T°. Applic. T°. [°C] Temp. Prod. Temp. Appliq.	M1: -1/+5°C 0/+2°C M2: -1/+7°C +2/+4°C H1: +1/+10°C +4/+6°C			
Clase Climática Climatic class [°C] Classe climatique	3 / 25°C			
Tensión/Frecuencia Electrical data Tension électrique	230V/1ph/50Hz			
Controlador Controller Régulateur	Digital			
Material Material Matériel [EXT/INT]	Acero galvanizado plastificado / Plastified galvanised steel / Acier galvanisé plastifié			
Aislamiento Isolation Isolation [mm]	40kg/m ³ / Free CFC's / Zero ODP-GWP			
Capacidad Capacity Capacité [L]	M1, M2: 505 H1: 423	M1, M2: 758 H1: 634	M1, M2: 1010 H1: 845	M1, M2: 1515 H1: 1268
Superficie exposición Surface exhibition [x m ²] Surface d'exposition	1,65	2,47	3,30	5,04
Niveles Exposición Exposition Levels Niveaux d'exposition	M1, M2: 4+Expos. H1: 3+Expos.			
Costados [2] Sides [2] Joues [2] [mm]	40 + 40			
Puertas Doors Portes	2	3	4	6
Sistema de frío Cooling System Système de froid	Ventilado / Ventilated / Ventilé			
Desescarche Defrost Dégivrage	Automático / Automatic / Automatique			
Evaporación Evaporation Évaporation	Forzada / Forced / Ventilé			
Potencia Power Puissance [W]	-			
Potencia frig. Cooling capacity Puissance Frig. [W A -10°C]	M1: 850 M2: 734 H1: 606	M1: 1275 M2: 1101 H1: 908	M1: 1701 M2: 1468 H1: 1211	M1: 2551 M2: 2202 H1: 1817
Consumo Consumption Consommation [kWh/ 24h]	-			
Refrigerante Refrigerant Gaz	FREON			
Colores estándar Standard colors Couleurs standard	Int. Estándar / Standar / Standard			Laterales / Sides / Joues No Incluidos / Not includes / Non inclus
	Blanco/White/ Blanc	Negro/Black/ Noir	Ral 7016	
Laterales disponibles Available sides Joues disponibles	Ext. Estándar / Standar / Standard			 Lateral Espejo Mirror end panels Joue Miroir  Lat. Panorámico Panoramic end panels Joue panoramique  Lateral Display Display end panels Joue Display
	Blanco/White/ Blanc	Ral 1015	Ral 1018	
Ral 2003	Ral 3003	Ral 3020		
Ral 5015	Ral 5017	Ral 5011		
Ral 6002	Ral 6018	Ral 6019		
Ral 7035	Ral 7037	Ral 7042		
Ral 7016	Ral 9006	Negro/Black/ Noir		
Opciones pág. 426-427 Options pages 426-427 Options pages 426-427				

Series / Série **MDR (RIMINI)**

+Info: www.infrico.com

NEW

MN25DR M1



Nuevo paragolpes frontal

New front bumper

Nouveau pare-chocs frontale

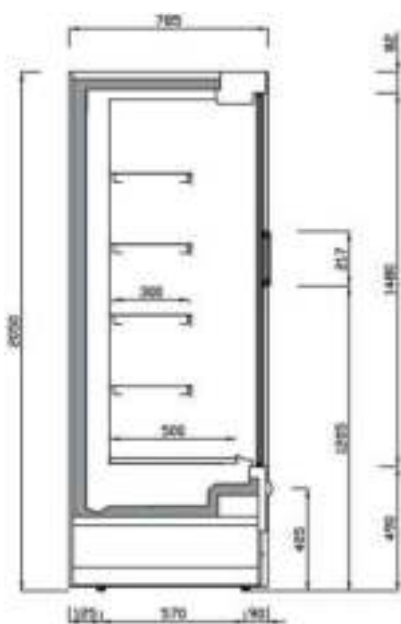

MN DR M1/M2



Frente medio
Middle front
Front moyenne

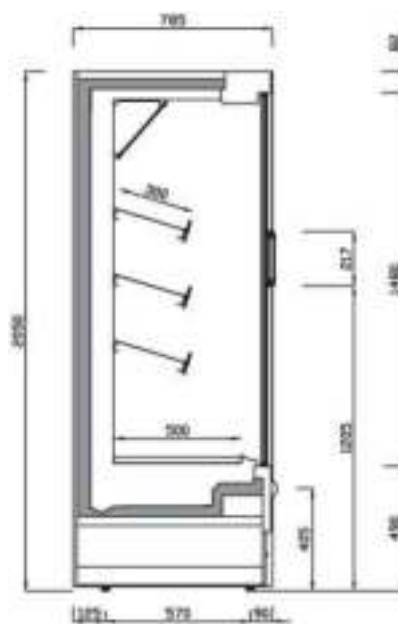



MN DR H1

Mural remota de refrigeración cerrada frente medio

Remote refrigeration doors middle front multideck

Murale de réfrigération fermée groupe à distance front moyenne



MODELO MODELE MODÈLE	ML12 DR M1	ML18 DR M1	ML25 DRM1	ML31 DRM1	ML37 DR M1	
Precio Price Prix	M1					
MOD.	ML12 DR M2	ML18 DR M2	ML25 DR M2	ML31 DR M2	ML37 DR M2	
Precio Price Prix	M2					
MOD.	ML12 DR H1	ML18 DR H1	ML25 DR H1	ML31 DR H1	ML37 DR H1	
Precio Price Prix	H1					
Medidas / Mesures / Mesures / [mm] Sin costados / Without sides / Sans joues	1250 x 885 x 2050 mm.	1875 x 885 x 2050 mm.	2500 x 885 x 2050 mm.	3125 x 885 x 2050 mm.	3750 x 885 x 2050 mm.	
T°. Prod. Aplic. Prod. T°. Applic. T°. [°C] Temp. Prod. Temp. Appliq.	M1: -1/+5°C 0/+2°C M2: -1/+7°C +2/+4°C H1: +1/+10°C +4/+6°C					
Clase Climática Climatic class [°C] Classe climatique	3 / 25°C					
Tensión/Frecuencia Electrical data Tension électrique	230V/1ph/50Hz					
Controlador Controller Régulateur	Digital					
Material Material Matériel [EXT/INT]	Acero galvanizado plastificado / Plastified galvanised steel / Acier galvanisé plastifié					
Aislamiento Isolation Isolation [mm]	40kg/m ³ / Free CFC's / Zero ODP-GWP					
Capacidad Capacity Capacité [L]	M1, M2: 588 H1: 488	M1, M2: 881 H1: 731	M1, M2: 1175 H1: 975	M1, M2: 1469 H1: 1219	M1, M2: 1763 H1: 1460	
Superficie exposición Surface exhibition [x m ²] Surface d'exposition	M1, M2: 2,75 H1: 2,25	M1, M2: 4,13 H1: 3,40	M1, M2: 5,50 H1: 4,80	M1, M2: 6,80 H1: 5,60	M1, M2: 8,30 H1: 6,70	
Niveles Exposición Exposition Levels Niveaux d'exposition	M1, M2: 4+Expos. H1: 3+Expos.					
Costados [2] Sides [2] Joues [2] [mm]	40 + 40					
Puertas Doors Portes	2	3	4	5	6	
Sistema de frío Cooling System Système de froid	Ventilado / Ventilated / Ventilé					
Desescarche Defrost Dégivrage	Automático / Automatic / Automatique					
Evaporación Evaporation Évaporation	Forzada / Forced / Ventilé					
Potencia Power Puissance [W]	-					
Potencia frig. Cooling capacity Puissance Frig. [W A -10°C]	M1: 895 M2: 773 H1: 638	M1: 1343 M2: 1159 H1: 956	M1: 1790 M2: 1545 H1: 1275	M1: 2238 M2: 1931 H1: 1594	M1: 2685 M2: 2318 H1: 1913	
Consumo Consumption Consommation [kWh/ 24h]	-					
Refrigerante Refrigerant Gaz	FREON					
Colores estándar Standard colors Couleurs standard	Int. Estándar / Standar / Standard		Laterales / Sides / Joues			
	Blanco/White/ Blanc	Negro/Black/ Noir	Ral 7016	No Incluidos / Not includes / Non inclus		
Laterales disponibles Available sides Joues disponibles	Ext. Estándar / Standar / Standard					
	Blanco/White/ Blanc	Ral 1015	Ral 1018			
Opciones pág. 426-427 Options pages 426-427 Options pages 426-427	Ral 2003	Ral 3003	Ral 3020			
	Ral 5015	Ral 5017	Ral 5011			
	Ral 6002	Ral 6018	Ral 6019			
	Ral 7035	Ral 7037	Ral 7042			
	Ral 7016	Ral 9006	Negro/Black/ Noir			
				  		

NEW

ML37 DR M1



Nuevo paragolpes frontal

New front bumper

Nouveau pare-chocs frontale

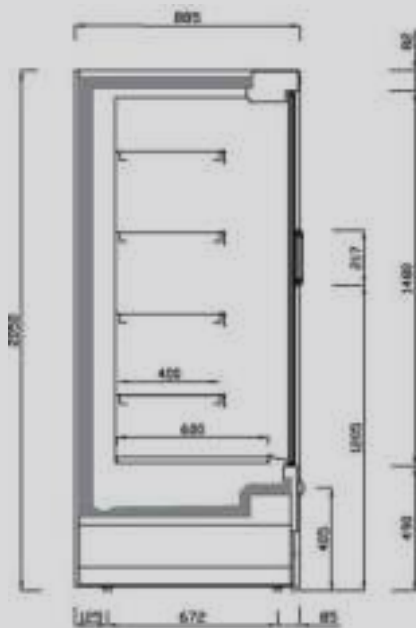

ML DR M1/M2

Frente medio
Middle front
Front moyenne

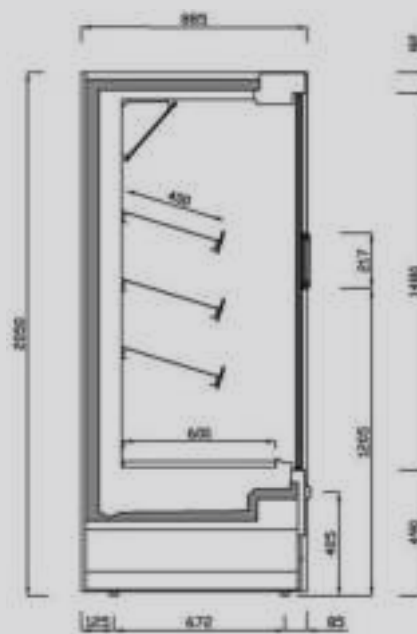







ML DR H1

Mural remota de refrigeración cerradas

Remote refrigeration doors multideck

Murales de réfrigération fermée groupe à distance

MODELO MODELE MODÈLE				
Precio Price Prix	M1			
MOD.	MS12 DG M2	MS18 DG M2	MS25 DG M2	MS37 DG M2
Precio Price Prix	M2			
MOD.	MS12 DG H1	MS18 DG H1	MS25 DG H1	MS37 DG H1
Precio Price Prix	H1			
Medidas / Measures / Mesures / (mm)	1250 x 680 x 2050 mm.	1875 x 680 x 2050 mm.	2500 x 680 x 2050 mm.	3750 x 680 x 2050 mm.
Sin costados / Without sides / Sans joues				
T°. Prod. Aplic. Prod. T°. Applic. T°. (°C) Temp. Prod. Temp. Appliq.	M1: -1/+5°C 0/+2°C M2: -1/+7°C +2/+4°C H1: +1/+10°C +4/+6°C			
Clase Climática Climatic class Classe climatique (°C)	3 / 25°C			
Tensión/Frecuencia Electrical data Tension électrique	230V/1ph/50Hz			
Controlador Controller Régulateur	Digital			
Material Material Matériel (EXT/INT)	Acero galvanizado plastificado / Plastified galvanised steel / Acier galvanisé plastifié			
Aislamiento Isolation Isolation (mm)	40kg/m ³ / Free CFC's / Zero ODP-GWP			
Capacidad Capacity Capacité (L)	M1, M2: 401 H1: 326	M1, M2: 602 H1: 489	M1, M2: 803 H1: 653	M1, M2: 1204 H1: 979
Superficie exposición Surface exhibition Surface d'exposition (x m ²)	M1, M2: 2,01 H1: 1,63	M1, M2: 3,01 H1: 2,45	M1, M2: 4,01 H1: 3,26	M1, M2: 6,02 H1: 4,89
Niveles Exposición Exposition Levels Niveaux d'exposition	M1, M2: 4+Expos. H1: 3+Expos.			
Costados (2) Sides (2) Joues (2) (mm)	40 + 40			
Puertas Doors Portes	2	3	4	6
Sistema de frío Cooling System Système de froid	Ventilado / Ventilated / Ventilé			
Desescarche Defrost Dégivrage	Automático / Automatic / Automatique			
Evaporación Evaporation Évaporation	Forzada / Forced / Ventilé			
Potencia Power Puissance (W)	-			
Potencia frig. Cooling capacity Puissance Frig. (W A -10°C)	M1: 895 M2: 773 H1: 638	M1: 1343 M2: 1159 H1: 956	M1: 1790 M2: 1545 H1: 1275	M1: 2685 M2: 2318 H1: 1913
Consumo Consumption Consommation (kWh/ 24h)	-			
Refrigerante Refrigerant Gaz	FREON			
Colores estándar Standar colors Couleurs standard	Int. Estándar / Standar / Standard			Laterales / Sides / Joues No Incluidos / Not includes / Non inclus
	Blanco/White/ Blanc	Negro/Black/ Noir	Ral 7016	
Laterales disponibles Available sides Joues disponibles	Ext. Estándar / Standar / Standard			 Lateral Espejo Mirror end panels Joue Miroir  Lat. Panorámico Panoramic end panels Joue panoramique  Lateral Display Display end panels Joue Display
	Blanco/White/ Blanc	Ral 1015	Ral 1018	
Ral 2003	Ral 3003	Ral 3020		
Ral 5015	Ral 5017	Ral 5011		
Ral 6002	Ral 6018	Ral 6019		
Ral 7035	Ral 7037	Ral 7042		
Ral 7016	Ral 9006	Negro/Black/ Noir		
Opciones pág. 426-427 Options pages 426-427 Options pages 426-427				

NEW

Series / Série **MDG (PORTLAND)**

+Info: www.infrico.com

MS37DG M2



MS25DG H1

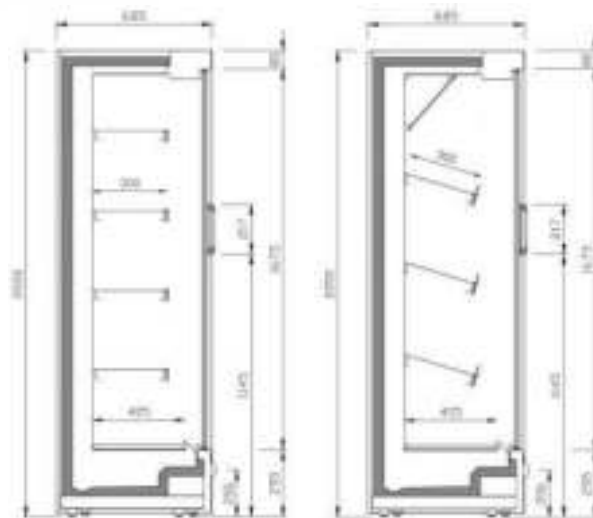

MS DG M1/M2

MS DG H1



Mural remota de refrigeración cerradas

Remote refrigeration doors multideck

Murales de réfrigération fermée groupe à distance

MODELO Price Price Prix	MN12 DG MO		MN18 DG MO		MN25 DG MO		MN37 DG MO																						
MO																													
MOD.	MN12 DG M1		MN18 DG M1		MN25 DG M1		MN37 DG M1																						
M1																													
MOD.	MN12 DG M2		MN18 DG M2		MN25 DG M2		MN37 DG M2																						
M2																													
MOD.	MN12 DG H1		MN18 DG H1		MN25 DG H1		MN37 DG H1																						
H1																													
Medidas / Measures / Mesures / [mm] Sin costados / Without sides / Sans joues	1250 x 785 x 2050 mm.		1875 x 785 x 2050 mm.		2500 x 785 x 2050 mm.		3750 x 785 x 2050 mm.																						
T°. Prod. Aplic. Prod. T°. Applic. T°. (°C) Temp. Prod. Temp. Appliq. (°C)	M0: -1/+4°C -1/+1°C		M1: -1/+5°C 0/+2°C		M2: -1/+7°C +2/+4°C		H1: +1/+10°C +4/+6°C																						
Clase Climática Climatic class Classe climatique (°C)	3 / 25°C																												
Tensión/Frecuencia Electrical data Tension électrique	230V/1ph/50Hz																												
Controlador Controller Régulateur	Digital																												
Material Material Matériel (EXT/INT)	Acero galvanizado plastificado / Plastified galvanised steel / Acier galvanisé plastifié																												
Aislamiento Isolation Isolation (mm)	40kg/m ³ / Free CFC's / Zero ODP-GWP																												
Capacidad Capacity Capacité (L)	M0, M1, M2: 766 H1: 655		M0, M1, M2: 1149 H1: 983		M0, M1, M2: 1533 H1: 1310		M0, M1, M2: 2299 H1: 1965																						
Superficie exposición Surface exhibition Surface d'exposition (x m²)	M0, M1, M2: 2,64 H1: 2,14		M0, M1, M2: 3,96 H1: 3,21		M0, M1, M2: 5,28 H1: 4,30		M0, M1, M2: 7,91 H1: 6,40																						
Niveles Exposición Exposition Levels Niveaux d'exposition	M0, M1, M2: 4+Expos. H1: 3+Expos.																												
Costados (2) Sides (2) Joues (2) (mm)	40 + 40																												
Puertas Doors Portes	2		3		4		6																						
Sistema de frío Cooling System Système de froid	Ventilado / Ventilated / Ventilé																												
Desescarche Defrost Dégivrage	Automático / Automatic / Automatique																												
Evaporación Evaporation Évaporation	Forzada / Forced / Ventilé																												
Potencia Power Puissance (W)	-																												
Potencia frig. Cooling capacity Puissance Frig. (W A -10°C)	M0: 986 M1: 895 M2: 773 H1: 638		M0: 1479 M1: 1343 M2: 1159 H1: 956		M0: 1973 M1: 1790 M2: 1545 H1: 1275		M0: 2959 M1: 2685 M2: 2318 H1: 1913																						
Consumo Consumption Consommation (kWh/24h)	-																												
Refrigerante Refrigerant Gaz	FREON																												
Colores estándar Standard colors Couleurs standard	Ext. Estándar / Standar / Standard			Int. Estándar / Standar / Standard																									
Laterales disponibles Available sides Joues disponibles	<table border="1"> <tr> <td>Blanco/White/Blanc</td> <td>Ral 1015</td> <td>Ral 1018</td> </tr> <tr> <td>Ral 2003</td> <td>Ral 3003</td> <td>Ral 3020</td> </tr> <tr> <td>Ral 5015</td> <td>Ral 5017</td> <td>Ral 5011</td> </tr> <tr> <td>Ral 6002</td> <td>Ral 6018</td> <td>Ral 6019</td> </tr> <tr> <td>Ral 7035</td> <td>Ral 7037</td> <td>Ral 7042</td> </tr> <tr> <td>Ral 7016</td> <td>Ral 9006</td> <td>Negro/Black/Noir</td> </tr> </table>			Blanco/White/Blanc	Ral 1015	Ral 1018	Ral 2003	Ral 3003	Ral 3020	Ral 5015	Ral 5017	Ral 5011	Ral 6002	Ral 6018	Ral 6019	Ral 7035	Ral 7037	Ral 7042	Ral 7016	Ral 9006	Negro/Black/Noir	<table border="1"> <tr> <td>Blanco/White/Blanc</td> <td>Negro/Black/Noir</td> <td>Ral 7016</td> </tr> </table>					Blanco/White/Blanc	Negro/Black/Noir	Ral 7016
Blanco/White/Blanc	Ral 1015	Ral 1018																											
Ral 2003	Ral 3003	Ral 3020																											
Ral 5015	Ral 5017	Ral 5011																											
Ral 6002	Ral 6018	Ral 6019																											
Ral 7035	Ral 7037	Ral 7042																											
Ral 7016	Ral 9006	Negro/Black/Noir																											
Blanco/White/Blanc	Negro/Black/Noir	Ral 7016																											
Opciones pág. 426-427 Options pages 426-427 Options pages 426-427	<table border="1"> <tr> <td colspan="3">No Incluidos / Not includes / Non includes</td> </tr> </table>			No Incluidos / Not includes / Non includes			<table border="1"> <tr> <td></td> <td></td> <td></td> </tr> </table>																						
No Incluidos / Not includes / Non includes																													

Serie / Series / Série **MDG (PORTLAND)**

+Info: www.infrico.com

MN25DG M2



MN25DG H1

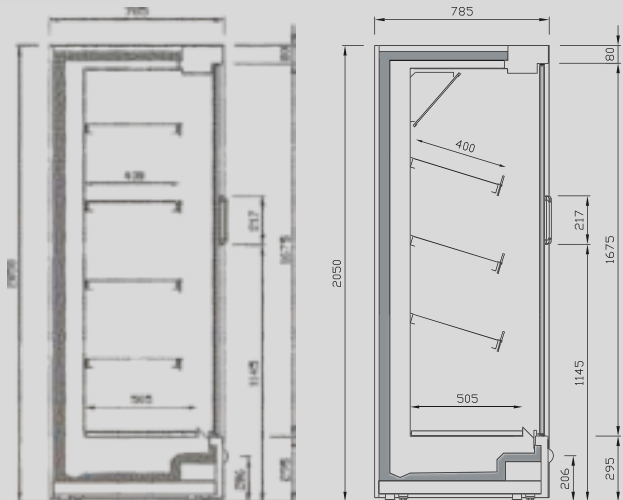

MN DG M0/M1/M2

MN DG H1



Mural remota de refrigeración cerradas

Remote refrigeration doors multideck

Murales de réfrigération fermée groupe à distance

N: 785

MODELO Price Price Prix	MN12 DG22 M0		MN18 DG22 M0		MN25 DG22 M0		MN37 DG22 M0																						
M0																													
MOD.	MN12 DG22 M1		MN18 DG22 M1		MN25 DG22 M1		MN37 DG22 M1																						
M1																													
MOD.	MN12 DG22 M2		MN18 DG22 M2		MN25 DG22 M2		MN37 DG22 M2																						
M2																													
MOD.	MN12 DG22 H1		MN18 DG22 H1		MN25 DG22 H1		MN37 DG22 H1																						
H1																													
Medidas / Measures / Mesures / [mm] Sin costados / Without sides / Sans joues	1250 x 785 x 2200 mm.		1875 x 785 x 2200 mm.		2500 x 785 x 2200 mm.		3750 x 785 x 2200 mm.																						
T°. Prod. Aplic. Prod. T°. Applic. T°. (°C) Temp. Prod. Temp. Appliq.	M0: -1/+4°C -1/+1°C		M1: -1/+5°C 0/+2°C		M2: -1/+7°C +2/+4°C		H1: +1/+10°C +4/+6°C																						
Clase Climática Climatic class Classe climatique (°C)	3 / 25°C																												
Tensión/Frecuencia Electrical data Tension électrique	230V/1ph/50Hz																												
Controlador Controller Régulateur	Digital																												
Material Material Matériel (EXT/INT)	Acero galvanizado plastificado / Plastified galvanised steel / Acier galvanisé plastifié																												
Aislamiento Isolation Isolation [mm]	40kg/m ³ / Free CFC's / Zero ODP-GWP																												
Capacidad Capacity Capacité [L]	M0, M1, M2: 816 H1: 705		M0, M1, M2: 1224 H1: 1058		M0, M1, M2: 1633 H1: 1410		M0, M1, M2: 2449 H1: 2115																						
Superficie exposición Surface exhibition Surface d'exposition [x m²]	M0, M1, M2: 3,14 H1: 2,64		M0, M1, M2: 4,71 H1: 3,96		M0, M1, M2: 6,28 H1: 5,30		M0, M1, M2: 9,41 H1: 7,90																						
Niveles Exposición Exposition Levels Niveaux d'exposition	M0, M1, M2: 5+Expos. H1: 4+Expos.																												
Costados [2] Sides [2] Joues [2] [mm]	40 + 40																												
Puertas Doors Portes	2		3		4		6																						
Sistema de frío Cooling System Système de froid	Ventilado / Ventilated / Ventilé																												
Desescarche Defrost Dégivrage	Automático / Automatic / Automatique																												
Evaporación Evaporation Évaporation	Forzada / Forced / Ventilé																												
Potencia Power Puissance [W]	-																												
Potencia frig. Cooling capacity Puissance Frig. [W A -10°C]	M0: 1018 M2: 815	M1: 928 H1: 683	M0: 1596 M2: 1223	M1: 1391 H1: 1024	M0: 2035 M2: 1630	M1: 1855 H1: 1365	M0: 3053 M2: 2445	M1: 2783 H1: 2048																					
Consumo Consumption Consommation [kWh/24h]	-																												
Refrigerante Refrigerant Gaz	FREON																												
Colores estándar Standard colors Couleurs standard	Ext. Estándar / Standar / Standard			Int. Estándar / Standar / Standard																									
Laterales disponibles Available sides Joues disponibles	<table border="1"> <tr> <td>Blanco/White/Blanc</td> <td>Ral 1015</td> <td>Ral 1018</td> </tr> <tr> <td>Ral 2003</td> <td>Ral 3003</td> <td>Ral 3020</td> </tr> <tr> <td>Ral 5015</td> <td>Ral 5017</td> <td>Ral 5011</td> </tr> <tr> <td>Ral 6002</td> <td>Ral 6018</td> <td>Ral 6019</td> </tr> <tr> <td>Ral 7035</td> <td>Ral 7037</td> <td>Ral 7042</td> </tr> <tr> <td>Ral 7016</td> <td>Ral 9006</td> <td>Negro/Black/Noir</td> </tr> </table>			Blanco/White/Blanc	Ral 1015	Ral 1018	Ral 2003	Ral 3003	Ral 3020	Ral 5015	Ral 5017	Ral 5011	Ral 6002	Ral 6018	Ral 6019	Ral 7035	Ral 7037	Ral 7042	Ral 7016	Ral 9006	Negro/Black/Noir	<table border="1"> <tr> <td>Blanco/White/Blanc</td> <td>Negro/Black/Noir</td> <td>Ral 7016</td> </tr> </table>					Blanco/White/Blanc	Negro/Black/Noir	Ral 7016
Blanco/White/Blanc	Ral 1015	Ral 1018																											
Ral 2003	Ral 3003	Ral 3020																											
Ral 5015	Ral 5017	Ral 5011																											
Ral 6002	Ral 6018	Ral 6019																											
Ral 7035	Ral 7037	Ral 7042																											
Ral 7016	Ral 9006	Negro/Black/Noir																											
Blanco/White/Blanc	Negro/Black/Noir	Ral 7016																											
Opciones pág. 426-427 Options pages 426-427 Options pages 426-427	<table border="1"> <tr> <td colspan="3">No Incluidos / Not includes / Non inclus</td> </tr> </table>			No Incluidos / Not includes / Non inclus																									
No Incluidos / Not includes / Non inclus																													

Serie / Series / Série **MDG (PORTLAND)**

+Info: www.infrico.com

MN37DG22 M2



**Nuevo
paragolpes
frontal**

**New
front
bumper**

**Nouveau
pare-chocs
frontale**



MN25DG22 H1

Lateral panorámico
Panoramic side panel
Joue panoramique

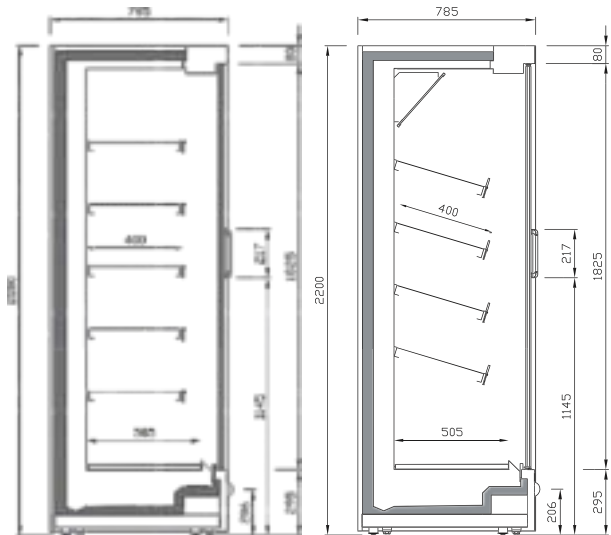

MN DG22 M0/M1/M2

MN DG22 H1









Mural remota de refrigeración cerradas

Remote refrigeration doors multideck

Murales de réfrigération fermée groupe à distance

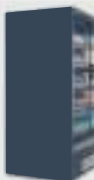

MODELO MODELE MODÈLE										
Precio Price Prix	M0									
MOD.	ML12 DG M1	ML18 DG M1	ML25 DG M1	ML31 DG M1	ML37 DG M1					
Precio Price Prix	M1									
MOD.	ML12 DG M2	ML18 DG M2	ML25 DG M2	ML31 DG M2	ML37 DG M2					
Precio Price Prix	M2									
MOD.	ML12 DG H1	ML18 DG H1	ML25 DG H1	ML31 DG H1	ML37 DG H1					
Precio Price Prix	H1									
Medidas / Measures / Mesures / [mm]	1250 x 885	1875 x 885	2500 x 885	3125 x 885	3750 x 885					
Sin costados / Without sides / Sans joues	x 2050 mm.									
T°. Prod. Aplic. Prod. T°. Applic. T°. (°C) Temp. Prod. Temp. Appliq.	M0: -1/+4°C -1/+1°C M1: -1/+5°C 0/+2°C M2: -1/+7°C +2/+4°C H1: +1/+10°C +4/+6°C									
Clase Climática Climatic class (°C) Classe climatique	3 / 25°C									
Tensión/Frecuencia Electrical data Tension électrique	230V/1ph/50Hz									
Controlador Controller Régulateur	Digital									
Material Material (EXT/INT) Matériel	Acero galvanizado plastificado / Plastified galvanised steel / Acier galvanisé plastifié									
Aislamiento Isolation [mm] Isolation	40kg/m ³ / Free CFC's / Zero ODP-GWP									
Capacidad Capacity [L] Capacité	803	1204	1605	2006	2408					
Superficie exposición Surface exhibition [x m ²] Surface d'exposition	2,76	4,13	5,51	6,80	8,30					
Niveles Exposición Exposition Levels Niveaux d'exposition	M0, M1, M2: 4+Expos. H1: 3+Expos.									
Costados (2) Sides (2) [mm] Joues (2)	40 + 40									
Puertas Doors Portes	2	3	4	5	6					
Sistema de frío Cooling System Système de froid	Ventilado / Ventilated / Ventilé									
Desescarche Defrost Dégivrage	Automático / Automatic / Automatique									
Evaporación Evaporation Évaporation	Forzada / Forced / Ventilé									
Potencia Power [W] Puissance	-									
Potencia frig. Cooling capacity [W A -10°C] Puissance Frig.	M0: 986 M2: 773	M1: 895 H1: 638	M0: 1479 M2: 1159	M1: 1343 H1: 956	M0: 1973 M2: 1545	M1: 1790 H1: 1275	M0: 2466 M2: 1931	M1: 2238 H1: 1594	M0: 2959 M2: 2318	M1: 2685 H1: 1913
Consumo Consumption [kWh/ 24h] Consommation	-									
Refrigerante Refrigerant Gaz	FREON									
Colores estándar Standard colors Couleurs standard	Ext. Estándar / Standar / Standard			Int. Estándar / Standar / Standard						
	Blanco/White/ Blanc	Ral 1015	Ral 1018	Blanco/White/ Blanc	Negro/Black/ Noir	Ral 7016				
	Ral 2003	Ral 3003	Ral 3020							
	Ral 5015	Ral 5017	Ral 5011							
	Ral 6002	Ral 6018	Ral 6019							
	Ral 7035	Ral 7037	Ral 7042							
	Ral 7016	Ral 9006	Negro/Black/ Noir							
Laterales disponibles Available sides Joues disponibles				Laterales / Sides / Joues						
				No Incluidos / Not includes / Non inclus						
Opciones pág. 426-427 Options pages 426-427 Options pages 426-427										
						Lateral Espejo Mirror end panels Joue Miroir	Lat. Panorámico Panoramic end panels Joue panoramique	Lateral Display Display end panels Joue Display		

Serie / Series / Série **MDG (PORTLAND)**

+Info: www.infrico.com

ML25DG H1



**Nuevo
paragolpes
frontal**

**New
front
bumper**

**Nouveau
pare-chocs
frontale**



ML25DG M2

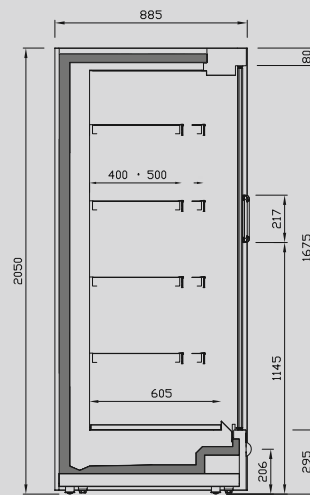

ML DG M0/M1/M2

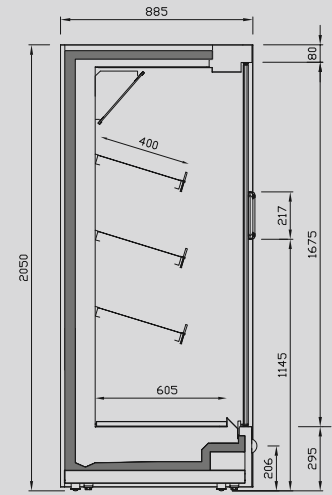

ML DG H1









Mural remota de refrigeración cerradas

Remote refrigeration doors multideck

Murales de réfrigération fermée groupe à distance

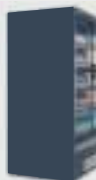

MODELO MODELE MODÈLE										
Precio Price Prix	M0									
MOD.	ML12 DG22 M1	ML18 DG22 M1	ML25 DG22 M1	ML31 DG22 M1	ML37 DG22 M1					
Precio Price Prix	M1									
MOD.	ML12 DG22 M2	ML18 DG22 M2	ML25 DG22 M2	ML31 DG22 M2	ML37 DG22 M2					
Precio Price Prix	M2									
MOD.	ML12 DG22 H1	ML18 DG22 H1	ML25 DG22 H1	ML31 DG22 H1	ML37 DG22 H1					
Precio Price Prix	H1									
Medidas / Measures / Mesures / [mm] Sin costados / Without sides / Sans joues	1250 x 885 x 2200 mm.	1875 x 885 x 2200 mm.	2500 x 885 x 2200 mm.	3125 x 885 x 2200 mm.	3750 x 885 x 2200 mm.					
T°. Prod. Aplic. Prod. T°. Applic. T°. (°C) Temp. Prod. Temp. Appliq.	M0: -1/+4°C -1/+1°C M1: -1/+5°C 0/+2°C M2: -1/+7°C +2/+4°C H1: +1/+10°C +4/+6°C									
Clase Climática Climatic class (°C) Classe climatique	3 / 25°C									
Tensión/Frecuencia Electrical data Tension électrique	230V/1ph/50Hz									
Controlador Controller Régulateur	Digital									
Material Material Matériel [EXT/INT]	Acero galvanizado plastificado / Plastified galvanised steel / Acier galvanisé plastifié									
Aislamiento Isolation Isolation [mm]	40kg/m ³ / Free CFC's / Zero ODP-GWP									
Capacidad Capacity Capacité [L]	849	1273	1698	2122	2546					
Superficie exposición Surface exhibition [x m ²] Surface d'exposition	3,26	4,88	6,51	8,14	9,7					
Niveles Exposición Exposition Levels Niveaux d'exposition	M0, M1, M2: 5+Expos. H1: 4+Expos.									
Costados [2] Sides [2] Joues [2] [mm]	40 + 40									
Puertas Doors Portes	2	3	4	5	6					
Sistema de frío Cooling System Système de froid	Ventilado / Ventilated / Ventilé									
Desescarche Defrost Dégivrage	Automático / Automatic / Automatique									
Evaporación Evaporation Évaporation	Forzada / Forced / Ventilé									
Potencia Power Puissance [W]	-									
Potencia frig. Cooling capacity Puissance Frig. [W A -10°C]	M0: 1018 M2: 815	M1: 928 H1: 683	M0: 1596 M2: 1223	M1: 1391 H1: 1024	M0: 2035 M2: 1630	M1: 1855 H1: 1365	M0: 2544 M2: 2041	M1: 2319 H1: 1706	M0: 3053 M2: 2445	M1: 2783 H1: 2048
Consumo Consumption Consommation [kWh/ 24h]	-									
Refrigerante Refrigerant Gaz	FREON									
Colores estándar Standard colors Couleurs standard	Ext. Estándar / Standar / Standard		Int. Estándar / Standar / Standard			 Lateral Espejo Mirror end panels Joue Miroir	 Lat. Panorámico Panoramic end panels Joue panoramique	 Lateral Display Display end panels Joue Display		
Laterales disponibles Available sides Joues disponibles	Blanco/White/ Blanc	Ral 1015	Ral 1018	Blanco/White/ Blanc	Negro/Black/ Noir				Ral 7016	
	Ral 2003	Ral 3003	Ral 3020							
	Ral 5015	Ral 5017	Ral 5011							
	Ral 6002	Ral 6018	Ral 6019							
	Ral 7035	Ral 7037	Ral 7042							
Opciones pág. 426-427 Options pages 426-427 Options pages 426-427	Ral 7016	Ral 9006	Negro/Black/ Noir	No incluidos / Not includes / Non inlues						

Serie / Series / Série **MDG (PORTLAND)**

+Info: www.infrico.com

ML37DG22 M2



ML37DG22 M2

Lateral panorámico
Panoramic side panel
Joue panoramique

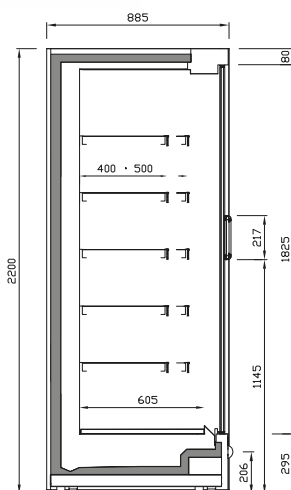

ML DG22 MO/M1/M2

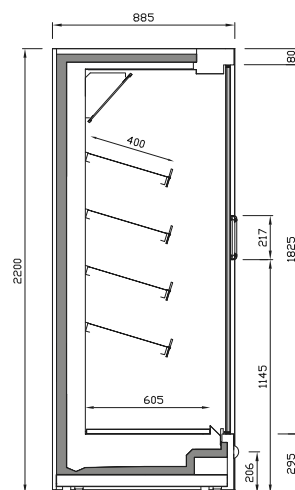

ML DG22 H1



Mural remota de refrigeración cerradas

Remote refrigeration doors multideck

Murales de réfrigération fermée groupe à distance



MODELO MODELE MODÈLE																										
Precio Price Prix	M0																									
MOD.	MX12 DG M1	MX18 DG M1	MX25 DG M1	MX31 DG M1	MX37 DG M1																					
Precio Price Prix	M1																									
MOD.	MX12 DG M2	MX18 DG M2	MX25 DG M2	MX31 DG M2	MX37 DG M2																					
Precio Price Prix	M2																									
MOD.	MX12 DG H1	MX18 DG H1	MX25 DG H1	MX31 DG H1	MX37 DG H1																					
Precio Price Prix	H1																									
Medidas / Measures / Mesures / [mm] Sin costados / Without sides / Sans joues	1250 x 1085 x 2050 mm.	1875 x 1085 x 2050 mm.	2500 x 1085 x 2050 mm.	3125 x 1085 x 2050 mm.	3750 x 1085 x 2050 mm.																					
T°. Prod. Aplic. Prod. T°. Applic. T°. [°C] Temp. Prod. Temp. Appliq.	M0: -1/+4°C -1/+1°C M1: -1/+5°C 0/+2°C M2: -1/+7°C +2/+4°C H1: +1/+10°C +4/+6°C																									
Clase Climática Climatic class [°C] Classe climatique	3 / 25°C																									
Tensión/Frecuencia Electrical data Tension électrique	230V/1ph/50Hz																									
Controlador Controller Régulateur	Digital																									
Material Material [EXT/INT] Matériel	Acero galvanizado plastificado / Plastified galvanised steel / Acier galvanisé plastifié																									
Aislamiento Isolation [mm] Isolation	40kg/m ³ / Free CFC's / Zero ODP-GWP																									
Capacidad Capacity [L] Capacité	M0, M1, M2: 1166 H1: 985	M0, M1, M2: 1749 H1: 1478	M0, M1, M2: 2333 H1: 1970	M0, M1, M2: 2916 H1: 2463	M0, M1, M2: 3499 H1: 2955																					
Superficie exposición Surface exhibition [x m ²] Surface d'exposition	M0, M1, M2: 4,01 H1: 3,26	M0, M1, M2: 6,02 H1: 4,90	M0, M1, M2: 8,10 H1: 6,50	M0, M1, M2: 10,1 H1: 8,10	M0, M1, M2: 12,0 H1: 9,80																					
Niveles Exposición Exposition Levels Niveaux d'exposition	M0, M1, M2: 4+Expos. H1: 3+Expos.																									
Costados [2] Sides [2] [mm] Joues [2]	40 + 40																									
Puertas Doors Portes	2	3	4	5	6																					
Sistema de frío Cooling System Système de froid	Ventilado / Ventilated / Ventilé																									
Desescarche Defrost Dégivrage	Automático / Automatic / Automatique																									
Evaporación Evaporation Évaporation	Forzada / Forced / Ventilé																									
Potencia Power [W] Puissance	-																									
Potencia frig. Cooling capacity [W A -10°C] Puissance Frig.	M0: 986 M2: 773	M1: 895 H1: 638	M0: 1479 M2: 1159	M1: 1343 H1: 956	M0: 1973 M2: 1545	M1: 1790 H1: 1275	M0: 2466 M2: 1931	M1: 2238 H1: 1594	M0: 2959 M2: 2318	M1: 2685 H1: 1913																
Consumo Consumption [kWh/ 24h] Consommation	-																									
Refrigerante Refrigerant Gaz	FREON																									
Colores estándar Standard colors Couleurs standard	Ext. Estándar / Standar / Standard		Int. Estándar / Standar / Standard																							
Laterales disponibles Available sides Joues disponibles	<table border="1"> <tr> <td>Blanco/White/ Blanc</td> <td>Ral 1015</td> <td>Ral 1018</td> </tr> <tr> <td>Ral 2003</td> <td>Ral 3003</td> <td>Ral 3020</td> </tr> <tr> <td>Ral 5015</td> <td>Ral 5017</td> <td>Ral 5011</td> </tr> <tr> <td>Ral 6002</td> <td>Ral 6018</td> <td>Ral 6019</td> </tr> <tr> <td>Ral 7035</td> <td>Ral 7037</td> <td>Ral 7042</td> </tr> <tr> <td>Ral 7016</td> <td>Ral 9006</td> <td>Negro/Black/ Noir</td> </tr> </table>		Blanco/White/ Blanc	Ral 1015	Ral 1018	Ral 2003	Ral 3003	Ral 3020	Ral 5015	Ral 5017	Ral 5011	Ral 6002	Ral 6018	Ral 6019	Ral 7035	Ral 7037	Ral 7042	Ral 7016	Ral 9006	Negro/Black/ Noir	<table border="1"> <tr> <td>Blanco/White/ Blanc</td> <td>Negro/Black/ Noir</td> <td>Ral 7016</td> </tr> </table>			Blanco/White/ Blanc	Negro/Black/ Noir	Ral 7016
Blanco/White/ Blanc	Ral 1015	Ral 1018																								
Ral 2003	Ral 3003	Ral 3020																								
Ral 5015	Ral 5017	Ral 5011																								
Ral 6002	Ral 6018	Ral 6019																								
Ral 7035	Ral 7037	Ral 7042																								
Ral 7016	Ral 9006	Negro/Black/ Noir																								
Blanco/White/ Blanc	Negro/Black/ Noir	Ral 7016																								
Opciones pág. 426-427 Options pages 426-427 Options pages 426-427	<table border="1"> <tr> <td colspan="3">No Incluidos / Not includes / Non includes</td> </tr> </table>		No Incluidos / Not includes / Non includes			<table border="1"> <tr> <td></td> <td></td> <td></td> </tr> <tr> <td>Lateral Espejo Mirror end panels Joue Miroir</td> <td>Lat. Panorámico Panoramic end panels Joue panoramique</td> <td>Lateral Display Display end panels Joue Display</td> </tr> </table>						Lateral Espejo Mirror end panels Joue Miroir	Lat. Panorámico Panoramic end panels Joue panoramique	Lateral Display Display end panels Joue Display												
No Incluidos / Not includes / Non includes																										
Lateral Espejo Mirror end panels Joue Miroir	Lat. Panorámico Panoramic end panels Joue panoramique	Lateral Display Display end panels Joue Display																								

Serie / Series / Série **MDG (PORTLAND)**

+Info: www.infrico.com

MX25DG H1



MX37DG M2

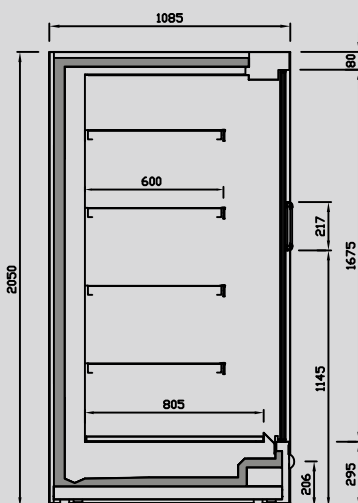

MX DG M0/M1/M2

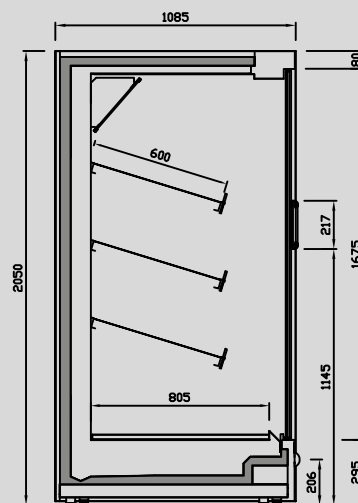

MX DG H1









Mural remota de refrigeración cerradas

Remote refrigeration doors multideck

Murales de réfrigération fermée groupe à distance

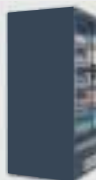

MODELO MODELE MODÈLE										
Precio Price Prix	M0									
MOD.	MX12 DG22 M1	MX18 DG22 M1	MX25 DG22 M1	MX31 DG22 M1	MX37 DG22 M1					
Precio Price Prix	M1									
MOD.	MX12 DG22 M2	MX18 DG22 M2	MX25 DG22 M2	MX31 DG22 M2	MX37 DG22 M2					
Precio Price Prix	M2									
MOD.	MX12 DG22 H1	MX18 DG22 H1	MX25 DG22 H1	MX31 DG22 H1	MX37 DG22 H1					
Precio Price Prix	H1									
Medidas / Measures / Mesures / [mm] Sin costados / Without sides / Sans joues	1250 x 1085 x 2200 mm.	1875 x 1085 x 2200 mm.	2500 x 1085 x 2200 mm.	3125 x 1085 x 2200 mm.	3750 x 1085 x 2200 mm.					
T°. Prod. Aplic. Prod. T°. Applic. T°. [°C] Temp. Prod. Temp. Appliq.	M0: -1/+4°C -1/+1°C M1: -1/+5°C 0/+2°C M2: -1/+7°C +2/+4°C H1: +1/+10°C +4/+6°C									
Clase Climática Climatic class [°C] Classe climatique	3 / 25°C									
Tensión/Frecuencia Electrical data Tension électrique	230V/1ph/50Hz									
Controlador Controller Régulateur	Digital									
Material Material [EXT/INT] Matériel	Acero galvanizado plastificado / Plastified galvanised steel / Acier galvanisé plastifié									
Aislamiento Isolation [mm] Isolation	40kg/m ³ / Free CFC's / Zero ODP-GWP									
Capacidad Capacity [L] Capacité	M0, M1, M2: 951 H1: 801	M0, M1, M2: 1427 H1: 1202	M0, M1, M2: 1903 H1: 1601	M0, M1, M2: 2378 H1: 2003	M0, M1, M2: 2854 H1: 2404					
Superficie exposición Surface exhibition [x m ²] Surface d'exposition	M0, M1, M2: 4,76 H1: 4,01	M0, M1, M2: 7,10 H1: 6,10	M0, M1, M2: 9,50 H1: 8,10	M0, M1, M2: 11,9 H1: 10,1	M0, M1, M2: 14,3 H1: 12,1					
Niveles Exposición Exposition Levels Niveaux d'exposition	M0, M1, M2: 5+Expos. H1: 4+Expos.									
Costados [2] Sides [2] [mm] Joues [2]	40 + 40									
Puertas Doors Portes	2	3	4	5	6					
Sistema de frío Cooling System Système de froid	Ventilado / Ventilated / Ventilé									
Desescarche Defrost Dégivrage	Automático / Automatic / Automatique									
Evaporación Evaporation Évaporation	Forzada / Forced / Ventilé									
Potencia Power [W] Puissance	-									
Potencia fríg. Cooling capacity [W A -10°C] Puissance Frig.	M0: 1018 M2: 816	M1: 928 H1: 683	M0: 1596 M2: 1224	M1: 1391 H1: 1024	M0: 2035 M2: 1633	M1: 1855 H1: 1365	M0: 2544 M2: 2041	M1: 2319 H1: 1706	M0: 3053 M2: 2449	M1: 2783 H1: 2048
Consumo Consumption [kWh/ 24h] Consommation	-									
Refrigerante Refrigerant Gaz	FREON									
Colores estándar Standard colors Couleurs standard	Ext. Estándar / Standar / Standard			Int. Estándar / Standar / Standard						
	Blanco/White/ Blanc	Ral 1015	Ral 1018	Blanco/White/ Blanc	Negro/Black/ Noir	Ral 7016				
	Ral 2003	Ral 3003	Ral 3020	No Incluidos / Not includes / Non inclus						
Laterales disponibles Available sides Joues disponibles	Ral 5015	Ral 5017	Ral 5011	Laterales / Sides / Joues						
	Ral 6002	Ral 6018	Ral 6019							
	Ral 7035	Ral 7037	Ral 7042							
Opciones pág. 426-427 Options pages 426-427 Options pages 426-427	Ral 7016	Ral 9006	Negro/Black/ Noir							
				Lateral Espejo Mirror end panels Joue Miroir	Lat. Panorámico Panoramic end panels Joue panoramique	Lateral Display Display end panels Joue Display				

Serie / Series / Série **MDG (PORTLAND)**

+Info: www.infrico.com



MX37DG22 M2



**Nuevo
paragolpes
frontal**

**New
front
bumper**

**Nouveau
pare-chocs
frontale**



MX37DG22 H1

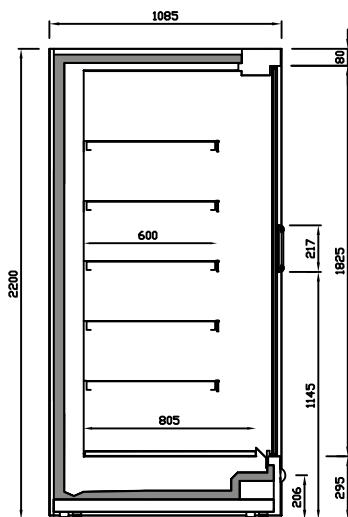

MX DG22 M0/M1/M2

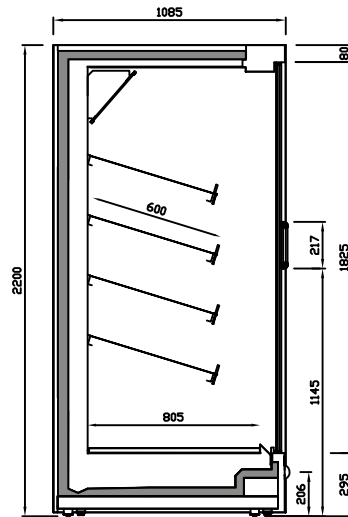

MX DG22 H1



Murales Mixtas de refrigeración cerradas

Mixed refrigeration doors multideck

Murales mixtes fermées groupe à distance

MODELO MODELE MODÈLE				
Precio Price Prix	M1			
MOD.	MS12 DGU M2	MS18 DGU M2	MS25 DGU M2	MS37 DGU M2
Precio Price Prix	M2			
MOD.	MS12 DGU H1	MS18 DGU H1	MS25 DGU H1	MS37 DGU H1
Precio Price Prix	H1			
Medidas / Measures / Mesures / (mm)	1250 x 680 x 2050 mm.	1875 x 680 x 2050 mm.	2500 x 680 x 2050 mm.	3750 x 680 x 2050 mm.
Sin costados / Without sides / Sans joues				
T°. Prod. Aplic. Prod. T°. Applic. T°. (°C) Temp. Prod. Temp. Appliq.	M1: -1/+5°C 0/+2°C M2: -1/+7°C +2/+4°C H1: +1/+10°C +4/+6°C			
Clase Climática Climatic class Classe climatique (°C)	3 / 25°C			
Tensión/Frecuencia Electrical data Tension électrique	230V/1ph/50Hz			
Controlador Controller Régulateur	Digital			
Material Material Matériel (EXT/INT)	Acero galvanizado plastificado / Plastified galvanised steel / Acier galvanisé plastifié			
Aislamiento Isolation Isolation (mm)	40kg/m ³ / Free CFC's / Zero ODP-GWP			
Capacidad Capacity Capacité (L)	M1, M2: 401 H1: 326	M1, M2: 602 H1: 489	M1, M2: 803 H1: 653	M1, M2: 1204 H1: 979
Superficie exposición Surface exhibition Surface d'exposition (x m ²)	M1, M2: 2,01 H1: 1,64	M1, M2: 3,02 H1: 2,46	M1, M2: 4,02 H1: 3,27	M1, M2: 6,04 H1: 4,91
Niveles Exposición Exposition Levels Niveaux d'exposition	M1, M2: 4+Expos. H1: 3+Expos.			
Costados (2) Sides (2) Joues (2) (mm)	40 + 40			
Puertas Doors Portes	2	3	4	6
Sistema de frío Cooling System Système de froid	Ventilado / Ventilated / Ventilé			
Desescarche Defrost Dégivrage	Automático / Automatic / Automatique			
Evaporación Evaporation Évaporation	Forzada / Forced / Ventilé			
Potencia Power Puissance (W)	M1: 665 M2: 665 H1: 665	M1: 772 M2: 772 H1: 772	M1: 1147 M2: 1147 H1: 1147	M1: 2270 M2: 2270 H1: 2270
Potencia frig. Cooling capacity Puissance Frig. (W A -10°C)	-			
Consumo Consumption Consommation (kWh/ 24h)	M1: 11.7 M2: 10.9 H1: 10.4	M1: 13.1 M2: 12.6 H1: 12.0	M1: 19.8 M2: 18.7 H1: 17.8	M1: 38.1 M2: 37.1 H1: 35.41
Refrigerante Refrigerant Gaz	R290			
Colores estándar Standar colors Couleurs standard	Int. Estándar / Standar / Standard		Laterales / Sides / Joues	
	Blanco/White/ Blanc	Negro/Black/ Noir	Ral 7016	No Incluidos / Not includes / Non inclus
Laterales disponibles Available sides Joues disponibles	Ext. Estándar / Standar / Standard			 Lateral Espejo Mirror end panels Joue Miroir
	Blanco/White/ Blanc	Ral 1015	Ral 1018	
Opciones pág. 426-427 Options pages 426-427 Options pages 426-427	Ral 2003	Ral 3003	Ral 3020	 Lateral Display Display end panels Joue Display
	Ral 5015	Ral 5017	Ral 5011	
	Ral 6002	Ral 6018	Ral 6019	
	Ral 7035	Ral 7037	Ral 7042	
	Ral 7016	Ral 9006	Negro/Black/ Noir	

NEW

Series / Série **MDGU (DETROIT)**

+Info: www.infrico.com

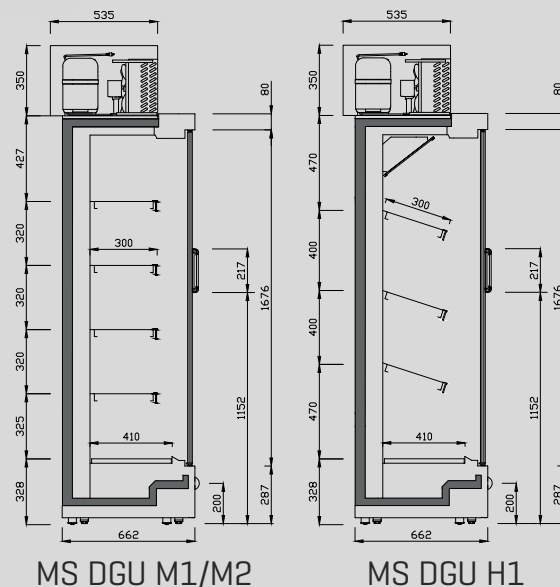

NEW

Series / Série **MDGU (DETROIT)**

+Info: www.infrico.com



MN25DGU H1



**Nuevo
paragolpes
frontal**

**New
front
bumper**

**Nouveau
pare-chocs
frontale**



MN37DGU M2

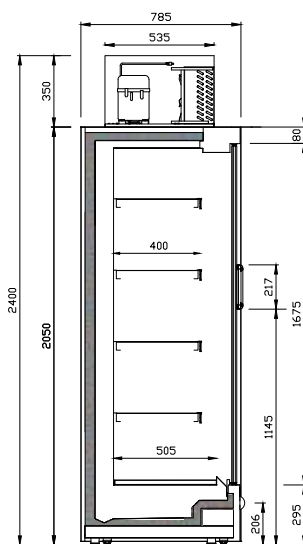

MN DGU M1/M2

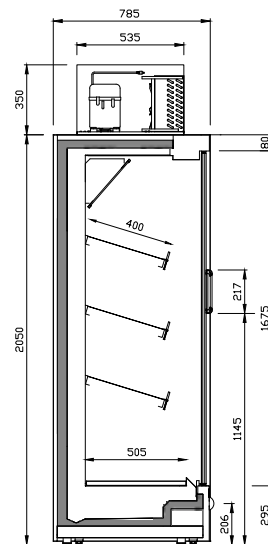

MN DGU H1



Serie / Series / Série **MDGU (DETROIT)**

+Info: www.infrico.com

ML37DGU M2



**Nuevo
paragolpes
frontal**

**New
front
bumper**

**Nouveau
pare-chocs
frontale**



ML25DGU H1

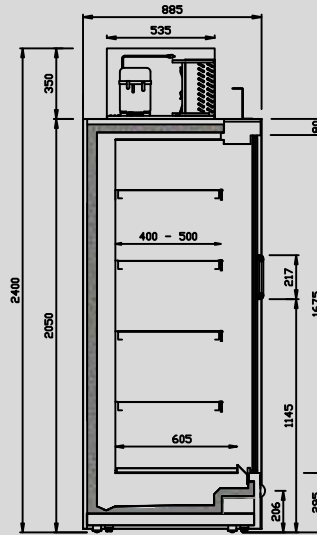

ML DGU M1/M2

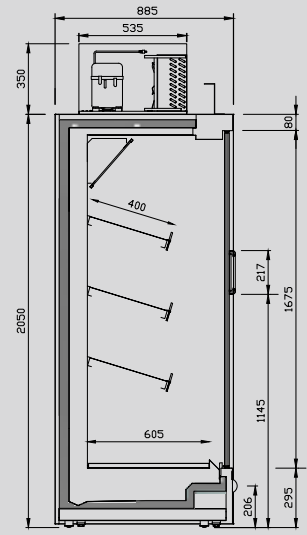

ML DGU H1



Reservados todos los derechos. No se permite la explotación económica ni la transformación de esta obra. Queda permitida la impresión en su totalidad. Reservados todos los derechos. No se permite la explotación económica ni la transformación de esta obra. Queda permitida la impresión en su totalidad. Reservados todos los derechos. No se permite la explotación económica ni la transformación de esta obra. Queda permitida la impresión en su totalidad.

Serie / Series / Série **MDGU (DETROIT)**

+Info: www.infrico.com

ML37DGU22 M2



ML25DGU22 H1

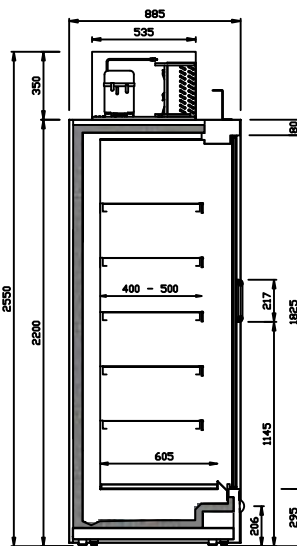

ML DGU22 M1/M2

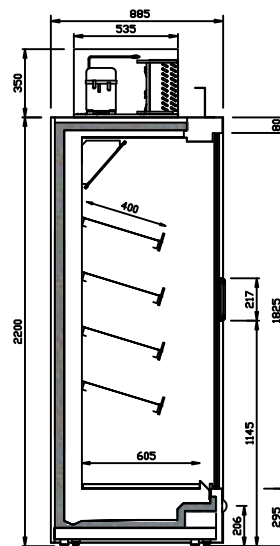

ML DGU22 H1



Mural remota de refrigeración abierta frente bajo

Remote refrigeration open low front multidecks

Murale de réfrigération ouverte groupe à distance avec frontal bas

N: 785

MODELO MODELE MODÈLE						
Precio Price Prix	M1					
MOD.	MN9 PB M2	MN12 PB M2	MN18 PB M2	MN25 PB M2	MN37 PB M2	
Precio Price Prix	M2					
MOD.	MN9 PB H1	MN12 PB H1	MN18 PB H1	MN25 PB H1	MN37 PB H1	
Precio Price Prix	H1					
Medidas / Measures / Mesures / (mm)	938 x 785	1250 x 785	1875 x 785	2500 x 785	3750 x 785	
Sin costados / Without sides / Sans joues	x 2050 mm.					
T°. Prod. Aplic. Prod. T°. Applic. T°. (°C) Temp. Prod. Temp. Appliq.	M1: -1/+5°C 0/+2°C M2: -1/+7°C +2/+4°C H1: +1/+10°C +4/+6°C					
Clase Climática Climatic class Classe climatique (°C)	3 / 25°C					
Tensión/Frecuencia Electrical data Tension électrique	230V/1ph/50Hz					
Controlador Controller Régulateur	Digital					
Material Material Matériel (EXT/INT)	Acero galvanizado plastificado / Plastified galvanised steel / Acier galvanisé plastifié					
Aislamiento Isolation Isolation (mm)	40kg/m ³ / Free CFC's / Zero ODP-GWP					
Capacidad Capacity Capacité (L)	M1, M2: 575 H1: 492	M1, M2: 766 H1: 655	M1, M2: 1149 H1: 983	M1, M2: 1533 H1: 1310	M1, M2: 2299 H1: 1965	
Superficie exposición Surface exhibition Surface d'exposition (x m ²)	M1, M2: 1,98 H1: 1,60	M1, M2: 2,64 H1: 2,14	M1, M2: 3,96 H1: 3,21	M1, M2: 5,28 H1: 4,28	M1, M2: 7,91 H1: 6,41	
Niveles Exposición Exposition Levels Niveaux d'exposition	M1, M2: 4+Expos. H1: 3+Expos.					
Costados (2) Sides (2) Joues (2) (mm)	40 + 40					
Puertas Doors Portes	-					
Sistema de frío Cooling System Système de froid	Ventilado / Ventilated / Ventilé					
Desescarche Defrost Dégivrage	Automático / Automatic / Automatique					
Evaporación Evaporation Évaporation	Forzada / Forced / Ventilé					
Potencia Power Puissance (W)	-					
Potencia frig. Cooling capacity Puissance Frig. (W A -10°C)	M1: 1780 M2: 1636 H1: 1366	M1: 2373 M2: 2180 H1: 1820	M1: 3559 M2: 3270 H1: 2730	M1: 4745 M2: 4360 H1: 3640	M1: 7118 M2: 6540 H1: 5460	
Consumo Consumption Consommation (kWh/ 24h)	-					
Refrigerante Refrigerant Gaz	FREON					
Colores estándar Standar colors Couleurs standard	Int. Estándar / Standar / Standard		Laterales / Sides / Joues			
	Blanco/White/ Blanc	Negro/Black/ Noir	Ral 7016	No Incluidos / Not includes / Non inclus		
Laterales disponibles Available sides Joues disponibles	Ext. Estándar / Standar / Standard					
	Blanco/White/ Blanc	Ral 1015	Ral 1018			
Opciones pág. 426-427 Options pages 426-427 Options pages 426-427	Ral 2003	Ral 3003	Ral 3020			
	Ral 5015	Ral 5017	Ral 5011			
	Ral 6002	Ral 6018	Ral 6019			
	Ral 7035	Ral 7037	Ral 7042			
	Ral 7016	Ral 9006	Negro/Black/ Noir			

Serie / Series / Série **MPB (OSLO)**

+Info: www.infrico.com

MN25PB H1



**Nuevo
paragolpes
frontal**

**New
front
bumper**

**Nouveau
pare-chocs
frontale**



MN37PB M2

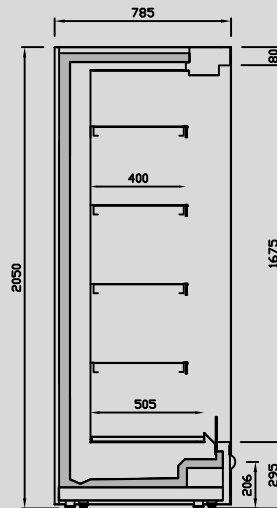

MN PB M1/M2

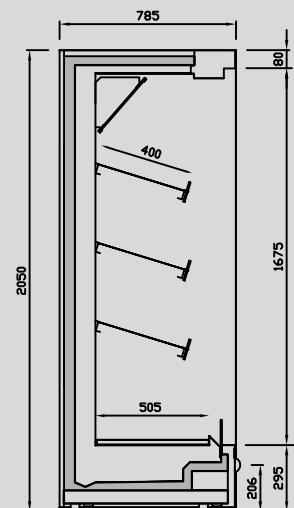

MN PB H1











Mural remota de refrigeración abierta frente bajo

Remote refrigeration open low front multidecks

Murale de réfrigération ouverte groupe à distance avec frontal bas



MODELO MODELE MODÈLE						
Precio Price Prix	M1					
MOD.	MN9 PB22 M2	MN12 PB22 M2	MN18 PB22 M2	MN25 PB22 M2	MN37 PB22 M2	
Precio Price Prix	M2					
MOD.	MN9 PB22 H1	MN12 PB22 H1	MN18 PB22 H1	MN25 PB22 H1	MN37 PB22 H1	
Precio Price Prix	H1					
Medidas / Measures / Mesures / (mm)	938 x 785 x 2200 mm.	1250 x 785 x 2200 mm.	1875 x 785 x 2200 mm.	2500 x 785 x 2200 mm.	3750 x 785 x 2200 mm.	
Sin costados / Without sides / Sans joues						
T°. Prod. Aplic. Prod. T°. Applic. T°. (°C) Temp. Prod. Temp. Appliq.	M1: -1/+5°C 0/+2°C M2: -1/+7°C +2/+4°C H1: +1/+10°C +4/+6°C					
Clase Climática Climatic class Classe climatique (°C)	3 / 25°C					
Tensión/Frecuencia Electrical data Tension électrique	230V/1ph/50Hz					
Controlador Controller Régulateur	Digital					
Material Material Matériel (EXT/INT)	Acero galvanizado plastificado / Plastified galvanised steel / Acier galvanisé plastifié					
Aislamiento Isolation Isolation (mm)	40kg/m ³ / Free CFC's / Zero ODP-GWP					
Capacidad Capacity Capacité (L)	M1, M2: 579 H1: 496	M1, M2: 771 H1: 660	M1, M2: 1156 H1: 991	M1, M2: 1542 H1: 1322	M1, M2: 2313 H1: 1983	
Superficie exposición Surface exhibition Surface d'exposition (x m ²)	M1, M2: 2,35 H1: 1,95	M1, M2: 3,13 H1: 2,63	M1, M2: 4,70 H1: 3,95	M1, M2: 6,30 H1: 5,30	M1, M2: 9,40 H1: 7,90	
Niveles Exposición Exposition Levels Niveaux d'exposition	M1, M2: 5+Expos. H1: 4+Expos.					
Costados (2) Sides (2) Joues (2) (mm)	40 + 40					
Puertas Doors Portes	-					
Sistema de frío Cooling System Système de froid	Ventilado / Ventilated / Ventilé					
Desescarche Defrost Dégivrage	Automático / Automatic / Automatique					
Evaporación Evaporation Évaporation	Forzada / Forced / Ventilé					
Potencia Power Puissance (W)	-					
Potencia frig. Cooling capacity Puissance Frig. (W A -10°C)	M1: 2092 M2: 1907 H1: 1521	M1: 2788 M2: 2541 H1: 2028	M1: 4181 M2: 3812 H1: 3041	M1: 5575 M2: 5083 H1: 4055	M1: 8363 M2: 7624 H1: 6083	
Consumo Consumption Consommation (kWh/ 24h)	-					
Refrigerante Refrigerant Gaz	FREON					
Colores estándar Standar colors Couleurs standard	Int. Estándar / Standar / Standard		Laterales / Sides / Joues			
	Blanco/White/ Blanc	Negro/Black/ Noir	Ral 7016	No Incluidos / Not includes / Non inclus		
Laterales disponibles Available sides Joues disponibles	Ext. Estándar / Standar / Standard					
	Blanco/White/ Blanc	Ral 1015	Ral 1018			
Opciones pág. 426-427 Options pages 426-427 Options pages 426-427	Ral 2003	Ral 3003	Ral 3020			
	Ral 5015	Ral 5017	Ral 5011			
	Ral 6002	Ral 6018	Ral 6019			
	Ral 7035	Ral 7037	Ral 7042			
	Ral 7016	Ral 9006	Negro/Black/ Noir			
						
			Lateral Espejo Mirror end panels Joue Miroir	Lat. Panorámico Panoramic end panels Joue panoramique	Lateral Display Display end panels Joue Display	

Serie / Series / Série **MPB (OSLO)**

+Info: www.infrico.com

MN37PB22 M2



MN25PB22 H1

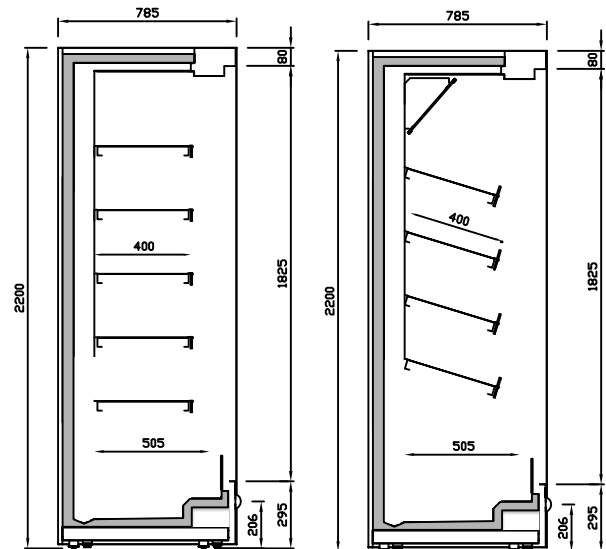

MN PB22 M1/M2

MN PB22 H1



Mural remota de refrigeración abierta frente bajo

Remote refrigeration open low front multidecks

Murale de réfrigération ouverte groupe à distance avec frontal bas



MODELO MODELE MODÈLE						
Precio Price Prix	M1					
MOD.	ML9 PB M2	ML12 PB M2	ML18 PB M2	ML25 PB M2	ML31 PB M2	ML37 PB M2
Precio Price Prix	M2					
MOD.	ML9 PB H1	ML12 PB H1	ML18 PB H1	ML25 PB H1	ML31 PB H1	ML37 PB H1
Precio Price Prix	H1					
Medidas / Measures / Mesures / (mm)	938 x 885 x 2050 mm.	1250 x 885 x 2050 mm.	1875 x 885 x 2050 mm.	2500 x 885 x 2050 mm.	3125 x 885 x 2050 mm.	3750 x 885 x 2050 mm.
Sin costados / Without sides / Sans joues						
T°. Prod. Aplic. Prod. T°. Applic. T°. (°C) Temp. Prod. Temp. Appliq.	M1: -1/+5°C 0/+2°C M2: -1/+7°C +2/+4°C H1: +1/+10°C +4/+6°C					
Clase Climática Climatic class Classe climatique (°C)	3 / 25°C					
Tensión/Frecuencia Electrical data Tension électrique	230V/1ph/50Hz					
Controlador Controller Régulateur	Digital					
Material Material Matériel (EXT/INT)	Acero galvanizado plastificado / Plastified galvanised steel / Acier galvanisé plastifié					
Aislamiento Isolation Isolation (mm)	40kg/m ³ / Free CFC's / Zero ODP-GWP					
Capacidad Capacity Capacité (L)	M1, M2: 602 H1: 520	M1, M2: 803 H1: 701	M1, M2: 1204 H1: 1143	M1, M2: 1605 H1: 1390	M1, M2: 2012 H1: 1650	M1, M2: 2408 H1: 2110
Superficie exposición Surface exhibition Surface d'exposition (x m ²)	M1, M2: 2,07 H1: 1,69	M1, M2: 2,76 H1: 2,26	M1, M2: 4,10 H1: 3,40	M1, M2: 5,50 H1: 4,50	M1, M2: 6,80 H1: 5,60	M1, M2: 8,30 H1: 6,70
Niveles Exposición Exposition Levels Niveaux d'exposition	M1, M2: 4+Expos. H1: 3+Expos.					
Costados (2) Sides (2) Joues (2) (mm)	40 + 40					
Puertas Doors Portes	-					
Sistema de frío Cooling System Système de froid	Ventilado / Ventilated / Ventilé					
Desescarche Defrost Dégivrage	Automático / Automatic / Automatique					
Evaporación Evaporation Évaporation	Forzada / Forced / Ventilé					
Potencia Power Puissance (W)	-					
Potencia frig. Cooling capacity Puissance Frig. (W A -10°C)	M1: 1696 M2: 1558 H1: 1300	M1: 2260 M2: 2076 H1: 1733	M1: 3190 M2: 3114 H1: 2599	M1: 4250 M2: 4153 H1: 3465	M1: 5650 M2: 5191 H1: 4331	M1: 6780 M2: 6229 H1: 5198
Consumo Consumption Consommation (kWh/ 24h)	-					
Refrigerante Refrigerant Gaz	FREON					
Colores estándar Standar colors Couleurs standard	Int. Estándar / Standar / Standard		Laterales / Sides / Joues			
	Blanco/White/ Blanc	Negro/Black/ Noir	Ral 7016	No Incluidos / Not includes / Non inclus		
Laterales disponibles Available sides Joues disponibles	Ext. Estándar / Standar / Standard					
	Blanco/White/ Blanc	Ral 1015	Ral 1018			
Opciones pág. 426-427 Options pages 426-427 Options pages 426-427	Ral 2003	Ral 3003	Ral 3020			
	Ral 5015	Ral 5017	Ral 5011			
	Ral 6002	Ral 6018	Ral 6019			
	Ral 7035	Ral 7037	Ral 7042			
	Ral 7016	Ral 9006	Negro/Black/ Noir			

Serie / Series / Série **MPB (OSLO)**

+Info: www.infrico.com

ML37PB M2



ML25PB H1

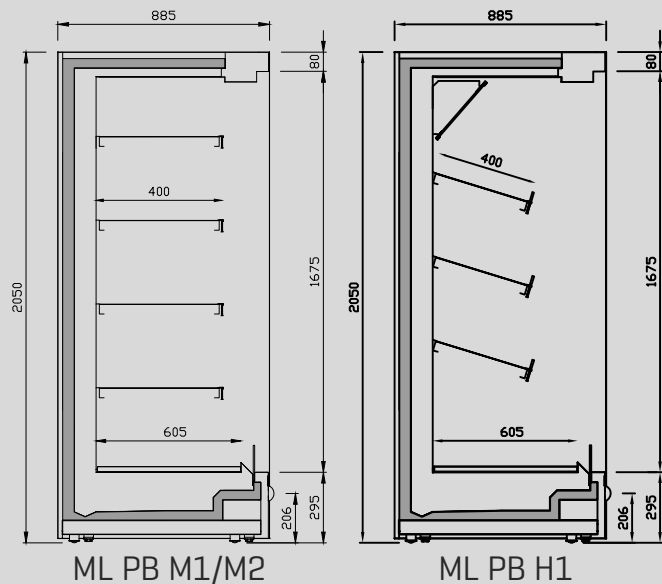

Serie / Series / Série **MPB (OSLO)**

+Info: www.infrico.com

ML25PB22 H1



ML37PB22 M2

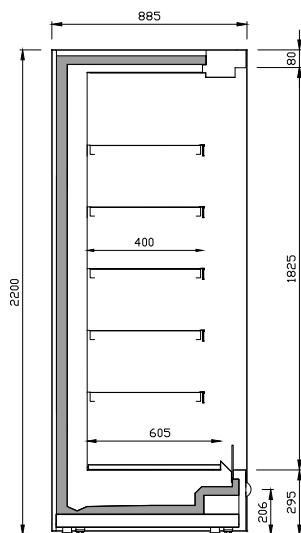

ML PB22 M1/M2

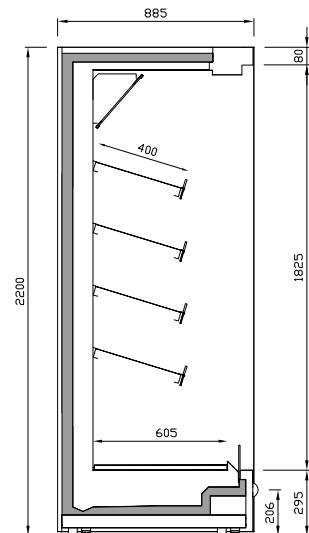

ML PB22 H1



Mural remota de refrigeración abierta frente bajo

Remote refrigeration open low front multidecks

Murale de réfrigération ouverte groupe à distance avec frontal bas



MODELO MODELE MODÈLE					
Precio Price Prix	M2				
MOD.	MX12 PB H1	MX18 PB H1	MX25 PB H1	MX31 PB H1	MX37 PB H1
Precio Price Prix	H1				
Medidas / Measures / Mesures / (mm)	1250 x 1085	1875 x 1085	2500 x 1085	3125 x 1085	3750 x 1085
Sin costados / Without sides / Sans joues	x 2050 mm.				
T°. Prod. Aplic. Prod. T°. Applic. T°. (°C) Temp. Prod. Temp. Appliq.	M2: -1/+7°C +2/+4°C H1: +1/+10°C +4/+6°C				
Clase Climática Climatic class Classe climatique (°C)	3 / 25°C				
Tensión/Frecuencia Electrical data Tension électrique	230V/1ph/50Hz				
Controlador Controller Régulateur	Digital				
Material Material Matériel (EXT/INT)	Acero galvanizado plastificado / Plastified galvanised steel / Acier galvanisé plastifié				
Aislamiento Isolation Isolation (mm)	40kg/m ³ / Free CFC's / Zero ODP-GWP				
Capacidad Capacity Capacité (L)	M2: 801 H1: 651	M2: 1202 H1: 976	M2: 1603 H1: 1303	M2: 2003 H1: 1628	M2: 2404 H1: 1954
Superficie exposición Surface exhibition Surface d'exposition (x m ²)	M2: 4,01 H1: 3,26	M2: 6,01 H1: 4,28	M2: 8,01 H1: 6,50	M2: 10,1 H1: 8,20	M2: 12,1 H1: 9,70
Niveles Exposición Exposition Levels Niveaux d'exposition	M2: 4+Expos. H1: 3+Expos.				
Costados (2) Sides (2) Joues (2) (mm)	40 + 40				
Puertas Doors Portes	-				
Sistema de frío Cooling System Système de froid	Ventilado / Ventilated / Ventilé				
Desescarche Defrost Dégivrage	Automático / Automatic / Automatique				
Evaporación Evaporation Évaporation	Forzada / Forced / Ventilé				
Potencia Power Puissance (W)	-				
Potencia frig. Cooling capacity Puissance Frig. (W A -10°C)	M2: 2430 H1: 2028	M2: 3645 H1: 3041	M2: 4860 H1: 4055	M2: 6075 H1: 5069	M2: 7290 H1: 6083
Consumo Consumption Consommation (kWh/ 24h)	-				
Refrigerante Refrigerant Gaz	FREON				
Colores estándar Standar colors Couleurs standard	Int. Estándar / Standar / Standard Blanco/White/ Blanc Negro/Black/ Noir Ral 7016		Laterales / Sides / Joues No Incluidos / Not includes / Non inclus		
Laterales disponibles Available sides Joues disponibles	Ext. Estándar / Standar / Standard Blanco/White/ Blanc Ral 1015 Ral 1018 Ral 2003 Ral 3003 Ral 3020 Ral 5015 Ral 5017 Ral 5011 Ral 6002 Ral 6018 Ral 6019 Ral 7035 Ral 7037 Ral 7042 Ral 7016 Ral 9006 Negro/Black/ Noir				
Opciones pág. 426-427 Options pages 426-427 Options pages 426-427					

MX37PB M2



**Nuevo
paragolpes
frontal**

**New
front
bumper**

**Nouveau
pare-chocs
frontale**



MX25PB H1

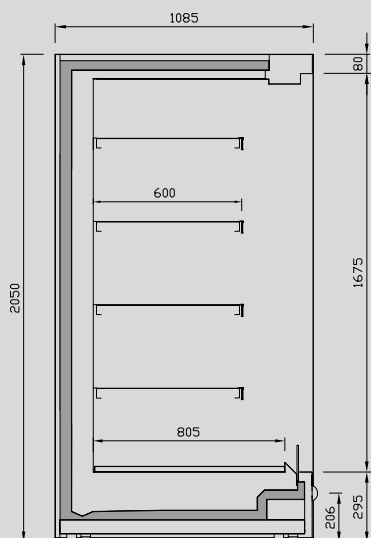

MX PB M2

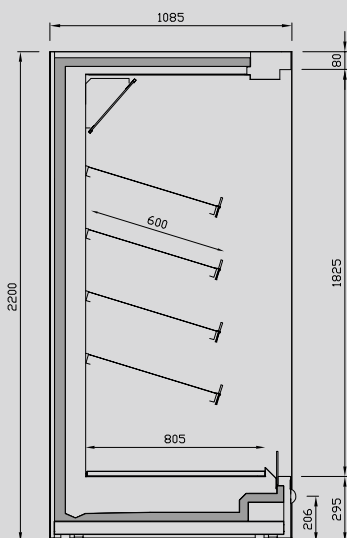

MX PB H1











Mural remota de refrigeración abierta frente bajo

Remote refrigeration open low front multidecks

Murale de réfrigération ouverte groupe à distance avec frontal bas



MODELO MODELE MODÈLE					
Precio Price Prix	M2				
MOD.	MX12 PB22 H1	MX18 PB22 H1	MX25 PB22 H1	MX31 PB22 H1	MX37 PB22 H1
Precio Price Prix	H1				
Medidas / Measures / Mesures / (mm)	1250 x 1085	1875 x 1085	2500 x 1085	3125 x 1085	3750 x 1085
Sin costados / Without sides / Sans joues	x 2200 mm.				
T°. Prod. Aplic. Prod. T°. Applic. T°. (°C) Temp. Prod. Temp. Appliq.	M2: -1/+7°C +2/+4°C H1: +1/+10°C +4/+6°C				
Clase Climática Climatic class Classe climatique (°C)	3 / 25°C				
Tensión/Frecuencia Electrical data Tension électrique	230V/1ph/50Hz				
Controlador Controller Régulateur	Digital				
Material Material Matériel (EXT/INT)	Acero galvanizado plastificado / Plastified galvanised steel / Acier galvanisé plastifié				
Aislamiento Isolation Isolation (mm)	40kg/m ³ / Free CFC's / Zero ODP-GWP				
Capacidad Capacity Capacité (L)	M2: 951 H1: 801	M2: 1427 H1: 1202	M2: 1903 H1: 1603	M2: 2378 H1: 2003	M2: 2854 H1: 2404
Superficie exposición Surface exhibition Surface d'exposition (x m ²)	M2: 4,80 H1: 4,00	M2: 7,10 H1: 6,02	M2: 9,50 H1: 8,10	M2: 11,9 H1: 10,1	M2: 14,3 H1: 12,0
Niveles Exposición Exposition Levels Niveaux d'exposition	M1, M2: 5+Expos. H1: 4+Expos.				
Costados (2) Sides (2) Joues (2) (mm)	40 + 40				
Puertas Doors Portes	-				
Sistema de frío Cooling System Système de froid	Ventilado / Ventilated / Ventilé				
Desescarche Defrost Dégivrage	Automático / Automatic / Automatique				
Evaporación Evaporation Évaporation	Forzada / Forced / Ventilé				
Potencia Power Puissance (W)	-				
Potencia frig. Cooling capacity Puissance Frig. (W A -10°C)	M2: 2833 H1: 2259	M2: 4249 H1: 3388	M2: 5665 H1: 4518	M2: 7081 H1: 5647	M2: 8498 H1: 6776
Consumo Consumption Consommation (kWh/ 24h)	-				
Refrigerante Refrigerant Gaz	FREON				
Colores estándar Standar colors Couleurs standard	Int. Estándar / Standar / Standard Blanco/White/ Blanc Negro/Black/ Noir Ral 7016		Laterales / Sides / Joues No Incluidos / Not includes / Non inclus		
Laterales disponibles Available sides Joues disponibles	Ext. Estándar / Standar / Standard Blanco/White/ Blanc Ral 1015 Ral 1018 Ral 2003 Ral 3003 Ral 3020 Ral 5015 Ral 5017 Ral 5011 Ral 6002 Ral 6018 Ral 6019 Ral 7035 Ral 7037 Ral 7042 Ral 7016 Ral 9006 Negro/Black/ Noir		  		
Opciones pág. 426-427 Options pages 426-427 Options pages 426-427					

Serie / Series / Série **MPB (OSLO)**

+Info: www.infrico.com

MX25PB22 H1



**Nuevo
paragolpes
frontal**

**New
front
bumper**

**Nouveau
pare-chocs
frontale**



MX37PB22 M2

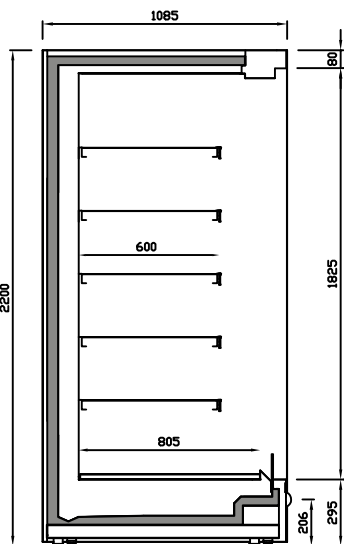

MX PB22 M2

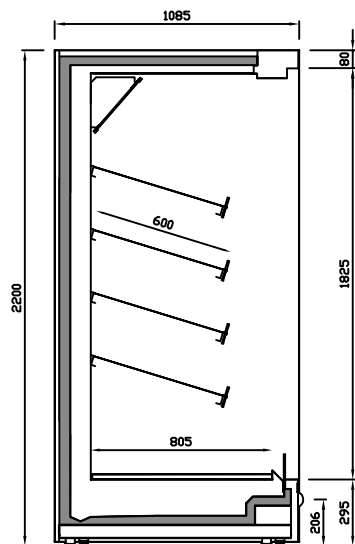

MX PB22 H1







Mural remota de congelación cerrada

Remote freezer full glass doors multidecks

Murale congélation fermée groupe à distance



MODELO MODELE MODÈLE																						
Precio Price Prix	L1																					
MOD.	MN2P BT22 L1	MN3P BT22 L1	MN4P BT22 L1	MN5P BT22 L1																		
Precio Price Prix	L1																					
Medidas / Measures / Mesures / (mm)	1562 x 780 x 2050 mm.	2343 x 780 x 2050 mm.	3124 x 780 x 2050 mm.	3905 x 780 x 2050 mm.																		
Sin costados / Without sides / Sans joues	1562 x 780 x 2200 mm. [22]	2343 x 780 x 2200 mm. [22]	3124 x 780 x 2200 mm. [22]	3905 x 780 x 2200 mm. [22]																		
T°. Prod. Aplic. Prod. T°. Applic. T°. (°C) Temp. Prod. Temp. Appliq.	L1: -15/-18°C -23/-25°C																					
Clase Climática Climatic class Classe climatique (°C)	3 / 25°C																					
Tensión/Frecuencia Electrical data Tension électrique	230V/1ph/50Hz																					
Controlador Controller Régulateur	Digital																					
Material Material Matériel (EXT/INT)	Acero galvanizado plastificado / Plastified galvanised steel / Acier galvanisé plastifié																					
Aislamiento Isolation Isolation (mm)	40kg/m ³ / Free CFC's / Zero ODP-GWP																					
Capacidad Capacity Capacité (L)	L1: 659 L1 22: 822	L1: 989 L1 22: 1233	L1: 1318 L1 22: 1844	L1: 1648 L1 22: 2055																		
Área refrigerada Refrigerated area Zone réfrigérée (x m ²)	L1: 3,20 L1 22: 3,91	L1: 4,70 L1 22: 5,87	L1: 6,30 L1 22: 7,83	L1: 7,90 L1 22: 9,78																		
Niveles Exposición Exposition Levels Niveaux d'exposition	L1: 4+Expos. L1 22: 5+Expos.																					
Costados [2] Sides [2] Joues [2] (mm)	60 + 60																					
Puertas Doors Portes	2	3	4	5																		
Sistema de frío Cooling System Système de froid	Ventilado / Ventilated / Ventilé																					
Desescarche Defrost Dégivrage	Automático / Automatic / Automatique																					
Evaporación Evaporation Évaporation	Forzada / Forced / Ventilé																					
Potencia Power Puissance (W)	-																					
Potencia frig. Cooling capacity Puissance Frig. (W A -10°C)	L1: 1207 L1 22: 1298	L1: 1809 L1 22: 1947	L1: 2412 L1 22: 2596	L1: 3015 L1 22: 3245																		
Consumo Consumption Consommation (kWh/ 24h)	-																					
Refrigerante Refrigerant Gaz	FREON																					
Colores estándar Standar colors Couleurs standard	Int. Estándar / Standar / Standard <table border="1"> <tr> <td>Blanco/White/ Blanc</td> <td>Negro/Black/ Noir</td> </tr> </table>		Blanco/White/ Blanc	Negro/Black/ Noir	Laterales / Sides / Joues No Incluidos / Not includes / Non inclus																	
Blanco/White/ Blanc	Negro/Black/ Noir																					
Laterales disponibles Available sides Joues disponibles	Ext. Estándar / Standar / Standard <table border="1"> <tr> <td>Blanco/White/ Blanc</td> <td>Ral 1015</td> <td>Ral 1018</td> </tr> <tr> <td>Ral 2003</td> <td>Ral 3003</td> <td>Ral 3020</td> </tr> <tr> <td>Ral 5015</td> <td>Ral 5017</td> <td>Ral 5011</td> </tr> <tr> <td>Ral 6002</td> <td>Ral 6018</td> <td>Ral 6019</td> </tr> <tr> <td>Ral 7035</td> <td>Ral 7037</td> <td>Ral 7042</td> </tr> <tr> <td>Ral 7016</td> <td>Ral 9006</td> <td>Negro/Black/ Noir</td> </tr> </table>		Blanco/White/ Blanc	Ral 1015	Ral 1018	Ral 2003	Ral 3003	Ral 3020	Ral 5015	Ral 5017	Ral 5011	Ral 6002	Ral 6018	Ral 6019	Ral 7035	Ral 7037	Ral 7042	Ral 7016	Ral 9006	Negro/Black/ Noir	 Lateral Espejo Mirror end panels Joue Miroir	
Blanco/White/ Blanc	Ral 1015	Ral 1018																				
Ral 2003	Ral 3003	Ral 3020																				
Ral 5015	Ral 5017	Ral 5011																				
Ral 6002	Ral 6018	Ral 6019																				
Ral 7035	Ral 7037	Ral 7042																				
Ral 7016	Ral 9006	Negro/Black/ Noir																				
Opciones pág. 426-427 Options pages 426-427 Options pages 426-427																						

NEW

Series / Série **MBT (TORONTO)**

+Info: www.infrico.com

MN5P BT22 L1



MN5P BT L1

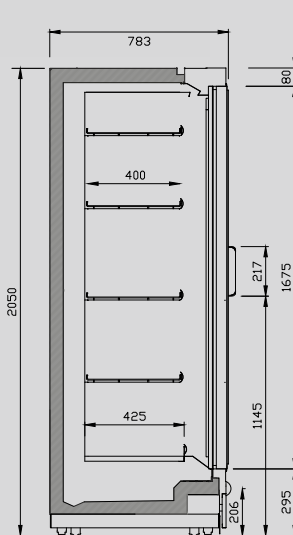

MN BT L1

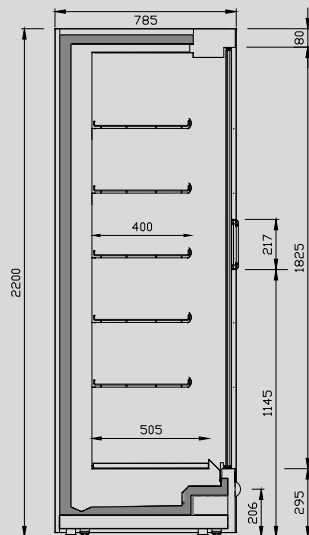

MN BT22 L1







Mural remota de congelación cerrada

Remote freezer full glass doors multidecks

Murale congélation fermée groupe à distance

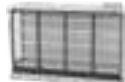
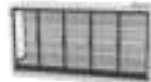

MODELO MODELE MODÈLE																						
Precio Price Prix	L1																					
MOD.	MF2P BT22 L1	MF3P BT22 L1	MF4P BT22 L1	MF5P BT22 L1																		
Precio Price Prix	L1																					
Medidas / Measures / Mesures / (mm)	1562 x 980 x 2050 mm.	2343 x 980 x 2050 mm.	3124 x 980 x 2050 mm.	3905 x 980 x 2050 mm.																		
Sin costados / Without sides / Sans joues	1562 x 980 x 2200 mm. [22]	2343 x 980 x 2200 mm. [22]	3124 x 980 x 2200 mm. [22]	3905 x 980 x 2200 mm. [22]																		
T°. Prod. Aplic. Prod. T°. Applic. T°. (°C) Temp. Prod. Temp. Appliq.	L1: -15/-18°C -23/-25°C																					
Clase Climática Climatic class Classe climatique (°C)	3 / 25°C																					
Tensión/Frecuencia Electrical data Tension électrique	230V/1ph/50Hz																					
Controlador Controller Régulateur	Digital																					
Material Material Matériel (EXT/INT)	Acero galvanizado plastificado / Plastified galvanised steel / Acier galvanisé plastifié																					
Aislamiento Isolation Isolation (mm)	40kg/m ³ / Free CFC's / Zero ODP-GWP																					
Capacidad Capacity Capacité (L)	L1: 1232 L1 22: 1466	L1: 1845 L1 22: 2197	L1: 2460 L1 22: 2929	L1: 3075 L1 22: 3661																		
Área refrigerada Refrigerated area Zone réfrigérée (x m ²)	L1: 4,7 L1 22: 5,7	L1: 7,1 L1 22: 8,5	L1: 9,45 L1 22: 11,3	L1: 11,8 L1 22: 14,2																		
Niveles Exposición Exposition Levels Niveaux d'exposition	L1: 4+Expos. L1 22: 5+Expos.																					
Costados [2] Sides [2] Joues [2] (mm)	60 + 60																					
Puertas Doors Portes	2	3	4	5																		
Sistema de frío Cooling System Système de froid	Ventilado / Ventilated / Ventilé																					
Desescarche Defrost Dégivrage	Automático / Automatic / Automatique																					
Evaporación Evaporation Évaporation	Forzada / Forced / Ventilé																					
Potencia Power Puissance (W)	-																					
Potencia frig. Cooling capacity Puissance Frig. (W A -10°C)	L1: 1245 L1 22: 1336	L1: 1865 L1 22: 2001	L1: 2487 L1 22: 2668	L1: 3108 L1 22: 3335																		
Consumo Consumption Consommation (kWh/ 24h)	-																					
Refrigerante Refrigerant Gaz	FREON																					
Colores estándar Standar colors Couleurs standard	Int. Estándar / Standar / Standard Blanco/White/Blanc Negro/Black/Noir		Laterales / Sides / Joues No Incluidos / Not includes / Non inclus																			
Laterales disponibles Available sides Joues disponibles	Ext. Estándar / Standar / Standard <table border="1"> <tr> <td>Blanco/White/Blanc</td> <td>Ral 1015</td> <td>Ral 1018</td> </tr> <tr> <td>Ral 2003</td> <td>Ral 3003</td> <td>Ral 3020</td> </tr> <tr> <td>Ral 5015</td> <td>Ral 5017</td> <td>Ral 5011</td> </tr> <tr> <td>Ral 6002</td> <td>Ral 6018</td> <td>Ral 6019</td> </tr> <tr> <td>Ral 7035</td> <td>Ral 7037</td> <td>Ral 7042</td> </tr> <tr> <td>Ral 7016</td> <td>Ral 9006</td> <td>Negro/Black/Noir</td> </tr> </table>		Blanco/White/Blanc	Ral 1015	Ral 1018	Ral 2003	Ral 3003	Ral 3020	Ral 5015	Ral 5017	Ral 5011	Ral 6002	Ral 6018	Ral 6019	Ral 7035	Ral 7037	Ral 7042	Ral 7016	Ral 9006	Negro/Black/Noir	 Lateral Espejo Mirror end panels Joue Miroir  Lateral Display Display end panels Joue Display	
Blanco/White/Blanc	Ral 1015	Ral 1018																				
Ral 2003	Ral 3003	Ral 3020																				
Ral 5015	Ral 5017	Ral 5011																				
Ral 6002	Ral 6018	Ral 6019																				
Ral 7035	Ral 7037	Ral 7042																				
Ral 7016	Ral 9006	Negro/Black/Noir																				
Opciones pág. 426-427 Options pages 426-427 Options pages 426-427																						

Serie / Series / Série **MBT (TORONTO)**

+Info: www.infrico.com

MF5P BT L1



MF5P BT22 L1

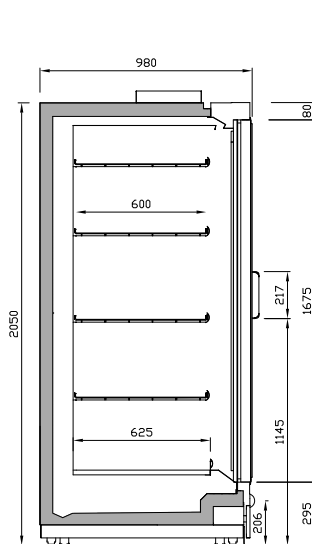

MF BT L1

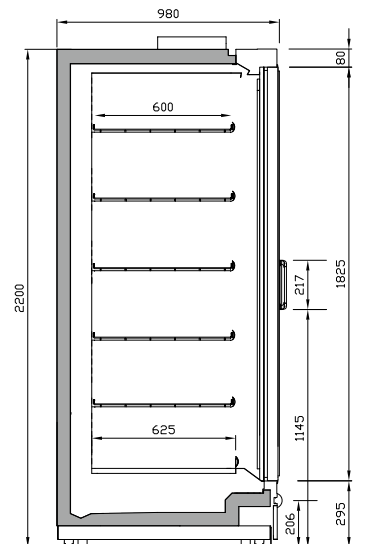

MF BT22 L1



Mural mixta de congelación cerrada

Mixed freezer full glass doors multidecks

Murale mixte congélation fermée



MODELO
MODELE
MODÈLE



MN2P BTU L1



MN3P BTU L1

Precio Price Prix	L1																					
Medidas / Measures / Mesures / [mm] Sin costados / Without sides / Sans joues	1562 x 780 x 2050 mm.	2343 x 780 x 2050 mm.																				
T°. Prod. Aplic. Prod. T°. Applic. T°. [°C] Temp. Prod. Temp. Appliq.	L1: -15/-18°C -23/-25°C																					
Clase Climática Climatic class Classe climatique [°C]	3 / 25°C																					
Tensión/Frecuencia Electrical data Tension électrique	230V/1ph/50Hz																					
Controlador Controller Régulateur	Digital																					
Material Material Matériel [EXT/INT]	Acero galvanizado plastificado / Plastified galvanised steel / Acier galvanisé plastifié																					
Aislamiento Isolation Isolation [mm]	40kg/m ³ / Free CFC's / Zero ODP-GWP																					
Capacidad Capacity Capacité [L]	L1: 648	L1: 973																				
Área refrigerada Refrigerated area Zone réfrigérée [x m ²]	L1: 3,16	L1: 4,70																				
Niveles Exposición Exposition Levels Niveaux d'exposition	L1: 4+Expos.																					
Costados [2] Sides [2] Joues [2] [mm]	60 + 60																					
Puertas Doors Portes	2	3																				
Sistema de frío Cooling System Système de froid	Ventilado / Ventilated / Ventilé																					
Desescarche Defrost Dégivrage	Automático / Automatic / Automatique																					
Evaporación Evaporation Evaporation	Forzada / Forced / Ventilé																					
Potencia Power Puissance [W]	2043	3058																				
Potencia frig. Cooling capacity Puissance Frig. [W A -10°C]	-	-																				
Consumo Consumption Consommation [kWh/ 24h]	29,4	40,4																				
Refrigerante Refrigerant Gaz	R-290																					
Colores estándar Standard colors Couleurs standard	<p>Int. Estándar / Standar / Standard</p> <table border="1"> <tr> <td>Blanco/White/ Blanc</td> <td>Negro/Black/ Noir</td> </tr> </table> <p>Ext. Estándar / Standar / Standard</p> <table border="1"> <tr> <td>Blanco/White/ Blanc</td> <td>Ral 1015</td> <td>Ral 1018</td> </tr> <tr> <td>Ral 2003</td> <td>Ral 3003</td> <td>Ral 3020</td> </tr> <tr> <td>Ral 5015</td> <td>Ral 5017</td> <td>Ral 5011</td> </tr> <tr> <td>Ral 6002</td> <td>Ral 6018</td> <td>Ral 6019</td> </tr> <tr> <td>Ral 7035</td> <td>Ral 7037</td> <td>Ral 7042</td> </tr> <tr> <td>Ral 7016</td> <td>Ral 9006</td> <td>Negro/Black/ Noir</td> </tr> </table>		Blanco/White/ Blanc	Negro/Black/ Noir	Blanco/White/ Blanc	Ral 1015	Ral 1018	Ral 2003	Ral 3003	Ral 3020	Ral 5015	Ral 5017	Ral 5011	Ral 6002	Ral 6018	Ral 6019	Ral 7035	Ral 7037	Ral 7042	Ral 7016	Ral 9006	Negro/Black/ Noir
Blanco/White/ Blanc	Negro/Black/ Noir																					
Blanco/White/ Blanc	Ral 1015	Ral 1018																				
Ral 2003	Ral 3003	Ral 3020																				
Ral 5015	Ral 5017	Ral 5011																				
Ral 6002	Ral 6018	Ral 6019																				
Ral 7035	Ral 7037	Ral 7042																				
Ral 7016	Ral 9006	Negro/Black/ Noir																				
Laterales disponibles Available sides Joues disponibles	<p>Laterales / Sides / Joues</p> <p>No Incluidos / Not includes / Non inclus</p>  <p>Lateral Espejo Mirror end panels Joue Miroir</p>																					
Opciones pág. 426-427 Options pages 426-427 Options pages 426-427																						

NEW

Series / Série **MBTU (MONTREAL)**

+Info: www.infrico.com

MN3P BTU L1



Estantes profundidad 400mm
Shelves 400mm depth
Profondeur des étagères 400mm



Nuevo paragolpes frontal

New front bumper

Nouveau pare-chocs frontale

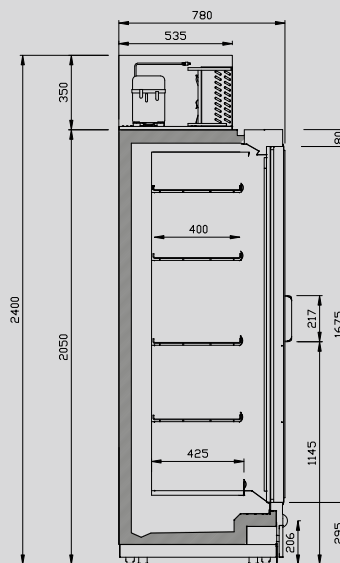





Mural plug in de congelación cerradas

Plug in freezer full glass doors multidecks

Murale de congélation fermée groupe incorporé



MODELO MODELE MODÈLE																					
Precio Price Prix	L1																				
MOD.	MN12 BTPC L1	MN18 BTPC L1	MN25 BTPC L1																		
Precio Price Prix	C L1																				
Medidas Measures [mm] Mesures	1250 x 780 x 2000 mm.	1835 x 780 x 2000 mm.	2500 x 780 x 2000 mm.																		
T°. Prod. Aplic. Prod. T°. Applic. T°. [°C] Temp. Prod. Temp. Appliq.	L1: -15/-18°C -23/-25°C																				
Clase Climática Climatic class Classe climatique [°C]	3 / 25°C																				
Tensión/Frecuencia Electrical data Tension électrique	230V/1ph/50Hz																				
Controlador Controller Régulateur	Digital																				
Material Material [EXT/INT] Matériel	Acero galvanizado plastificado / Plastified galvanised steel / Acier galvanisé plastifié																				
Aislamiento Isolation [mm] Isolation	40kg/m ³ / Free CFC's / Zero ODP-GWP																				
Capacidad Capacity [L] Capacité	664	996	1328																		
Área refrigerada Refrigerated area [x m ²] Zone réfrigérée	2,54	3,81	5,08																		
Niveles Exposición Exposition Levels Niveaux d'exposition	4+Expos.																				
Costados [2] Sides [2] Joues [2] [mm]	60 + 60																				
Puertas Doors Portes	2	3	4																		
Sistema de frío Cooling System Système de froid	Ventilado / Ventilated / Ventilé																				
Desescarche Defrost Dégivrage	Automático / Automatic / Automatique																				
Evaporación Evaporation Évaporation	Forzada / Forced / Ventilé																				
Potencia Power [W] Puissance	1282	1695	2512																		
Potencia frig. Cooling capacity [W A -10°C] Puissance Frig.	-	-	-																		
Consumo Consumption [kWh/ 24h] Consommation	23,1	30,5	45,2																		
Refrigerante Refrigerant Gaz	R-290																				
Colores estándar Standar colors Couleurs standard	Int. Estándar / Standar / Standard <table border="1"> <tr> <td>Blanco/White/ Blanc</td> <td>Negro/Black/ Noir</td> </tr> </table>			Blanco/White/ Blanc	Negro/Black/ Noir																
Blanco/White/ Blanc	Negro/Black/ Noir																				
Laterales disponibles Available sides Joues disponibles	Laterales / Sides / Joues No Incluidos / Not includes / Non inclus																				
Opciones pág. 426-427 Options pages 426-427 Options pages 426-427	Ext. Estándar / Standar / Standard <table border="1"> <tr> <td>Blanco/White/ Blanc</td> <td>Ral 1015</td> <td>Ral 1018</td> </tr> <tr> <td>Ral 2003</td> <td>Ral 3003</td> <td>Ral 3020</td> </tr> <tr> <td>Ral 5015</td> <td>Ral 5017</td> <td>Ral 5011</td> </tr> <tr> <td>Ral 6002</td> <td>Ral 6018</td> <td>Ral 6019</td> </tr> <tr> <td>Ral 7035</td> <td>Ral 7037</td> <td>Ral 7042</td> </tr> <tr> <td>Ral 7016</td> <td>Ral 9006</td> <td>Negro/Black/ Noir</td> </tr> </table>			Blanco/White/ Blanc	Ral 1015	Ral 1018	Ral 2003	Ral 3003	Ral 3020	Ral 5015	Ral 5017	Ral 5011	Ral 6002	Ral 6018	Ral 6019	Ral 7035	Ral 7037	Ral 7042	Ral 7016	Ral 9006	Negro/Black/ Noir
Blanco/White/ Blanc	Ral 1015	Ral 1018																			
Ral 2003	Ral 3003	Ral 3020																			
Ral 5015	Ral 5017	Ral 5011																			
Ral 6002	Ral 6018	Ral 6019																			
Ral 7035	Ral 7037	Ral 7042																			
Ral 7016	Ral 9006	Negro/Black/ Noir																			
	 																				
	Lateral Espejo Mirror end panels Joue Miroir																				
	Lateral Display Display end panels Joue Display																				

Serie / Series / Série **MBTP (VANCOUVER)**

+Info: www.infrico.com

MN25 BTP L1



Estantes profundidad 400mm
Shelves 400mm depth
Profondeur des étagères 400mm



**Nuevo
paragolpes
frontal**

**New
front
bumper**

**Nouveau
pare-chocs
frontale**



MN12 BTP L1



MN18 BTP L1

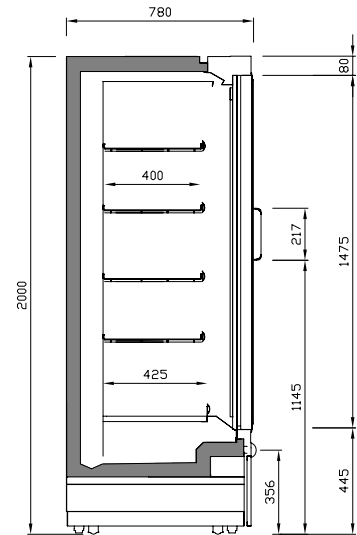

MN BTP L1



Opciones / Options / Options

Colores fuera de carta (epoxi) x mueble / non-standard colours (epoxy) per unit / couleurs hors palette (epoxi) x meuble

Exterior / Exterior / Extérieure	
Interior RAL Infrico Supermarket excepto blanco, negro y gris antracita [7016] / RAL Infrico Supermarket interior except black, white and anthracite grey [7016] / Intérieure RAL Infrico Supermarket sauf noir, blanc et gris anthracite [7016]	

Semimurales grupo incorporado / Plug In low multidecks / Semi murales groupe Incorporé

General General Général	Led cornisa RT Led canopy RT Led corniche RT [carne / meat / viande]	Led estante (línea) Shelf led (line) Led étagère (ligne) 4000k/2700K	Led estante RT carne Shelf led RT meat Led étagère RT viande [línea / line / ligne]	Lateral espejo Mirror end wall Joue miroir	Lateral display Display end wall Joue display	Frente estante metacr. Methacr. shelf front Étagère frontale méthac.
SMS/SML6						
SMS/SML9						
SMS/SML12						
SMS/SML18						
SMS/SML25						

Semimurales grupo remoto / Remote group low multidecks / Semi murales groupe à distance

General General Général	Led cornisa RT Led canopy RT Led corniche RT [carne / meat / viande]	Led estante (línea) Shelf led (line) Led étagère (ligne) 4000k/2700K	Led estante RT carne Shelf led RT meat Led étagère RT viande [línea / line / ligne]
SML12			
SML18			
SML25			
SML37			

General General Général	Lateral espejo Mirror side end Joue miroir	Lateral panorámico Panoramic side end Joue panoramique	Lateral display Display side end Joue display	Frente estante metacrilato Methacrylate shelf front Étagère frontale méthacrylate
SML12				
SML18				
SML25				
SML37				

Murales grupo incorporado / Plug In multidecks / Murales groupe incorporé

General General Général	Lateral espejo Mirror side end Joue miroir	Lateral espejo Inox Mirror side end Inox Joue miroir Inox	Lateral display Display end wall Joue display	Lateral display Inox Display side end Inox Joue display Inox	Separador central espejo Central mirror divider Séparateur central miroir
MS					
MN					
ML					

General General Général	SCC Sist. Condens. Cristal SCC Condens. glass system SCC Syst. condens. vitre	Frente estante metacrilato Methacrylate shelf front Étagère frontale méthacrylate	MS Línea estante 300 MS Shelf line 300 Ligne étagère MS 300	MN/ML Línea estante 400 MN/ML Shelf line 400 Ligne étagère MN/ML 400
MS/MN/ML6				
MS/MN/ML9				
MS/MN/ML12				
MS/MN/ML18				
MS/MN/ML25				

Iluminación Lighting Éclairage	Led cornisa RT Led canopy RT Led corniche RT [carne / meat / viande]	Led estante (línea) Shelf led (line) Led étagère (ligne) 4000k/2700K	Led estante RT carne Shelf led RT meat Led étagère RT viande [línea / line / ligne]	Led vertical 4000K Vertical led 4000K Led vertical 4000K	Led vertical 2700K Vertical led 2700K Led vertical 2700K	Led vertical RT Vertical led RT Led vertical RT [carne / meat / viande]
MS/MN/ML6						
MS/MN/ML9						
MS/MN/ML12						
MS/MN/ML18						
MS/MN/ML25						

+Info: www.infrico.com**Murales grupo remoto / Remote multidecks / Murales groupe remote**

Lateral/Separador Side end/ Divider Joues/Séparateur	Lateral panorámico Panoramic side end Joue panoramique	Lateral Display Display side end Joue Display	Lateral espejo Mirror side end Joue miroir	Separador central Central divider Séparateur central	Separador fijo metacrilato Methacrylate fixed divider Séparateur fixe méthacrylate	
MS						
MN						
MN22						
ML						
ML22						
MX						
MX22						
General General Général	Kit espejo Mirror kit Kit miroir	Línea estante 400 Shelf line 400 Étagère 400	Línea estante 450 Shelf line 450 Ligne étagère 450	Línea estante 500 Shelf line 500 Ligne étagère 500	Línea estante 600 Shelf line 600 Ligne étagère 600	
MS/MN/ML/MX9						
MS/MN/ML/MX12						
MS/MN/ML/MX18						
MS/MN/ML/MX25						
MS/MN/ML/MX31						
MS/MN/ML/MX37						
General General Général	SCC Sist. Condens. Cristal SCC Condens. glass system SCC Syst. condens. vitre	Frente estante metacrilato Methacrylate shelf front Étagère frontale méthacrylate	Ventiladores elect. Electronic fan Ventilateurs élect.	Control elect. Electronic control Control élect.	Termómetro Thermometer Thermomètre	Salida tubos sup. Top tube output Sortie tube sup.
MS/MN/ML/MX9						
MS/MN/ML/MX12						
MS/MN/ML/MX18						
MS/MN/ML/MX25						
MS/MN/ML/MX31						
MS/MN/ML/MX37						
Iluminación Lighting Éclairage	Led cornisa RT Led canopy RT Led corniche RT (carne / meat / viande)	Led estante (línea) Shelf led (line) Led étagère (ligne) 4000k/2700K	Led estante RT carne Shelf led RT meat Led étagère RT viande (línea / line / ligne)	Led vertical 4000K Vertical led 4000K Led vertical 4000K	Led vertical 2700K Vertical led 2700K Led vertical 2700K	Led vertical RT Vertical led RT Led vertical RT (carne / meat / viande)
MS/MN/ML/MX9						
MS/MN/ML/MX12						
MS/MN/ML/MX18						
MS/MN/ML/MX25						
MS/MN/ML/MX31						
MS/MN/ML/MX37						

Murales Congelación grupo incorp. MBTP / Plug In freezer multidecks MBTP / Murales congélation groupe inc. MBTP

Lateral Display Display side end Joue Display	Lateral Opaco Opaque side end Joue opaque	Separador central Central divider Séparateur central	Separador fijo metacrilato Methacrylate fixed divider Séparateur fixe méthacrylate
MNBTP			

Murales Congelación grupo remoto MBT-MBTU / Freezer multidecks MBT-MBTU / Murales congélation groupe à dist. MBT-MBTU

Lateral Opaco Opaque side end Joue Opaque	Lateral Display Display side end Joue Display	Separador fijo metacrilato Methacrylate fixed divider Séparateur fixe méthacrylate	Ventiladores alta efíc. 1 x puerta High efficiency fans 1 x door Ventilateurs haut rendem. 1 x porte	Separador central Central divider Séparateur central	Voltajes especiales Special voltages Tension élect. spéciale
MN					
MN22					
MF					
MF22					

Válvula termostática / Thermostatic valve / Vanne thermostatique

R404a	R410a	R513a	Electrónica Electronic Electronique
R507a	R134a	R449a	

Unidades motocondensadoras Condensing units Motocondensateurs

SIGILUS

Unidades motocondensadoras compactas en construcción silenciosa y motoventilador axial.

Refrigerante R449 A o R134a, o refrigerantes alternativos.

Compresor hermético alternativo, montado sobre amortiguadores, con silenciador de descarga, resistencia de cárter y clixon interno.

Batería condensadora de amplia superficie, de tubos de cobre y aletas de aluminio, con dimensionamiento tropicalizado para temperatura ambiente de hasta 50 °C.

Motoventilador axial de bajas revoluciones.

Control proporcional de presión de condensación mediante variación de velocidad del motoventilador.

Circuito frigorífico equipado con presostatos de alta y baja presión, filtro cerámico, recipiente y visor de líquido.

Air-cooled packaged condensing units in a low-noise axial construction in mechanical, and multiservice versions.

R134a or R449A refrigerant or alternative refrigerants.

Reciprocating hermetic or scroll compressor, acoustically insulated, with discharge muffler, mounted on shock absorbers, with internal klixon and crankcase heater.

Large surface condenser coil, copper pipes and aluminum fins, tropicalised for ambient temperature up to 50 °C.

Low rpm motor fans, mounted on nozzles dynamically balanced propellers and external protection grilles.

Variable speed axial fan for proportional condensation pressure control.

Refrigeration circuit equipped with high and low pressure switches, ceramic filter and sight gauge.

Unité de condensation silencieuse et motoventilateur.

Gaz réfrigérant R449, R134a.

Compresseur hermétique alternatif, monté sur amortisseurs, silencieux de refoulement, résistance de carter et klixon interne.

Batterie de condensation de grande surface d'échange de tubes de cuivre et ailettes en aluminium avec dimensionnement tropicalisé pour température ambiante jusqu'à 50°C.

Motoventilateur à basse vitesse.

Contrôle modulant de la pression de condensation par variation de la vitesse du motoventilateur.

Circuit frigorifique équipé avec pressostats de haute et basse pression, filtre céramique, récipient et viseur de liquide.



Serie / Series / Série SIGILUS / INTARBOX

INTARBOX

Unidades motocondensadoras compactas en construcción horizontal y motoventilador axial o centrífugo.

Refrigerante R449 A o R134a, o refrigerantes alternativos.

Compresor hermético alternativo, montado sobre amortiguadores, con silenciador de descarga y clixon interno.

Batería condensadora de tubos de cobre y aletas de aluminio.

Turbina centrífuga con presión estática disponible para la conducción del aire de condensación (versión centrífuga).

Circuito frigorífico equipado con presostatos de alta y baja presión, filtro cerámico, recipiente y visor de líquido.

Control digital de presión de condensación en versiones -N, y control de condensación todo-nada en versiones -M.

Control proporcional de presión de condensación mediante variación de velocidad del motoventilador (incluido a partir de MDH serie 4 y 5).

Cuadro eléctrico de potencia y maniobra, con protección de compresor y motoventilador.

Air-cooled packaged condensing units with axial or centrifugal fan.

R134a or R449A refrigerant or alternative refrigerants.

Hermetic reciprocating compressor mounted on shock absorbers, with discharge muffler and internal klixon.

High performance condensing coil in copper pipes and aluminium fins.

Centrifugal motor fan with available static pressure for a ducted outlet of condenser hot air (centrifugal version).

Refrigeration circuit equipped with HP and LP switches, filter dryer, liquid receiver and sight gauge.

Digital control of condensing pressure (version N) and on/off control of condensing pressure (version M).

Proportional control of condensing pressure through fan speed variation (version N series 4 and 5).

Full control and power board with compressor and motor fan protection.

Unités moto-condenseurs et motoventilateur centrifuge.

Réfrigérant R449, R134a ou réfrigérants alternatifs.

Compresseur hermétique alternatif, monté sur amortisseurs, silencieux de refoulement et klixon interne.

Batterie de condensation à tubes de cuivre et d'ailettes en aluminium.

Motoventilateur centrifuge avec pression statique disponible pour le gainage de l'air de condensation.

Circuit frigorifique équipé de pressostats d'haute et basse pression filtre céramique, bouteille et voyant de liquide.

Contrôle digital de la pression de condensation en version -N et contrôle de la pression de condensation tout-rien -M.

Contrôle proportionnel de la pression de condensation par variation de vitesse du motoventilateur (à partir de MDH séries 4).

Cadre électrique de puissance et manœuvre avec protection de compresseur et motoventilateur.



Unidades multiservicio con sistema VRC

Multiservice units VRC system

Version multiservice avec système VRC

+Info: www.infrico.com

Estructura

Válvula presostática de aspiración [VP].
 Válvula presostática de by-pass [VC].
 Válvula termostática de inyección de líquido [VE].
 Presostato de control [IP].
 Separador de aceite.

El sistema VRC aplicado a un compresor hermético alternativo adapta el flujo de refrigerante a la demanda de las unidades evaporadoras manteniendo constante la presión en la línea de aspiración.

El sistema VRC se compone de un juego de válvulas de regulación de presión y temperatura capaces de variar de forma progresiva la capacidad frigorífica de un compresor entre un 100% y un 10% de su potencia nominal, a la vez que se reduce la potencia eléctrica absorbida y se protege el compresor al mantener su relación de compresión dentro de los márgenes de seguridad, evitando el riesgo de sobrecalentamiento.

Versión horizontal centrífuga o axial multiservicio Intarbox-multi: series MDH-CV/-V.
 Versión horizontal axial silenciosa multiservicio Siligus-multi: series MDF-V.

Estructure

Suction pressure valve [VP].
 By-pass pressure valve [VC].
 Thermostatic expansion valve for liquid injection [VE].
 Pressure control switch [IP].
 Oil separator.

The VRC system applied to a reciprocating hermetic compressor adjusts the flow of refrigerant to the evaporator unit's demand by maintaining constant pressure in the suction line.

The VRC system is composed of a set of pressure and temperature valves capable of progressive variation of a compressor's cooling capacity between 100% and 10% of this rated power, at the same time the system reduces electrical input power and protects the compressor, maintaining its compression ratio within security margins, eliminating the risk of overheating.
 Intarbox horizontal axial or centrifugal for several services Series MDH-CV/-V.
 Sigilus low-noise axial for several services.

Structure

Vanne pressostatique d'aspiration [VP].
 Vanne pressostatique de by-pass [VC].
 Détendeur thermostatique d'injection de liquide [VE].
 Pressostat de contrôle [IP].
 Séparateur d'huile.

Le système VRC à un seul compresseur hermétique à piston adapte le flux du gaz à la demande des unités d'évaporation, en maintenant de manière constante la pression de la ligne d'aspiration.

Le système VRC est constitué par un ensemble de vannes de régulation de pression et de température qui peuvent varier progressivement la capacité frigorifique du compresseur de 100% jusqu'à 10% de sa puissance nominale, tout en réduisant la puissance électrique absorbée et en protection du compresseur par maintenir son fonctionnement dans les marges de sécurité afin d'éviter le risque de surchauffage.

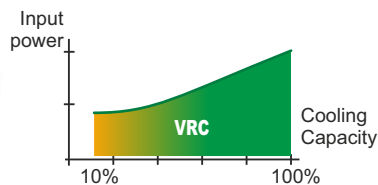
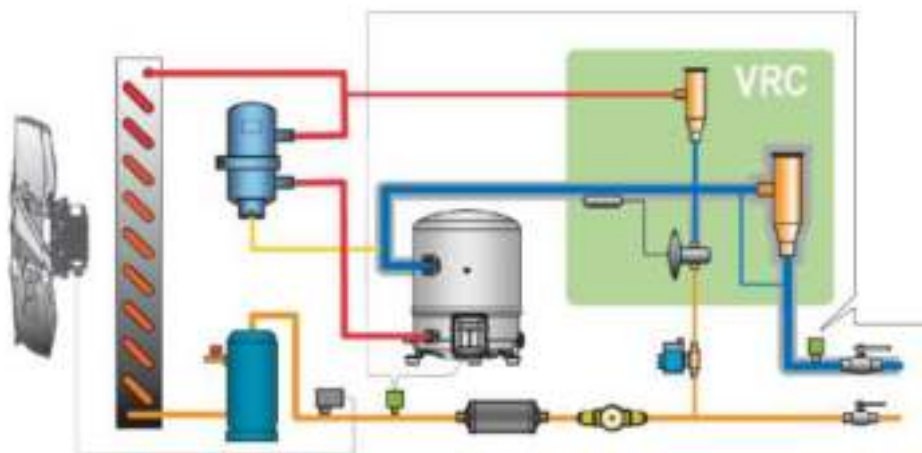

Ejemplo instalación multiservicio

Multiservice installation
 Exemple d'installation multiservice

Los equipos en versión multiservicio están diseñados para centralizar la producción frigorífica de un conjunto de unidades evaporadoras.

Multi-service condensing units are specifically designed for cooling production centralization of a set of positive or negative temperature evaporating units.

Les unités motocondensateurs à système VRC, permettent de centraliser la production frigorifique d'un ensemble de services, en maintenant de manière constante la pression et température du gaz dans les évaporateurs.

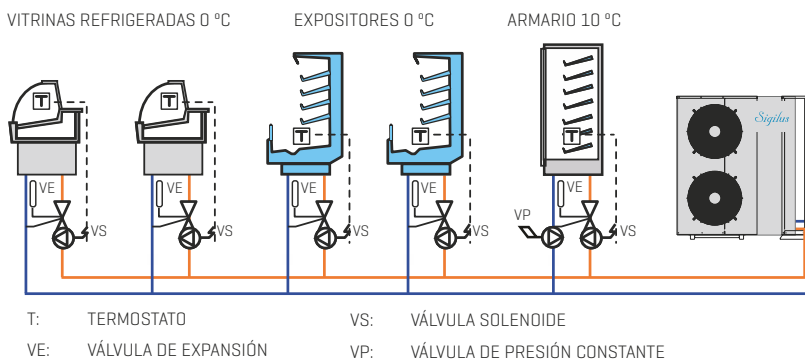

Motocondensadoras

Condensing units

Motocondensateurs

Opciones / Options / Options

Precio
Price (€)
Prix

Cambio a alimentación 400 V-III-50 Hz	
Separador de aceite [ya incluido en versiones -V]	
Válvula solenoide integrada con cuerpo y bobina [sólo en versiones -N y -M]	
Recubrimiento anticorrosión de batería	
Rejilla exterior de protección de batería	
Control de condensación proporcional por variación de velocidad del motoventilador [modelos hasta 1074 con R134a, y modelos hasta 1034 con R449A en MT; y hasta el modelo 1074 en BT]	
Versión electrónica	



230 V-I-50 Hz / 400 V-III-50 Hz | R134a - R449A / R404A | Media temperatura 1 o 2 servicios /

REFRIGERANTE	SERIE / MODELO SERIES / MODEL SÉRIES / MODÈLE		COMPRESOR COMPRESSOR COMPRESSEUR		POTENCIA FRIGORÍF. POWER PUISSANCE FRIGORIF. EN13215 (W) ⁽¹⁾ T° EVAP. -35 °C	POT. FRIGOR./POWER/PUISSANCE FRIGORIF. (W) ⁽²⁾ TEMP. EVAPORAC./EVAPORATION TEMP./TEMP. D'ÉVAPOR.				POTEN.ABSOR. NOMINAL NOMINAL POW. ABSOR. PUISS.ABSORC. NOMINALE (kW)	[C.O.P.] S.E.P.R. ⁽³⁾	INTENS. MÁX. ABSORCIÓN MAX. ABSOR. POWER INTENS. MAX. ABSOR. (A)	VENTILADOR FAN VENTILATEUR Ø mm	CAUDAL FLOW RATE DÉBIT D'AIR (m³/h)	CONEXIÓN FRIGORÍFICA COOLING CONNECTION CONNECTION FRIGORIFIQUE LIQ - GAS	PESO WEIGHT POIDS (kg)	NIVEL PRES. SONORA SOUND PRESS.LEVEL NIVEAU PRESS. SONORE dB(A) ⁽⁴⁾	PVP PRICE PVP (€)
	CV	TENSIÓN	0 °C	-5 °C		-10 °C	-15 °C											
R134a	MDF-MY-0 010	3/8	230 V-I	590	870	700	560	430	0,33	[1,75]	4,0	Ø 200	350	1/4"-3/8"	50	17		
	MDF-MY-0 015	1/2	230 V-I	830	1 200	970	770	610	0,46	[1,73]	5,0	Ø 200	350	1/4"-3/8"	52	22		
	MDF-MY-1 015	1/2	230 V-I	890	1 380	1 100	860	650	0,49	[1,78]	5,0	Ø 360	1 700	1/4"-1/2"	66	22		
	MDF-MY-1 026	3/4	230 V-I	1 370	2 140	1 700	1 310	970	0,71	[1,89]	9,0	Ø 360	1 700	1/4"-1/2"	74	19		
	MDF-MY-1 033	1	230 V-I	1 780	2 680	2 150	1 680	1 250	0,82	[2,10]	9,0	Ø 360	1 700	1/4"-5/8"	76	23		
	MDF-MY-1 053	1 1/2	230 V-I *	2 450	3 900	3 060	2 320	1 720	1,22	[1,96]	12,0	Ø 360	1 700	1/4"-3/4"	88	28		
	MDF-MY-1 074	2	230 V-I *	3 510	5 260	4 200	3 260	2 470	1,60	[2,11]	16,0	Ø 360	1 700	1/4"-3/4"	90	35		
	MDF-MY-2 086	4	400 V-III	4 380	6 670	5 260	4 050	3 030	1,81	[2,32]	13,0	Ø 450	3 600	3/8"-7/8"	98	39		
	MDF-MY-2 108	5	400 V-III	5 370	8 060	6 370	4 900	3 740	2,20	3,25	16,0	Ø 450	3 600	3/8"-7/8"	100	36		
	MDF-MY-2 136	6 1/2	400 V-III	6 850	10 180	8 250	6 500	5 040	2,99	2,89	19,0	Ø 450	3 600	3/8"-1 1/8"	103	35		
R449A	MDF-MG-0 008	1/3	230 V-I	620	980	810	650	510	0,37	[1,72]	4,0	Ø 200	350	1/4"-3/8"	51	20		
	MDF-MG-0 010	3/8	230 V-I	800	1 230	1 020	820	650	0,48	[1,72]	5,0	Ø 200	350	1/4"-3/8"	51	24		
	MDF-MG-0 012	1/2	230 V-I	950	1 420	1 180	960	770	0,56	[1,73]	6,0	Ø 200	350	1/4"-3/8"	51	24		
	MDF-MG-1 014	1/2	230 V-I	1 160	1 920	1 560	1 240	960	0,68	[1,74]	6,0	Ø 360	1 700	1/4"-1/2"	66	25		
	MDF-MG-1 016	5/8	230 V-I	1 320	2 250	1 820	1 440	1 080	0,76	[1,80]	7,0	Ø 360	1 700	1/4"-1/2"	76	25		
	MDF-MG-1 018	3/4	230 V-I	1 650	2 690	2 190	1 750	1 360	0,92	[1,87]	8,0	Ø 360	1 700	1/4"-1/2"	76	25		
	MDF-MG-1 024	1	230 V-I	2 110	3 560	2 890	2 280	1 720	1,06	[2,07]	12,0	Ø 360	1 700	3/8"-5/8"	78	25		
	MDF-MG-1 026	1 1/4	230 V-I *	2 370	3 870	3 160	2 530	1 950	1,18	[2,08]	13,0	Ø 360	1 700	3/8"-5/8"	78	25		
	MDF-MG-1 034	1 1/2	230 V-I *	3 060	4 860	3 980	3 200	2 500	1,66	[1,90]	16,0	Ø 360	1 700	3/8"-5/8"	78	27		
	MDF-MG-1 038	1 3/4	400 V-III	3 360	5 870	4 740	3 720	2 830	1,60	[2,15]	7,0	Ø 450	3 200	3/8"-5/8"	81	30		
	MDF-MG-2 048	2	400 V-III	4 360	6 990	5 670	4 530	3 530	1,98	[2,26]	8,0	Ø 450	3 600	3/8"-3/4"	85	27		
	MDF-MG-2 054	2 1/2	400 V-III	4 840	7 860	6 420	5 160	4 070	2,18	[2,34]	9,0	Ø 450	3 600	3/8"-3/4"	86	27		
	MDF-MG-2 060	3	400 V-III	5 800	8 850	7 290	5 900	4 700	2,59	3,24	10,0	Ø 450	3 600	3/8"-3/4"	87	27		
	MDF-MG-2 068	3 1/2	400 V-III	6 550	9 810	8 150	6 630	5 300	2,97	3,10	10,0	Ø 450	3 600	1/2"-3/4"	88	26		

230 V-I-50 Hz* / 400 V-III-50 Hz | Baja temperatura | Condensadoras Silenciosas | Compresor hermético | R449A

REFRIGERANTE	SERIE / MODELO SERIES / MODEL SÉRIES / MODÈLE		COMPRESOR COMPRESSOR COMPRESSEUR		POTENCIA FRIGORÍF. POWER PUISSANCE FRIGORIF. EN13215 (W) ⁽¹⁾ T° EVAP. -35 °C	POT. FRIGOR./POWER/PUISSANCE FRIGORIF. (W) ⁽²⁾ TEMP. EVAPORAC./EVAPORATION TEMP./TEMP. D'ÉVAPOR.			POTEN.ABSOR. NOMINAL NOMINAL POW. ABSOR. PUISS.ABSORC. NOMINALE (kW)	[C.O.P.] S.E.P.R. ⁽³⁾	INTENS. MÁX. ABSORCIÓN MAX. ABSOR. POWER INTENS. MAX. ABSOR. (A)	VENTILADOR FAN VENTILATEUR Ø mm	CAUDAL FLOW RATE DÉBIT D'AIR (m³/h)	CONEXIÓN FRIGORÍFICA COOLING CONNECTION CONNECTION FRIGORIFIQUE LIQ - GAS	PESO WEIGHT POIDS (kg)	NIVEL PRES. SONORA SOUND PRESS.LEVEL NIVEAU PRESS. SONORE dB(A) ⁽⁴⁾	PVP PRICE PVP (€)
	CV	TENSIÓN	-25 °C	-30 °C		-35 °C											
R449A	BDF-MG-0 018	5/8	230 V-I	370	800	600	420	0,44	[0,96]	6,0	Ø 200	350	1/4"-1/2"	61	17		
	BDF-MG-1 026	3/4	230 V-I	590	1 310	950	670	0,69	[0,96]	9,0	Ø 360	1 700	1/4"-1/2"	67	18		
	BDF-MG-1 034	1 1/4	230 V-I	780	1 720	1 260	880	0,93	[0,95]	10,0	Ø 360	1 700	3/8"-5/8"	83	20		
	BDF-MG-1 055	1 3/4	230 V-I*	990	2 350	1 670	1 114	1,10	[0,97]	16,0	Ø 360	1 700	3/8"-5/8"	93	27		
	BDF-MG-1 075	2 1/2	230 V-I*	1 430	3 050	2 286	1 586	1,50	[1,04]	24,0	Ø 360	1 700	3/8"-5/8"	93	30		
	BDF-MG-2 096	3 1/2	400 V-III	1 800	4 130	2 990	2 020	1,67	[1,18]	11,0	Ø 450	3 600	3/8"-3/4"	98	40		
	BDF-MG-2 108	4	400 V-III	2 240	4 790	3 560	2 470	2,05	1,67	13,0	Ø 450	3 600	3/8"-7/8"	98	38		
	BDF-MG-2 136	5	400 V-III	2 950	5 970	4 490	3 230	2,72	1,60	15,0	Ø 450	3 600	3/8"-7/8"	98	33		
	BDF-MG-3 215	7 1/2	400 V-III	4 500	9 300	6 970	4 940	4,03	1,68	24,0	2x Ø 450	6 500	1/2"-1 1/8"	149	40		
	BDF-MG-3 271	10	400 V-III	6 380	11 960	9 160	6 760	5,36	1,70	28,0	2x Ø 450	6 500	1/2"-1 1/8"	149	40		

Serie / Series / Série **SIGILUS**

+Info: www.infrico.com

Versión multiservicio con sistema VRC
 Multiservice version VRC system
 Version multiservice avec système VRC



COMPRESOR HERMÉTICO R134 a			
R134a	Versión Axial VRC	Potencia Frigorífica	Precio
	Serie / Modelo	(W) T° EVAP. -10 °C	Price (€)
	MDF-VY-2 086	4.150	
	MDF-VY-2 108	5.040	
	MDF-VY-2 136	6.710	
	MDF-VY-3 171	7.440	
	MDF-VY-3 215	9.390	
	MDF-VY-3 271	12.720	

MEDIA TEMPERATURA R449A			
R449A	MDF-VG-1 038	3.540	
	MDF-VG-2 048	4.520	
	MDF-VG-2 054	5.140	
	MDF-VG-2 060	5.880	
	MDF-VG-2 068	6.600	
	MDF-VG-3 086	6.950	
	MDF-VG-3 108	9.200	
	MDF-VG-4 136	11.750	
	MDF-VG-4 160	13.390	

Opciones / Options / Options

Precio
Price (€)
Prix

- Cambio a alimentación 400 V-III-50 Hz
- Separador de aceite [ya incluido en versiones -V]
- Válvula solenoide integrada con cuerpo y bobina [sólo en versiones -N y -M]
- Recubrimiento anticorrosión de batería
- Rejilla exterior de protección de batería
- Control de condensación proporcional por variación de velocidad del motoventilador
- Versión electrónica

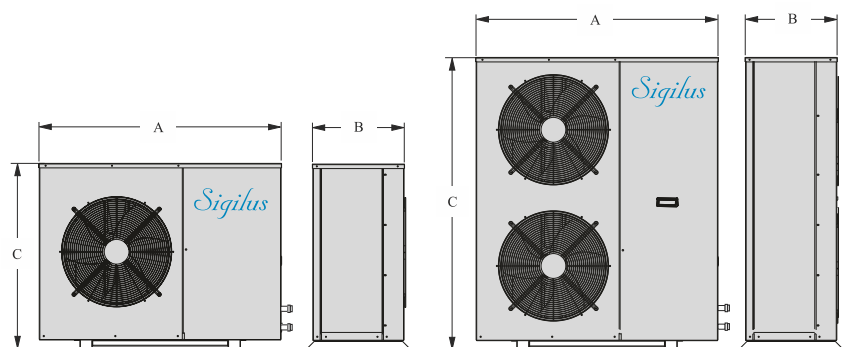

Dimensiones Dimensions Dimensions [mm]	A	B	C
SERIE 0	670	308	440
SERIE 1	1 030	375	580
SERIE 2	1 080	415	830
SERIE 3	1 150	480	1 100
SERIE 4	1 150	480	1 350
SERIE 5	1 480	460	830

Motocondensadoras

Condensing units

Motocondensateurs

Opciones / Options / Options

Cambio a alimentación 400 V-III-50 Hz	
Separador de aceite [ya incluido en versiones -V]	
Resistencia de Cárter	
Válvula solenoide integrada con cuerpo y bobina [sólo en versiones -N y -M]	
Recubrimiento anticorrosión de batería	
Compuerta de descarga antirretorno	
Tolva de adaptación a conducto circular [series 3, 4]	
Control condensación proporcional por variación de velocidad	Axial Centrífuga
Versión electrónica	

Precio
Price (€)
Prix



230 V-I-50 Hz / 400 V-III-50 Hz | R134a - R449A / R404A | Media temperatura

REFRIGERANTE	VERSIÓN AXIAL		POTENCIA FRIGORÍFICA POWER PUISSANCE FRIGORIF. EN13215 (W) T° EVAP. -10 °C	POT. FRIGOR./POWER/PUISSANCE FRIGORIF. (W)				POTEN. ABSOR. NOMINAL POT. ABSOR. PUISS. ABSOR. NOMINALE (kW)	INTENS. MÁX. ABSORCIÓN (C.O.P.) S.E.P.R. (3)	INTENS. MÁX. ABSORCIÓN (A)	CONEXIÓN FRIGORÍFICA COOLING CONNECTION CONNECTION FRIGORIFIQUE LIQ - GAS	PESO WEIGHT POIDS (kg)	NIVEL PRES. SONORA SOUND PRESS.LEVEL NIVEAU PRESS. SONORE dB(A)	PVP PRICE PVP (€)	VERSIÓN CENTRÍFUGA			
	SERIE / MODELO SERIES / MODEL SÉRIES / MODÈLE	CV		TENSIÓN	0 °C	-5 °C	-10 °C								-15 °C	CAUDAL (m³/h)	P.E.D. (3) (mmca)	PVP PRICE PVP (€)
R134a	MDH-MY-0 010	3/8	230 V-I	590	880	710	560	430	0,37	[1,54]	4,0	1/4"-3/8"	37	23	MDH-CMY-0 010	375	8	
	MDH-MY-0 015	1/2	230 V-I	830	1 210	980	780	600	0,51	[1,58]	5,0	1/4"-3/8"	40	30	MDH-CMY-0 015	375	8	
	MDH-MY-1 015	1/2	230 V-I	870	1 290	1 040	820	625	0,50	[1,69]	5,0	1/4"-1/2"	41	30	MDH-CMY-1 015	575	8	
	MDH-MY-1 026	3/4	230 V-I	1 270	1 890	1 520	1 190	920	0,72	[1,72]	9,0	1/4"-1/2"	48	26	MDH-CMY-1 026	575	8	
	MDH-MY-1 033	1	230 V-I	1 630	2 310	1 880	1 500	1 170	0,84	[1,87]	9,0	1/4"-1/2"	50	31	MDH-CMY-1 033	575	8	
	MDH-MY-2 053	1 1/2	230 V-I *	2 250	3 470	2 760	2 120	1 560	1,25	[1,77]	12,0	1/4"-5/8"	63	37	MDH-CMY-2 053	1 000	12	
	MDH-MY-3 074	2	230 V-I *	3 410	5 080	4 080	3 180	2 390	1,61	[2,06]	16,0	1/4"-3/4"	84	44	MDH-CMY-3 074	1 500	14	
	MDH-MY-4 086	4	400 V-III	4 310	6 620	5 240	4 040	3 040	1,97	[2,13]	14,0	3/8"-7/8"	107	48	MDH-CMY-4 086	3 500	10	
	MDH-MY-4 108	5	400 V-III	5 260	7 920	6 350	4 910	3 690	2,39	2,88	17,0	3/8"-7/8"	109	45	MDH-CMY-4 108	3 500	10	
	MDH-MY-4 136	6 1/2	400 V-III	6 700	9 570	7 810	6 210	4 730	3,24	2,59	20,0	3/8"-1 1/8"	112	44	MDH-CMY-4 136	3 500	10	
R449A	MDH-MG-0 008	1/3	230 V-I	620	990	810	650	510	0,42	[1,53]	4,0	1/4"-3/8"	46	28	MDH-CMG-0 008	375	8	
	MDH-MG-0 010	3/8	230 V-I	800	1 250	1 030	830	660	0,52	[1,57]	5,0	1/4"-3/8"	46	33	MDH-CMG-0 010	375	8	
	MDH-MG-0 012	1/2	230 V-I	950	1 435	1 190	980	780	0,60	[1,61]	6,0	1/4"-3/8"	46	33	MDH-CMG-0 012	375	8	
	MDH-MG-1 014	1/2	230 V-I	1 150	1 770	1 460	1 190	950	0,69	[1,69]	6,0	1/4"-1/2"	50	33	MDH-CMG-1 014	575	8	
	MDH-MG-1 016	5/8	230 V-I	1 290	2 020	1 660	1 340	1 040	0,78	[1,71]	7,0	1/4"-1/2"	60	33	MDH-CMG-1 016	575	8	
	MDH-MG-1 018	3/4	230 V-I	1 560	2 360	1 960	1 600	1 270	0,94	[1,72]	8,0	1/4"-1/2"	60	33	MDH-CMG-1 018	575	8	
	MDH-MG-2 024	1	230 V-I	2 070	3 270	2 680	2 150	1 680	1,10	[1,93]	12,0	3/8"-5/8"	60	33	MDH-CMG-2 024	1 000	12	
	MDH-MG-2 026	1 1/4	230 V-I *	2 300	3 550	2 930	2 370	1 870	1,24	[1,91]	13,0	3/8"-5/8"	61	34	MDH-CMG-2 026	1 000	12	
	MDH-MG-2 034	1 1/2	230 V-I *	2 870	4 300	3 590	2 920	2 310	1,73	[1,71]	16,0	3/8"-5/8"	61	36	MDH-CMG-2 034	1 000	12	
	MDH-MG-3 038	1 3/4	400 V-III	3 270	4 970	4 100	3 310	2 610	1,56	[2,12]	6,0	3/8"-5/8"	78	39	MDH-CMG-3 038	1 500	14	
MDH-MG-4 048	2	400 V-III	4 330	6 850	5 580	4 460	3 490	2,14	[2,08]	13,0	3/8"-3/4"	95	36	MDH-CMG-4 048	3 500	10		
MDH-MG-4 054	2 1/2	400 V-III	4 970	7 660	6 300	5 070	4 010	2,38	[2,14]	14,0	3/8"-3/4"	96	36	MDH-CMG-4 054	3 500	10		
MDH-MG-4 060	3	400 V-III	5 720	8 590	7 130	5 800	4 620	2,84	2,98	15,0	3/8"-3/4"	97	35	MDH-CMG-4 060	3 500	10		
MDH-MG-4 068	3 1/2	400 V-III	6 450	9 490	7 920	6 500	5 210	3,26	2,87	15,0	1/2"-3/4"	98	35	MDH-CMG-4 068	3 500	10		

230 V-I-50 Hz* / 400 V-III-50 Hz | Baja temperatura | Compresor hermético | R449A

REFRIGERANTE	VERSIÓN AXIAL		POTENCIA FRIGORÍFICA POWER PUISSANCE FRIGORIF. EN13215 (W) T° EVAP. -35 °C	POT. FRIGOR./POWER/PUISSANCE FRIGORIF. (W)			POTEN. ABSOR. NOMINAL POT. ABSOR. PUISS. ABSOR. NOMINALE (kW)	INTENS. MÁX. ABSORCIÓN (C.O.P.) S.E.P.R. (3)	INTENS. MÁX. ABSORCIÓN (A)	CONEXIÓN FRIGORÍFICA COOLING CONNECTION CONNECTION FRIGORIFIQUE LIQ - GAS	PESO WEIGHT POIDS (kg)	NIVEL PRES. SONORA SOUND PRESS.LEVEL NIVEAU PRESS. SONORE dB(A)	PVP PRICE PVP (€)	VERSIÓN CENTRÍFUGA			
	SERIE / MODELO SERIES / MODEL SÉRIES / MODÈLE	CV		TENSIÓN	-25 °C	-30 °C								-35 °C	CAUDAL (m³/h)	P.E.D. (3) (mmca)	PVP PRICE PVP (€)
R449A	BDH-MG-1 026	3/4	230 V-I	590	1 220	930	670	0,69	[0,96]	9,0	1/4"-1/2"	51	28	BDH-CMG-1 026	575	8	
	BDH-MG-1 034	1 1/4	230 V-I	780	1 520	1 170	860	0,92	[0,95]	10,0	1/4"-1/2"	52	32	BDH-CMG-1 034	575	8	
	BDH-MG-2 055	1 3/4	230 V-I	980	2 195	1 630	1 110	1,20	[0,95]	16,0	3/8"-5/8"	69	37	BDH-CMG-2 055	1 000	12	
	BDH-MG-2 075	2 1/2	230 V-I	1 400	2 785	2 130	1 560	1,50	[1,02]	24,0	3/8"-5/8"	69	40	BDH-CMG-2 075	1 000	12	
	BDH-MG-3 096	3 1/2	400 V-III	2 080	3 663	2 733	1 940	1,69	[1,15]	11	3/8"-3/4"	88	49	BDH-CMG-3 096	1 500	14	
	BDH-MG-4 108	4	400 V-III	2 240	4 690	3 500	2 470	2,15	1,62	14,0	3/8"-7/8"	117	43	BDH-CMG-4 108	3 500	10	
	BDH-MG-5 136	5	400 V-III	2 950	6 080	4 560	3 230	2,83	1,61	16,0	1/2"-1 1/8"	152	32	BDH-CMG-5 136	3 600	10	
	BDH-MG-5 215	7 1/2	400 V-III	4 500	8 870	6 670	4 820	4,07	1,60	24,0	1/2"-1 1/8"	183	43	BDH-CMG-5 215	3 600	10	

Serie / Series / Série **INTARBOX**

+Info: www.infrico.com

Versión multiservicio con sistema VRC
 Multiservice version VRC system
 Version multiservice avec système VRC



MEDIA TEMPERATURA - COMPRESOR HERMÉTICO			
Versión Axial VRC	Serie / Modelo	Potencia Frigorífica	Precio Price (€)
		(W) T° EVAP. -10 °C	
R134a	MDH-VY-4 086	4.020	
	MDH-VY-4 108	4.870	
	MDH-VY-4 136	6.500	
	MDH-VY-5 171	7.560	
	MDH-VY-5 215	9.310	
	MDH-VY-5 271	12.600	
	MEDIA TEMPERATURA R449A		
R449A	MDH-VG-3 038	3.270	
	MDH-VG-4 048	4.420	
	MDH-VG-4 054	5.030	
	MDH-VG-4 060	5.740	
	MDH-VG-4 068	6.410	
	MDH-VG-5 086	7.270	
	MDH-VG-5 108	9.290	

MEDIA TEMPERATURA - COMPRESOR HERMÉTICO		
Versión Centrífuga	Serie / Modelo	Precio Price (€)
		MDH-CVY-4086
MDH-CVY-4108		
MDH-CVY-4136		
MDH-CVY-5171		
MDH-CVY-5215		
MDH-CVY-5271		
MEDIA TEMPERATURA R449A		
MDH-CVG-3038		
MDH-CVG-4048		
MDH-CVG-4054		
MDH-CVG-4060		
MDH-CVG-4068		
MDH-CVG-5086		
MDH-CVG-5108		

Dimensiones DH-Axial / Dimensions DH-Axial

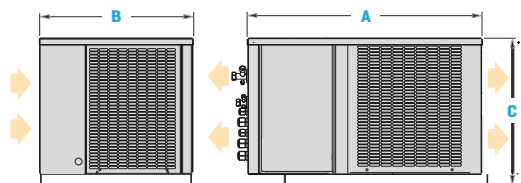

Dimensiones (mm)	A	B	C
SERIE 0	600	395	355
SERIE 1	665	435	416
SERIE 2	835	435	500
SERIE 3	925	580	515
SERIE 4	1000	615	585
SERIE 5	1290	755	656

Dimensiones DH-centrífuga / Dimensions dh-centrífugal

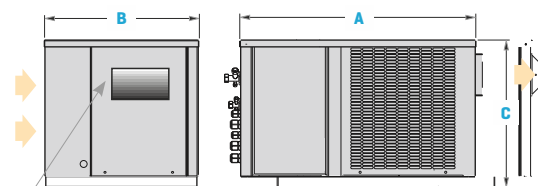

Dimensiones (mm)	A	B	C	Embocadura turbina
SERIE 0	600	395	355	185X115
SERIE 1	665	435	416	185X115
SERIE 2	835	435	500	230X130
SERIE 3	925	580	515	236X266
SERIE 4	1000	615	585	305X266
SERIE 5	1290	755	656	305X266

EMBOCADURA TURBINA (VERSION CENTRÍFUGA)

Opciones Options	Precio Price (€)
Cambio a alimentación 400 V-III-50 Hz	
Separador de aceite [ya incluido en versiones -V]	
Resistencia de Cáster	
Válvula solenoide integrada con cuerpo y bobina [sólo en versiones -N y -M]	
Recubrimiento anticorrosión de batería	
Compuerta de descarga antirretorno	
Tolva de adaptación a conducto circular [series 3, 4]	
Control condensación proporcional por variación de velocidad	Axial: Centrífuga:
Versión electrónica	

Sist. de refrig. para supermercados con condensación en circuito de agua con carga reducida

Supermarket refriger. syst. with indirect condensation by water circuit with reduced load

Syst. de réfrig. pour supermarchés à condensation avec circuit d'eau et charge réduite

Grupos condensados por agua

Descripción:

Grupos frigoríficos condensados por agua para refrigeración a temperatura positiva, de tamaño muy compacto y silencioso, diseñados para instalación en pared, suelo o sobre el servicio frigorífico.

Características:

Carrocería en chapa de acero galvanizado prelacado, con revestimiento fonoabsorbente, con registro frontal desmontable para acceso a compresor y cuadro eléctrico.

Inyección de líquido en modelos de baja temperatura con R 449 A

- Alimentación 400 V-III-50 Hz.
- Compresor scroll sobre soportes antivibratorios con aislamiento acústico.
- Condensador de placas soldadas de acero inoxidable.

Circuito frigorífico con recipiente, filtro, visor, válvula solenoide, presostatos de AP y BP y válvulas de servicio.

· Circuito hidráulico de condensación en tubo de cobre con conexiones roscadas.

· Cuadro eléctrico de control con protección diferencial y magnetotérmica.

Aeroenfriadores con grupo hidráulico

Descripción:

Aeroenfriadores de agua con grupo hidráulico, en construcción silenciosa, diseñados para la evacuación del calor del bucle de agua de condensación de equipos frigoríficos.

Características:

Motoventiladores axiales silenciosos de bajas revoluciones, montados en tobera, hélices equilibradas dinámicamente y rejillas de protección exterior.

· Batería de agua de alta eficiencia de tubos de cobre y aletas de aluminio.

· Grupo hidráulico incorporado formado por bomba circuladora electrónica con caudal variable, vaso de expansión, válvula de seguridad, filtro de malla, termomanómetros y toma de llenado/vaciado.

· Conexiones hidráulicas a roscar.

· Cuadro eléctrico de potencia, con protección de bomba hidráulica y motoventilador, y regulador de velocidad.

Water condensing units

Description:

Air-coolers with condensation by cooling water at positive temperature. very compact size and quiet, designed for wall, floor or above refrigeration services.

Characteristics:

Casing in prepainted galvanized steel sheet, with sound-absorbing insulation with removable front panel for access to the compressor and the electrical panel liquid injection in low temperature model with R-449 A.

- Power supply 400 V-III-50 Hz.
- Scroll compressor with sound insulation packet.
- Refrigeration circuit with stainless steel brazed plates heat exchanger.
- Ceramic drier filter, sight gauge for HP and LP solenoid valves.
- Hydraulic condensation circuit made of copper pipe with threaded connections.
- Electrical control panel with differential thermomagnetic protection.

Drycooler with built-in hydraulic group

Description:

Drycoolers with built-in hydraulic group, in a low-noise construction, designed for heat dissipation of the refrigeration equipment condensation water loop.

Characteristics:

Low speed axial fans, with dynamically balanced blades, supported by air nozzle and external protection grilles.

· High efficiency water coils with copper pipes and aluminum fins. Hydraulic group with variable flow electronic pump, expansion valve, safety valve, filter, thermomanometers and auto-fill valve included.

· Threaded hydraulic connections.

· Electric power panel, with protection of hydraulic pump and fan motor

Groupes condensés à eau

Description:

Groupes frigorifiques condensés à eau pour la réfrigération à température positive, de dimensions très compactes et silencieux, conçus pour installation murale, sol ou sur le mobilier frigorifique.

Caractéristiques:

Carrosserie en tôle d'acier galvanisée prélaquée, avec revêtement phonoabsorbant, avec registre frontal démontable pour l'accès au compresseur et tableau électrique.

Alimentation électrique 400V-III-50Hz.

Compresseur hermétique scroll sur des supports antivibratoires avec isolation acoustique.

Précharge de gaz R134a.

Condenseur à plaques brasées d'acier inoxydable. Circuit frigorifique avec bouteille de liquide, filtre, voyant de liquide, vanne solénoïde, pressostats HP et BP et vannes de service.

Circuit hydraulique de condensation en tube de cuivre avec des raccords filetés.

Tableau électrique de contrôle avec protection différentiel y magnétothermique.

Aérefroidisseurs avec groupe hydraulique

Description:

Les aérefroidisseurs d'eau avec groupe hydraulique, en construction silencieux, conçus pour l'évacuation de la chaleur de la boucle d'eau de condensation des équipements frigorifiques.

Caractéristiques:

Motoventilateurs axiaux silencieux de basse vitesse, montés en buse, hélices équilibrés dynamiquement et grilles de protection extérieure.

Batterie de refroidissement d'eau d'haute efficacité en tubes de cuivre et ailettes d'aluminium.

Groupe hydraulique incorporé composé d'une pompe électronique de circulation d'eau à débit variable, valve d'expansion, vanne de sécurité, filtre à tamis, thermomanomètre et prise de remplissage.

Connexions hydrauliques sur tableau électrique de puissance, avec protection de la pompe hydraulique et des motoventilateurs.

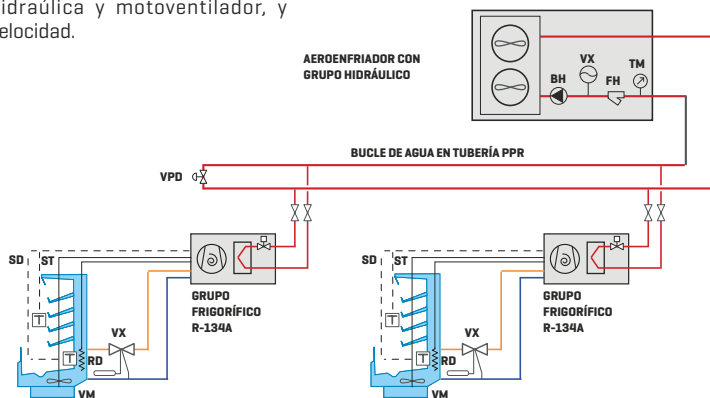

VPD: válvula de presión diferencial / differential pressure valve / Vanne de pression différentielle

ST: sonda termostato / thermostat probe / Sonde thermostatique

SD: sonda desescarche / defrost probe / Sonde de dégivrage

VX: válvula de expansión / expansion valve / Détendeur thermostatique

VM: motoventilador / motor fan / Motoventilateur

RD: resistencia de desescarche / defrost heater / Résistance de dégivrage

BH: bomba hidráulica / hydraulic pump / Pompe hydraulique

FH: filtro hidráulico de malla / hydraulic mesh filter / Filtre hydraulique à tamis

TM: termomanómetro / thermomanometer / Thermomanomètre

VX: vaso de expansión / buffer tank / Vanne d'expansion

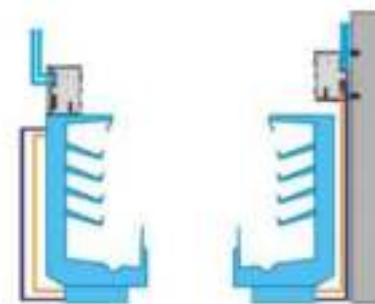

Serie / Series / Série **WATERLOOP**

+Info: www.infrico.com

Grupos condensados por agua / Water condensing units / Unités de condensation à eau



Opcional / Optional / Option
Carga de refrigerante para 5 metros de tubería
 Refrigerant charge for 5 meters of pipe
 Charge de réfrigérant pour 5 metres de tube

400 V-III-50 Hz | R134a - R449A / R404A | Media temperatura - Compresor scroll

Refrigerante	Compresor	Compresor			Potencia frigorífica [W] ⁽¹⁾			Potencia absorb. nominal [kW]	Intens. máx. absorb. [A]	Caudal de agua [l/h]	Conexiones hidráulicas	Pérdida de carga [MCA]	Conexión frigorífica Liq-Gas	Peso [kg]	S.P.L. N.P.A. dB(A) ^(e)	PVP [€]	
		Serie / Modelo	CV	Modelo	Tensión	Temperatura de evaporación											
						0 °C	-5 °C										-10 °C
R134a	1x Scroll	MDM-SMY-1 009	1 1/4	ZS09	400 V-III *	1 840	1 540	1 270	0,7	3	350	3/4"	0,5	1/4"-5/8"	34	40	
		MDM-SMY-1 015	2	ZB15	400 V-III *	2 810	2 350	1 940	1,1	5	500	3/4"	0,5	1/4"-5/8"	43	37	
		MDM-SMY-1 021	3	ZB21	400 V-III *	4 200	3 500	2 890	1,5	7	750	3/4"	0,5	1/4"-3/4"	53	40	
		MDM-SMY-1 029	4	ZB29	400 V-III	5 200	4 340	3 590	2,0	10	1 000	1"	0,5	3/8"-7/8"	53	40	
		MDM-SMY-1 038	5	ZB38	400 V-III	7 060	5 890	4 860	2,5	13	1 250	1"	0,5	3/8"-7/8"	68	53	
		MDM-SMY-1 045	6	ZB45	400 V-III	8 250	6 890	5 700	2,9	13	1 500	1"	0,5	3/8"-1 1/8"	70	43	
		MDM-SMY-1 057	8	ZB57	400 V-III	10 500	8 760	7 240	4,1	16	2 000	1 1/4"	0,5	1/2"-1 1/8"	75	50	
R449A	1x Scroll	MDM-SMG-1 009	1 1/4	ZS09	400 V-III *	2 790	2 250	1 840	1,2	2	500	1"	0,5	1/4"-5/8"	34	40	
		MDM-SMG-1 015	2	ZB15	400 V-III *	4 320	3 640	3 050	1,7	5	750	1"	0,5	3/8"-5/8"	43	37	
		MDM-SMG-1 021	3	ZB21	400 V-III *	6 330	5 340	4 460	2,4	7	1 250	1"	0,5	3/8"-7/8"	53	40	
		MDM-SMG-1 029	4	ZB29	400 V-III	7 787	6 580	5 510	3,1	10	1 500	1 1/4"	0,5	1/2"-7/8"	53	40	
		MDM-SMG-1 038	5	ZB38	400 V-III	10 500	8 870	7 430	3,9	13	2 000	1 1/4"	0,5	1/2"-7/8"	68	53	
		MDM-SMG-1 045	6	ZB45	400 V-III	13 100	11 200	9 420	5,6	13	2 500	1 1/4"	0,5	1/2"-1 1/8"	70	43	

400 V-III-50 Hz | R449A / R404A | Baja temperatura - Compresor scroll

Refrigerante	Compresor	Compresor			Potencia frigorífica [W] ⁽¹⁾				Potencia absorb. nominal [kW]	Intens. máx. absorb. [A]	Caudal de agua [l/h]	Conexiones hidráulicas	Pérdida de carga [MCA]	Conexión frigorífica Liq-Gas	Peso [kg]	S.P.L. N.P.A. dB(A) ^(e)	PVP [€]	
		Serie / Modelo	CV	Modelo	Tensión	Temperatura de evaporación												
						-20 °C	-25 °C	-30 °C										-35 °C
R449A	1x Scroll	BDM-SMG-1 006	2	ZF06	400 V-III *	2 240	1 840	1 500	1 210	1,6	5	600	3/4"	0,5	1/4"-5/8"	45	39	
		BDM-SMG-1 009	3	ZF09	400 V-III	3 120	2 560	2 080	1 660	2,0	6	750	3/4"	0,5	3/8"-3/4"	54	44	
		BDM-SMG-1 011	3 1/2	ZF11	400 V-III	3 843	3 180	2 580	2 070	2,4	8	850	3/4"	0,5	3/8"-3/4"	55	45	
		BDM-SMG-2 013	4	ZF13	400 V-III	4 320	3 560	2 900	2 340	2,7	9	1 000	1"	0,5	3/8"-7/8"	55	47	
		BDM-SMG-2 015	5	ZF15	400 V-III	5 400	4 440	3 600	2 890	3,5	10	1 250	1"	0,5	3/8"-7/8"	73	47	
		BDM-SMG-2 018	6	ZF18	400 V-III	6 460	5 300	4 300	3 450	4,1	14	1 500	1"	0,5	3/8"-1 1/8"	78	47	
		BDM-SMG-2 025	8	ZF25	400 V-III	8 060	6 640	5 390	4 330	4,5	16	2 000	1 1/4"	0,5	3/8"-1 1/8"	78	47	

Waterloop aeroenfriadores con grupo hidráulico / Drycooler with built-in hydraulic group / Refroidisseurs à air avec groupe hydraulique

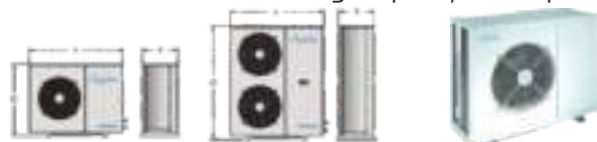

230-I-50 Hz | Water / Eau | Media temperatura /

Series / Modelo	Tensión	Potencia térmica de intercambio [W] ⁽¹⁾	Caudal de aire [m³/h]	Ventilador Ø mm	Caudal de agua [l/h]	Potencia absorb. nominal [kW]	Intens. máx. absorb. [A]	Presión disponible [kPa]	Conexiones hidráulicas	Peso [kg]	S.P.L. dB(A) ^(e)	PVP [€]
CWF-0	230 V-I	3 000	1 700	1x Ø360	500	0,14	1,1	100	3/4"	76	30	
CWF-1	230 V-I	4 700	3 200	1x Ø450	750	0,22	1,8	100	3/4"	79	26	
CWF-2	230 V-I	6 000	3 700	1x Ø450	1 000	0,24	2,0	100	1"	81	26	
CWF-3	230 V-I	10 000	6 500	2x Ø450	1 500	0,44	3,6	100	1"	1014	29	
CWF-4	230 V-I	12 000	7 000	2x Ø450	2 000	0,48	3,9	100	1 1/4"	113	29	
CWF-6	230 V-I	20 000	13 000	4x Ø450	3 000	0,88	7,0	100	1 1/2"	160	32	
CWF-8	230 V-I	24 000	14 000	4x Ø450	4 000	0,96	7,5	100	1 1/2"	185	32	

Los datos técnicos están sujetos a posibles variaciones que serán actualizadas periódicamente en las fichas técnicas del producto, disponibles en la web / The technical data are subject to possible variations that will be updated periodically in the technical data sheets of the product, which are available on the website / Les données techniques peuvent varier et seront actualisées dans les fiches techniques du produit, disponibles sur le site web.

Centrales frigoríficas Refrigeration units Centrales frigorífiques

INTARCUBE CENTRÍFUGA

Motocondensadoras y centrales de refrigeración compactas, de uno a tres compresores, con condensación centrífuga, para media y baja temperatura, incorporan cuadro eléctrico y regulación electrónica [según versión] con control de condensación.

Self-contained air-cooled refrigeration centrals, from 1 to 3 compressors, for positive and negative temperature applications, featuring control board and electronic regulation [depending on the version] with control of condensing temperature.

Motocondensateurs et installations frigorifiques compactes, de un à trois compresseurs, avec condensation centrifuge, pour moyenne et basse température, avec panneau électrique et régulation électronique [selon la version], avec contrôle de la condensation.

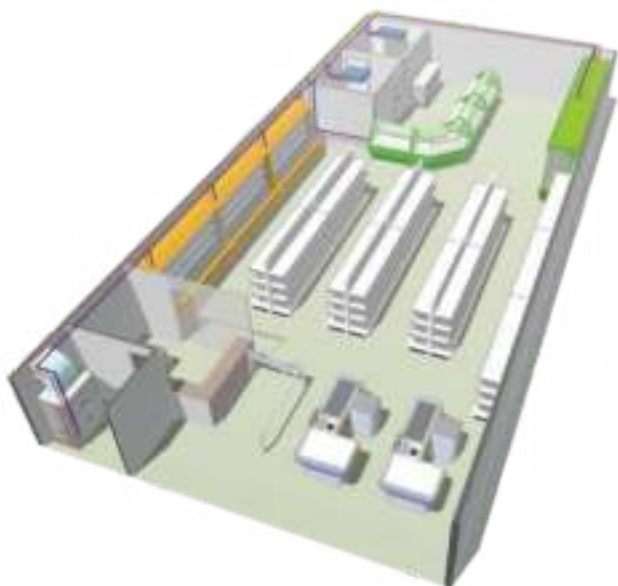

Serie / Series / Série **INTARCUBE**+Info: www.infrico.com**INTARCUBE AXIAL**

La central de refrigeración axial intarCUBE ha sido diseñada para su instalación en intemperie capaz de funcionar bajo condiciones ambientales extremas, pudiendo dar servicio a varias unidades evaporadoras. Incorpora turbinas axiales y componentes aislados para proporcionar los más bajos niveles de ruido.

Axial air-condensed chillers are designed for outdoors installations, able to operate under extreme ambient conditions, to service several evaporating units and other applications at positive and/or several evaporating units and other applications at positive and/or negative temperature, like multiservice installations, or refrigeration installations with up to 4 power steps. Thanks to axial fans and insulating components, these units are able to provide the lowest sound levels.

Le groupe de refroidissement axial intarCUBE a été conçu pour leur installation extérieure, capable de fonctionner sous conditions environnementales extrêmes, il peut servir plusieurs unités d'évaporation. Il intègre des turbines axiales et des composants isolés pour garantir les niveaux de bruit les plus faibles.

Unidades motocondensadoras silenciosas / Low noise condensing units / Unités motocondensateurs silencieuses

Cuadro eléctrico integrado con protección diferencial (según modelo) y magnetotérmica
Integrated electrical panel with differential protection (depending on model and circuit breaker)
Tableau électrique intégré avec protection différentielle (selon le modèle), et magnétothermique

Manómetros de AP y BP (serie 6, 7 y 8)
AP and BP pressure gauge (series 6, 7 and 8)
Monomètre de AP et BP (série 6, 7 et 8)

Conexiones frigoríficas en el lateral izquierdo
Refrigerator connections on the left side
Connexions frigorifiques sur le côté gauche



Ventiladores axiales
Axial fans
Ventilateurs axiaux

Regulación electrónica de última generación [según versión]
Last generation electronic regulation (depending on version)
Contrôle électronique de dernière génération

Batería condensadora tropicalizada con separación del flujo del aire
Tropicalized condensing battery with airflow separation
Batterie condensatrice tropicalisée avec séparation de flux d'air

Compresores con aislamiento acústico
Compressors with sound insulation
Compresseurs avec isolement acoustique

11. Vitrinas Pastelería

Pastry Display Cases / Vitrines Pâtisseries et Glace





 Infrico

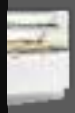

11. Vitrinas Pastelería

Pastry Display Cases / Vitrines Pâtisseries et Glace





COFFEE

2.5

LATTE

3.5

MOCHA

3.5

Infraco

Infraco

HAVE A NICE DAY

11. Vitrinas Pastelería

Pastry Display Cases / Vitrines Pâtisseries et Glace

Flexibilidad de implantación que te permiten combinar los diferentes tipos de venta dentro de un mismo lineal.

Flexibility of implementation that allows you to combine different types of sales on the same line.

Flexibilité de mise en œuvre qui permet de combiner différents types de ventes sur une même ligne.



Decoración con colores personalizables.

Decoration with customisable colours.

Décoration avec des couleurs personnalisables.

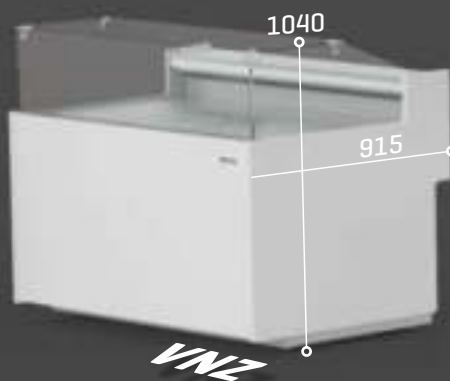
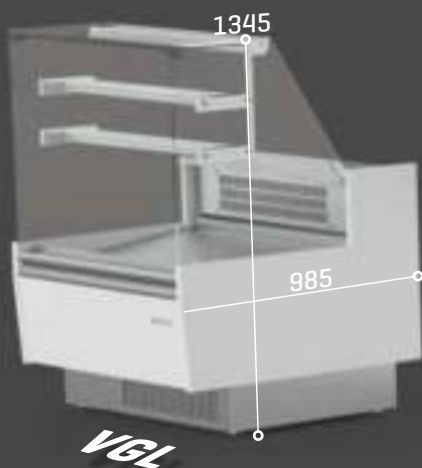

Testada en condiciones ambientales exigentes para ofrecer las mejores prestaciones en todas las condiciones ambientales.

Tested under demanding environmental conditions to provide the best performance in all environmental conditions.

Flexibilité de mise en œuvre qui permet de combiner différents types de ventes sur une même ligne.



+Info: www.infrico.com

Exposición de productos refrigerados, productos calientes y para temperatura ambiente.

Display of refrigerated products, hot products and products for ambient temperatures.

Exposition de produits réfrigérés, de produits chauds et de produits à température ambiante.

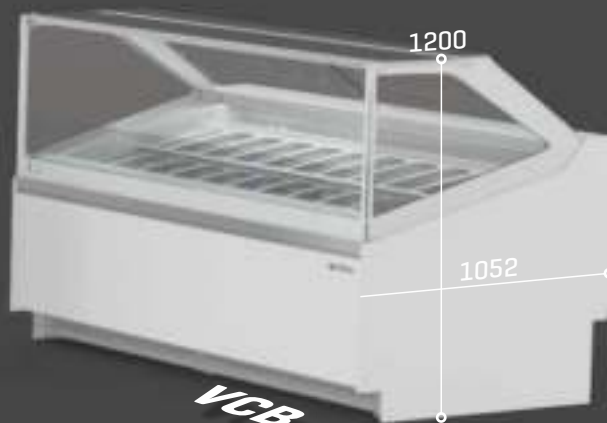
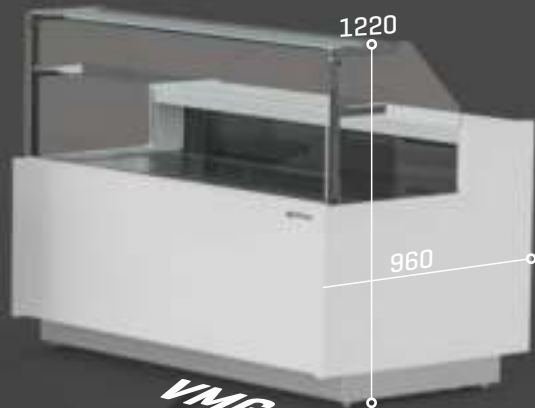
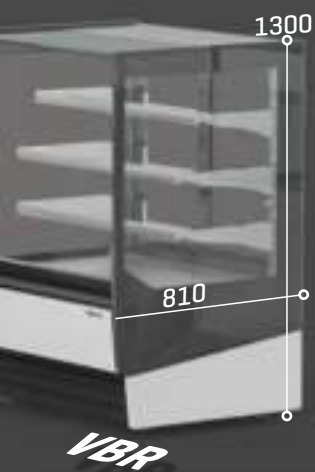

En la Ambar y VON: dos diseños diferentes, con cristal recto y curvo, para integrar dentro de todas las áreas de venta.

In the Ambar and VON: two different designs, with straight and curved glass, for integration into all sales areas.

Ambar et VON : deux modèles différents, avec verre droit et verre bombé, pour une intégration dans tous les espaces de vente.



11. Vitrinas Pastelería

Pastry Display Cases / Vitrines Pâtisseries et Glace

Serie / Series / Série

GLACE

Vitrina expositora con reserva para pastelería

448 - 453

Pastry display case with storage

Vitrine d'exposition pour pâtisserie avec réserve réfrigérée

Serie / Series / Série

NIZA

Vitrina expositora para pastelería

454 - 457

Pastry display case

Vitrine d'exposition pour pâtisserie

Serie / Series / Série

LYON

Vitrina expositora para pastelería

458 - 465

Pastry display case

Vitrine d'exposition pour pâtisserie

Serie / Series / Série

ÁMBAR

Vitrina expositora para pastelería

466 - 469

Pastry display case

Vitrine d'exposition pour pâtisserie

+Info: www.infrico.com

Serie / Series / Série

**VGL
GLACE**



Serie / Series / Série

**VNZ
NIZA**

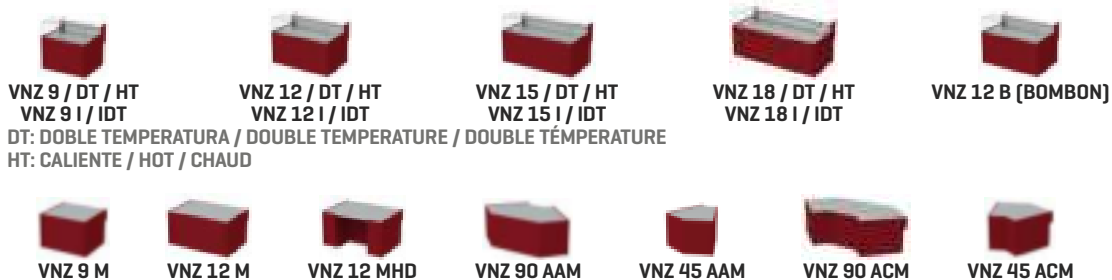

Serie / Series / Série

**VLY
LYON**



Serie / Series / Série

**VBR
ÁMBAR**

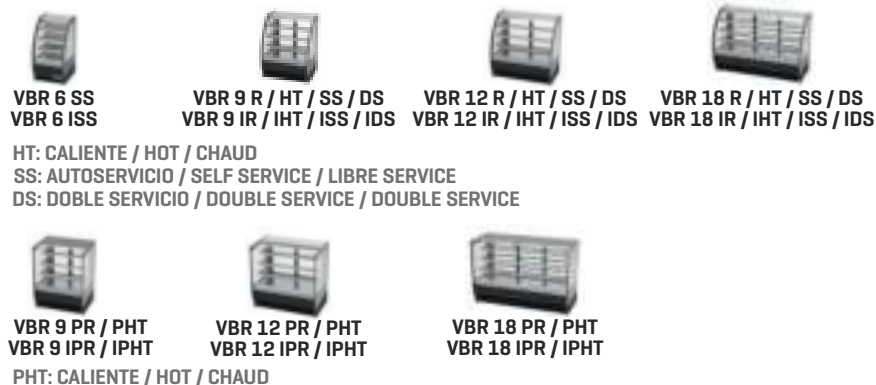

11. Vitrinas Pastelería

Pastry display cases / Vitrines pâtisseries et glace

Serie / Series / Série

ONIX**Vitrina expositora para pastelería**

Pastry display case

Vitrine d'exposition pour pâtisserie

470 - 473

Serie / Series / Série

COMBO**Vitrina expositora para pastelería y panadería**

Pastry display case

Vitrine d'exposition pour cafétéria et pâtisserie

474 - 475

Serie / Series / Série

MAGNUS**Vitrina expositora modular para pastelería y panadería**

Modular pastry display case

Vitrine d'exposition pour cafétéria et pâtisserie

476 - 485

Serie / Series / Série

CORAL**Vitrina expositora helados**

Ice-cream display case

Vitrine d'exposition pour glace

486 - 487

Serie / Series / Série

ARIES**Vitrina expositora helados**

Ice-cream display case

Vitrine d'exposition pour glace

488 - 489

Serie / Series / Série

IBIZA**Vitrina expositora helados frío estático**

Ice-cream static display case

Vitrine d'exposition statique pour glace

490 - 491

+Info: www.infrico.com

Serie / Series / Série

**VON
ONIX**

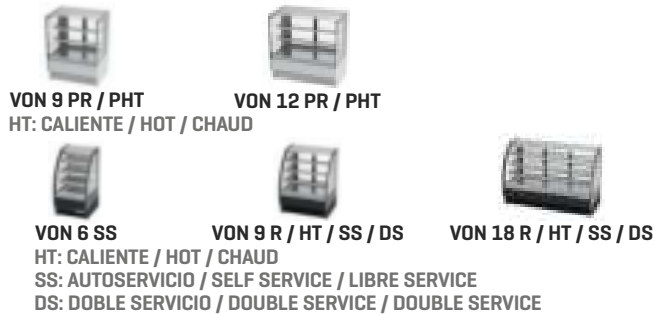

Serie / Series / Série

**VCO
COMBO**



Serie / Series / Série

**VMG
MAGNUS**



Serie / Series / Série

NEW
**VCB
CORAL**



Serie / Series / Série

**VAR
ARIES**





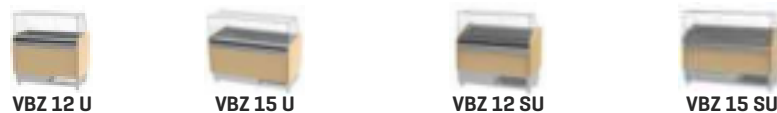

Serie / Series / Série

**VBZ
IBIZA**



Vitrina expositora con reserva para pastelería / Pastry display case with storage / Vitrine d'exposition pour pâtisserie avec réserve réfrigérée

MODELO MODELE MODÈLE					
Precio Price Prix					
	NEUTRO / NEUTRAL / NEUTRE				
MOD.	VGL 9 CN	VGL 12 CN	VGL 15 CN	VGL 18 CN	VGL 25 CN
Precio Price Prix					
Medidas Measures Mesures (mm)	998 x 985 x 1345 mm.	1310 x 985 x 1345 mm.	1622 x 985 x 1345 mm.	1935 x 985 x 1345 mm.	2560 x 985 x 1345 mm.
Temperatura Temperature Température (°C)	4°C/+8°C				
Clase Climática Climatic class Classe climatique (°C)	3 / 25°C				
Tensión/Frecuencia Electrical data Tension électrique	230V/1ph/50Hz				
Controlador Controller Régulateur	Digital				
Material Material Matériel [EXT/INT]	Madera lacada / Lacquered wood / Bois laqué Plano exposición / Exhibition plan / Plan d'exposition: Inox Aisi 304				
Aislamiento Isolation Isolation (mm)	40kg/m ³ / Free CFC's / Zero ODP-GWP				
Capacidad Capacity Capacité (L)	163	216	271	327	430
Superficie exposición Surface exhibition Surface d'exposition (m ²)	0,9	1,2	1,5	1,8	2,5
Compresor Compressor Compresseur (HP)	-				
Estantes Shelving Étagères	2				
Costados [2] Sides [2] Joues [2] (mm)	30+30				
Sistema de frío Cooling System Système de froid	Ventilado / Ventilated / Ventilé				
Desescarche Defrost Dégivrage	Manual / Manual / Manuel				
Evaporación Evaporation Évaporation	Semiestática / Semistatic / Semiestatique				
Potencia Power Puissance (W)	292	451	451	613	653
Potencia frig. Cooling capacity Puissance Frig. (W A -10°C)	370	687	687	951	951
Consumo Consumption Consommation (kWh/ 24h)	-				
Refrigerante Refrigerant Gaz	R-290				
Opcional Optional Options	Puertas correderas traseras / Rear sliding doors / Portes coulissantes arrière VGL 9 [KPUVGL9C+] VGL 12 [KPUVGL12C+] VGL 15 [KPUVGL15C+] VGL 18 [KPUVGL18C+] VGL 25 [KPUVGL25C+]				

Serie / Series / Série **GLACE**

+Info: www.infrico.com

VGL25C



VGL15C

Laterales / Sides / Jous

Incluidos / Includes / Inclus

Ext. Estándar / Standar / Standard

Ral 9016	Ral 1001	Ral 1018
Ral 2003	Ral 3003	Ral 3020
Ral 4007	Design 3504035	Ral 5015
Design 1107060	Ral 6002	Design 2108025
Ral 8017	Ral 9006	Ral 7016
Nogal-Walnut-Noyer	Wengué-Wenge-Wenge	Ral 9017



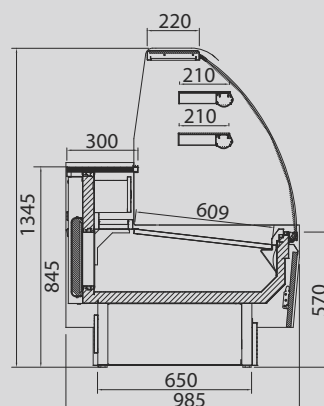

Colores fuera de carta / Colors outside of letter / Couleurs spéciales, hors palette

RAL		NO RAL	
Epoxi	Líquida/ Liquid/ Liquide	Epoxi	Líquida/ Liquid/ Liquide
[x unidad/x unit/x unité]		Consultar / Consulter / Consulter	
+10 días laborables / +10 work days / +10 jours ouvrés		Consultar / Consulter / Consulter	



VGL C

Vitrina expositora con reserva para pastelería / Pastry display case with storage / Vitrine d'exposition pour pâtisserie avec réserve réfrigérée

MODELO MODELE MODÈLE					
Precio Price Prix					
	NEUTRO / NEUTRAL / NEUTRE				
MOD.	VGL 9 PN	VGL 12 PN	VGL 15 PN	VGL 18 PN	VGL 25 PN
Precio Price Prix					
Medidas Measures Mesures (mm)	938 x 985 x 1345 mm.	1250 x 985 x 1345 mm.	1562 x 985 x 1345 mm.	1875 x 985 x 1345 mm.	2500 x 985 x 1345 mm.
Temperatura Temperature Température (°C)	4°C/+8°C				
Clase Climática Climatic class Classe climatique (°C)	3 / 25°C				
Tensión/Frecuencia Electrical data Tension électrique	230V/1ph/50Hz				
Controlador Controller Régulateur	Digital				
Material Material Matériel [EXT/INT]	Madera lacada / Lacquered wood / Bois laqué Plano exposición / Exhibition plan / Plan d'exposition: Inox Aisi 304				
Aislamiento Isolation Isolation (mm)	40kg/m ³ / Free CFC's / Zero ODP-GWP				
Capacidad Capacity Capacité (L)	163	216	271	327	430
Superficie exposición Surface exhibition Surface d'exposition (m ²)	0,9	1,2	1,5	1,8	2,5
Compresor Compressor Compresseur (HP)	-				
Estantes Shelving Étagères	2				
Costados [2] Sides [2] Joues [2] (mm)	30+30				
Sistema de frío Cooling System Système de froid	Ventilado / Ventilated / Ventilé				
Desescarche Defrost Dégivrage	Manual / Manual / Manuel				
Evaporación Evaporation Évaporation	Semiestática / Semistatic / Semiestatique				
Potencia Power Puissance (W)	292	451	451	613	653
Potencia frig. Cooling capacity Puissance Frig. (W A -10°C)	370	687	687	951	951
Consumo Consumption Consommation (kWh/ 24h)	-				
Refrigerante Refrigerant Gaz	R-290				
Opcional Optional Options	Puertas correderas traseras / Rear sliding doors / Portes coulissantes arrière VGL 9 [KPUVGL9P+] VGL 12 [KPUVGL12P+] VGL 15 [KPUVGL15P+] VGL 18 [KPUVGL18P+] VGL 25 [KPUVGL25P+]				

Serie / Series / Série **GLACE**

+Info: www.infrico.com

VGL25P



Laterales / Sides / Jous

Incluidos / Includes / Inclus

Ext. Estándar / Standar / Standard

Ral 9016	Ral 1001	Ral 1018
Ral 2003	Ral 3003	Ral 3020
Ral 4007	Design 3504035	Ral 5015
Design 1107060	Ral 6002	Design 2108025
Ral 8017	Ral 9006	Ral 7016
Nogal-Walnut-Noyer	Wengué-Wenge-Wenge	Ral 9017

Colores fuera de carta / Colors outside of letter / Couleurs spéciales, hors palette

RAL		NO RAL	
Epoxi	Líquida/ Liquid/ Liquide	Epoxi	Líquida/ Liquid/ Liquide
[x unidad/x unit/x unité]		Consultar / Consulter / Consulter	
+10 días laborables / +10 work days / +10 jours ouvrés		Consultar / Consulter / Consulter	

VGL25P

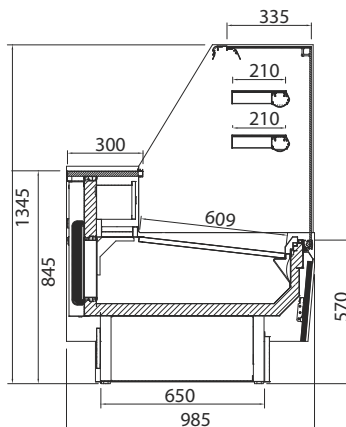

VGLP

Muebles caja /
Counter case /
Meuble caisse

Serie / Series / Série **GLACE**

MODELO MODELE MODÈLE				
	VGL 9 M	VGL 15 M	VGL 90 AAM	VGL 90 ACM
Precio Price Prix				
Medidas Measures Mesures	998 x 985 x 863 mm.	1622 x 985 x 863 mm.	1205 x 1140 x 863 mm.	1045 x 766 x 863 mm.



Laterales / Sides / Joues

Incluidos / Includes / Inclus

Ext. Estándar / Standar / Standard

Ral 9016	Ral 1001	Ral 1018
Ral 2003	Ral 3003	Ral 3020
Ral 4007	Design 3504035	Ral 5015
Design 1107060	Ral 6002	Design 2108025
Ral 8017	Ral 9006	Ral 7016
Nogel-Walnut-Noyer	Wengué-Wenge-Wenge	Ral 9017

Colores fuera de carta /
Colors outside of letter /
Couleurs spéciales, hors palette

RAL		NO RAL	
Epoxi	Líquida/ Liquid/ Liquide	Epoxi	Líquida/ Liquid/ Liquide
[x unidad/x unit/x unité]		Consultar / Consultar / Consultar	
+10 días laborables / +10 work days / +10 jours ouvrés		Consultar / Consultar / Consultar	

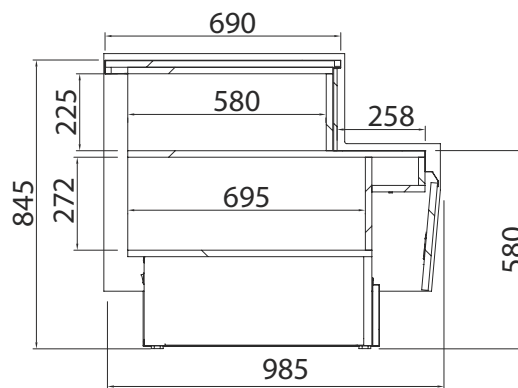





VGL M

+Info: www.infrico.com



Vitrina expositora para pastelería / Pastry display case / Vitrine d'exposition pour pâtisserie

MODELO MODELE MODÈLE					
Precio Price Prix	VNZ				
	VNZ I				
	DOBLE TEMPERATURA / DOUBLE TEMPERATURE / DOUBLE TEMPÉRATURE				
MOD.	VNZ 9 DT / IDT	VNZ 12 DT / IDT	VNZ 15 DT / IDT	VNZ 18 DT / IDT	-
Precio Price Prix	DT				
	IDT				
	CALIENTE / HOT / CHAUD				
MOD.	VNZ 9 HT	VNZ 12 HT	VNZ 15 HT	VNZ 18 HT	-
Precio Price Prix					
Medidas Measures Mesures	(mm) 938 x 915 x 1040mm.	1250 x 915 x 1040 mm.	1562 x 915 x 1040 mm.	1875 x 915 x 1040 mm.	1250 x 915 x 1040 mm.
Temperatura Temperature Température	VNZ: +4°C/+8°C DT: +4°C/+8°C HT: +40°C/+50°C				
Clase Climática Climatic class Classe climatique	3 / 25°C				
Tensión/Frecuencia Electrical data Tension électrique	230V/1ph/50Hz				
Controlador Controller Régulateur	Digital				
Material Matériel	[EXT/INT] Acero plastificado / Plastified galvanised steel / Acier galvanisé plastifié Plano exposición / Exhibition plan / Plan d'exposition: Inox Aisi 304				
Aislamiento Isolation Isolation	(mm) 40kg/m ³ / Free CFC's / Zero ODP-GWP				
Capacidad Capacity Capacité	(L) 72	96	120	144	96
Superficie exposición Surface exhibition Surface d'exposition	(m ²) 0,60	0,80	1,00	1,20	0,80
Compresor Compressor Compresseur	(HP) 1/4			1/3	1/4
Estantes Shelving Étagères	-				
Costados [2] Sides [2] Joues [2]	(mm) 20+20				
Sistema de frío Cooling System Système de froid	Ventilado / Ventilated / Ventilé				
Desescarche Defrost Dégivrage	Automático / Automatic / Automatique				
Evaporación Evaporation Évaporation	Semiestática / Semistatic / Semiestatique				
Potencia Power Puissance	VNZ / DT: 245 HT: 380	VNZ / DT: 262 HT: 510	VNZ / DT: 448 HT: 635	VNZ / DT: 454 HT: 760	650
Potencia frig. Cooling capacity Puissance Frig.	(W A -10°C) -				
Consumo Consumption Consommation	VNZ 4,2 DT: 7,7,4 HT: 7,4	VNZ 5,5 DT: 5,8/9,9 HT: 9,9	VNZ 7,6 DT: 8,2/12,4 HT: 12,4	VNZ 9,8 DT: 9,3/14,8 HT: 14,8	6,1
Refrigerante Refrigerant Gaz	R-290				
Opcional Optional Options	-				

Serie / Series / Série **NIZA**

+Info: www.infrico.com

VNZ 12HT + VNZ 15HT



Laterales / Sides / Joues

Incluidos / Includes / Inclus

Ext. Estándar / Standar / Standard

Ral 9016	Ral 1001	Ral 1018
Ral 2003	Ral 3003	Ral 3020
Ral 4007	Design 3504035	Ral 5015
Design 1107060	Ral 6002	Design 2108025
Ral 8017	Ral 9006	Ral 7016
Ral 9017		

VNZ 12 + VNZ 15

Colores fuera de carta / Colors outside of letter / Couleurs spéciales, hors palette

RAL		NO RAL	
Epoxi	Líquida/ Liquid/ Liquide	Epoxi	Líquida/ Liquid/ Liquide
[x unidad/x unit/x unité]		Consultar / Consulter / Consulter	
+10 días laborables / +10 work days / +10 jours ouvrés		Consultar / Consulter / Consulter	

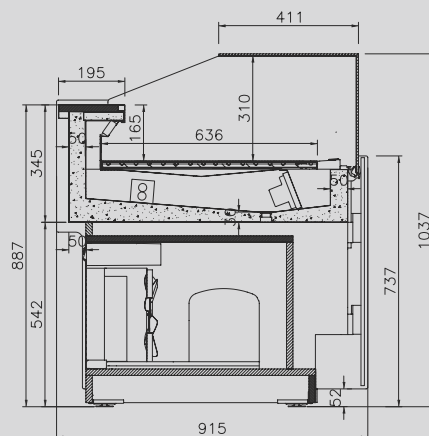

VNZ

Muebles caja / Counter case / Meuble caisse

Serie / Series / Série **NIZA**

MODELO MODELE MODÈLE							
	VNZ 9 M	VNZ 12 M	VNZ 12 MHD	VNZ 90 AAM	VNZ 45 AAM	VNZ 90 ACM	VNZ 45 ACM
Precio Price Prix							
Medidas/Measures/ Mesures [mm] Sin costados/Without sides/Sans joues	938 x 915 x 740 mm.	1250 x 915 x 740 mm.	1250 x 915 x 740 mm.	1855 x 915 x 740 mm.	1035 x 915 x 740 mm.	2325 x 915 x 740 mm.	1295 x 915 x 740 mm.

VNZ90AAM



Laterales / Sides / Joues

Incluidos / Includes / Inclus

Ext. Estándar / Standar / Standard

Ral 9016	Ral 1001	Ral 1018
Ral 2003	Ral 3003	Ral 3020
Ral 4007	Design 3504035	Ral 5015
Design 1107060	Ral 6002	Design 2108025
Ral 8017	Ral 9006	Ral 7016
Ral 9017		

Colores fuera de carta / Colors outside of letter / Couleurs spéciales, hors palette

RAL		NO RAL	
Epoxi	Líquida/ Liquid/ Liquide	Epoxi	Líquida/ Liquid/ Liquide
[x unidad/x unit/x unité]		Consultar / Consulter / Consulter	
+10 días laborables / +10 work days / +10 jours ouvrés		Consultar / Consulter / Consulter	







VNZ12M

+Info: www.infrico.com



Vitrina expositora para pastelería / Pastry display case / Vitrine d'exposition pour pâtisserie

MODELO MODELE MODÈLE					
Precio Price Prix					
	VLY 9I	VLY 12I	VLY 15I	VLY 18I	VLY 25I
Precio Price Prix					
Medidas/Measures/ Mesures [mm] Sin costados/Without sides/Sans joues	938 x 900 x 1305 mm.	1250 x 900 x 1305 mm.	1562 x 905 x 1305 mm.	1875 x 905 x 1305 mm.	2500 x 905 x 1305 mm.
Temperatura Temperature [°C] Température	4°C/+8°C				
Clase Climática Climatic class [°C] Classe climatique	3 / 25°C				
Tensión/Frecuencia Electrical data Tension électrique	230V/1ph/50Hz				
Controlador Controller Régulateur	Digital				
Material Matériel [EXT/INT]	Ext: acero plastificado / Plastified stainless steel / Acier plastifié Encimera / Worktop / Dessous: Inox Aisi 304 Plano exposición / Exhibition plan / Plan d'exposition: Acero plastif./ Plastif. Stainless steel/ Acier plastifié (Mod. VLY) - Inox Aisi 304 (Mod. I)				
Aislamiento Isolation [mm] Isolation	40kg/m ³ / Free CFC's / Zero ODP-GWP				
Capacidad Capacity [L] Capacité	72	96	120	144	192
Superficie exposición Surface exhibition [m ²] Surface d'exposition	0,60	0,80	1,00	1,20	1,60
Compresor Compressor [HP] Compresseur	1/4		1/3		1/2
Bandejas Trays (300x400) Bacs (600x400)	-				
Costados [2] Sides [2] [mm] Joues [2]	30+30				
Sistema de frío Cooling System Système de froid	Ventilado / Ventilated / Ventilé				
Desescarche Defrost Dégivrage	Manual / Manual / Manuel				
Evaporación Evaporation Évaporation	Semiestática / Semistatic / Semiestatique				
Potencia Power [W] Puissance	245	262	448	454	588
Potencia frig. Cooling capacity [W A -10°C] Puissance Frig.	-				
Consumo Consumption [kWh/ 24h] Consommation	4.2	5.5	7.6	9,8	10.3
Refrigerante Refrigerant Gaz	R-290				
Opcional Optional Options	Puertas correderas traseras / Rear sliding doors / Portes coulissantes arrière				
	[PUEVLY9CT]	[PUEVLY12CT]	[PUEVLY15CT]	[PUEVLY18CT]	[PUEVLY25CT]
	Estantes / Shelving / Étagères				
	[ESTVCB9]	[ESTVCB12]	[ESTVCB15]	[ESTVCB18]	[ESTVCB25]

Laterales no incluidos en el precio
Side panels not included in price
Joues non incluses dans le prix

Serie / Series / Série **LYON**

+Info: www.infrico.com

VLY15



Laterales / Sides / Jous

NO	
Izquierdo Left Gauche	Derecho Right Droite

Ext. Estándar / Standar / Standard

Ral 9016	Ral 1001	Ral 1018
Ral 2003	Ral 3003	Ral 3020
Ral 4007	Design 3504035	Ral 5015
Design 1107060	Ral 6002	Design 2108025
Ral 8017	Ral 9006	Ral 7016
Ral 9017		

Colores fuera de carta / Colors outside of letter / Couleurs spéciales, hors palette

RAL		NO RAL	
Epoxi	Líquida/ Liquid/ Liquide	Epoxi	Líquida/ Liquid/ Liquide
		Consultar / Consultar / Consulter	
[x unidad/x unit/x unité]			
+10 días laborables / +10 work days / +10 jours ouvrés		Consultar / Consultar / Consulter	





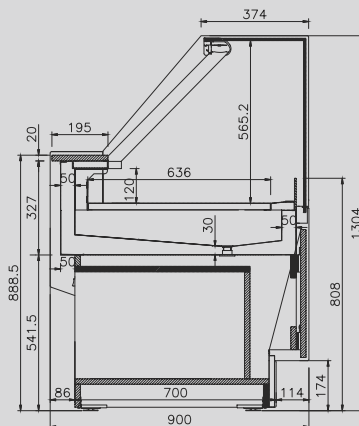

VLY9



VLY

Vitrina expositora para pastelería / Pastry display case / Vitrine d'exposition pour pâtisserie

MODELO MODELE MODÈLE	VIENNOISERIE (NEUTRA/NEUTRAL/NEUTRE)		CHOCOLATE / CHOCOLAT	BAIN MARIE (CALIENTE/HOT/CHAUD)	
	 VLY 9 V	 VLY 12 V	 VLY 12 B / VLY 12 IB	 VLY 12 BMS	 VLY 15 BMS
Precio Price Prix					
Medidas/Measures/ Mesures [mm] Sin costados/Without sides/Sans joues	938 x 900 x 1550 mm.	1250 x 900 x 1550 mm.	1250 x 900 x 1060 mm.	1250 x 900 x 1305 mm.	1562 x 900 x 1305 mm.
Temperatura Temperature [°C] Température	-		+7°C/+12°C	+60°C/+70°C	
Clase Climática Climatic class [°C] Classe climatique	3 / 25°C				
Tensión/Frecuencia Electrical data Tension électrique	230V/1ph/50Hz				
Controlador Controller Régulateur	Digital				
Material Matériel [EXT/INT]	Ext: acero plastificado / Plastified stainless steel / Acier plastifié Encimera / Worktop / Dessous: Inox Aisi 304 Plano exposición / Exhibition plan / Plan d'exposition: Acero plastif./ Plastif. Stainless steel/ Acier plastifié (Mod. V/B/BMS) - Inox Aisi 304 (Mod. I)				
Aislamiento Isolation [mm]	40kg/m ³ / Free CFC's / Zero ODP-GWP				
Capacidad Capacity [L] Capacité	184	245	96	78	163
Superficie exposición Surface exhibition [m ²] Surface d'exposition	1,13	1,50	0,80	0,69	0,86
Compresor Compressor [HP] Compresseur	-	-	1/5	-	-
Bandejas Trays (300x400) Bacs (600x400)		-		3	4
Costados [2] Sides [2] [mm] Joues [2]	30+30				
Sistema de frío Cooling System Système de froid	Ventilado / Ventilated / Ventilé				
Desescarche Defrost Dégivrage	Manual / Manual / Manuel				
Evaporación Evaporation Évaporation	Semiestática / Semistatic / Semiestatique				
Potencia Power [W] Puissance	45	70	795	2050	3050
Potencia frig. Cooling capacity [W A -10°C] Puissance Frig.	-	-	254	-	-
Consumo Consumption [kWh/ 24h] Consommation	0,6	1	6,1	12,3	18,3
Refrigerante Refrigerant Gaz	R-290				
Opcional Optional Options	-		Puertas correderas traseras / Rear sliding doors / Portes coulissantes arrière [PUEVLY12CTB]	-	

Laterales no incluidos en el precio
Side panels not included in price
Joues non incluses dans le prix

Serie / Series / Série **LYON VIENNOISERIE**
 Serie / Series / Série **LYON CHOCOLATE/CHOCOLAT**
 Serie / Series / Série **LYON BAIN MARIE**

+Info: www.infrico.com

Vitrina Baño María para servicio de comida caliente
 Display case Bain Marie for food service
 Vitrine Bain Marie pour plats chauds

VLY12BMS



VLY12B

Vitrina para venta de chocolates
 Display case for chocolate sale
 Vitrine pour la vente de chocolats



Puertas correderas traseras de serie
 Rear sliding doors standard
 Portes coulissantes arrière à série

Laterales / Sides / Jous

VLY V/BMS
 Incluidos / Includes / Inclus

Laterales / Sides / Jous

NO	
Izquierdo Left Gauche	Derecho Right Droite



Neutro
Neutral
Neutre

3 estantes de serie
 3 shelves standard
 3 étagères à série

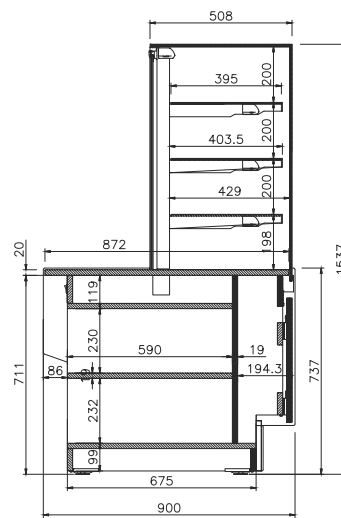

VLY9V

VLY V

Ext. Estándar / Standar / Standard

Ral 9016	Ral 1001	Ral 1018
Ral 2003	Ral 3003	Ral 3020
Ral 4007	Design 3504035	Ral 5015
Design 1107060	Ral 6002	Design 2108025
Ral 8017	Ral 9006	Ral 7016
Ral 9017		

Colores fuera de carta /
 Colors outside of letter /
 Couleurs spéciales, hors palette

RAL		NO RAL	
Epoxi	Líquida/ Liquid/ Liquide	Epoxi	Líquida/ Liquid/ Liquide
(x unidad/x unit/x unité)		Consultar / Consulter / Consulter	
+10 días laborables / +10 work days / +10 jours ouvrés		Consultar / Consulter / Consulter	

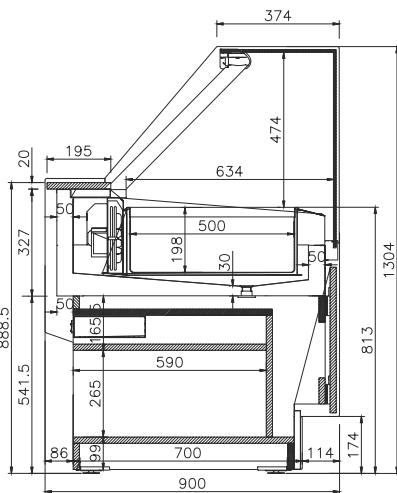



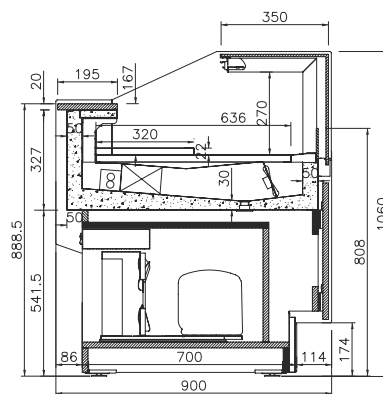

VLY BMS



VLY B

Vitrina expositora para pastelería cristal bajo / Pastry display case low glass / Vitrine d'exposition pour pâtisserie vitre basse

MODELO MODELE MODÈLE					
Precio Price Prix					
	VLY 9 ILG	VLY 12 ILG	VLY 15 ILG	VLY 18 ILG	VLY 25 ILG
Precio Price Prix					
Medidas/Measures/ Mesures [mm] Sin costados/Without sides/Sans joues	938 x 900 x 1060 mm.	1250 x 900 x 1060 mm.	1562 x 900 x 1060 mm.	1875 x 900 x 1060 mm.	2500 x 900 x 1060 mm.
Temperatura Temperature [°C] Température	+4°C/+8°C				
Clase Climática Climatic class [°C] Classe climatique	3 / 25°C				
Tensión/Frecuencia Electrical data Tension électrique	230V/1ph/50Hz				
Controlador Controller Régulateur	Digital				
Material Matériel [EXT/INT]	Ext: acero plastificado / Plastified stainless steel / Acier plastifié Encimera / Worktop / Dessous: Inox Aisi 304 Plano exposición / Exhibition plan / Plan d'exposition: Acero plastif./ Plastif. Stainless steel/ Acier plastifié (Mod. LG) - Inox Aisi 304 (Mod. I)				
Aislamiento Isolation [mm] Isolation	40kg/m ³ / Free CFC's / Zero ODP-GWP				
Capacidad Capacity [L] Capacité	72	96	120	144	192
Superficie exposición Surface exhibition [m ²] Surface d'exposition					
Compresor Compressor [HP] Compresseur	1/4		1/3		1/2
Bandejas Trays (300x400) Bacs (600x400)	-				
Costados [2] Sides [2] [mm] Joues [2]	30+30				
Sistema de frío Cooling System Système de froid	Ventilado / Ventilated / Ventilé				
Desescarche Defrost Dégivrage	Manual / Manual / Manuel				
Evaporación Evaporation Évaporation	Semiestática / Semistatic / Semiestatique				
Potencia Power [W] Puissance	245	262	448	454	588
Potencia frig. Cooling capacity [W A -10°C] Puissance Frig.	-				
Consumo Consumption [kWh/ 24h] Consommation	4.2	5.5	7.6	9,8	10.3
Refrigerante Refrigerant Gaz	R-290				
Opcional Optional Options	Puertas correderas traseras / Rear sliding doors / Portes coulissantes arrière [PUEVLY9CTB]	Puertas correderas traseras / Rear sliding doors / Portes coulissantes arrière [PUEVLY12CT]	Puertas correderas traseras / Rear sliding doors / Portes coulissantes arrière [PUEVLY15CTB]	Puertas correderas traseras / Rear sliding doors / Portes coulissantes arrière [PUEVLY18CTB]	Puertas correderas traseras / Rear sliding doors / Portes coulissantes arrière [PUEVLY25CTB]

Laterales no incluidos en el precio
Side panels not included in price
Joues non incluses dans le prix

Serie / Series / Série **LYON LG**

+Info: www.infrico.com

VLY15LG



Laterales / Sides / Jous

NO	
Izquierdo Left Gauche	Derecho Right Droite

Ext. Estándar / Standar / Standard

Ral 9016	Ral 1001	Ral 1018
Ral 2003	Ral 3003	Ral 3020
Ral 4007	Design 3504035	Ral 5015
Design 1107060	Ral 6002	Design 2108025
Ral 8017	Ral 9006	Ral 7016
Ral 9017		



VLY12LG

**Colores fuera de carta /
Colors outside of letter /
Couleurs spéciales, hors palette**

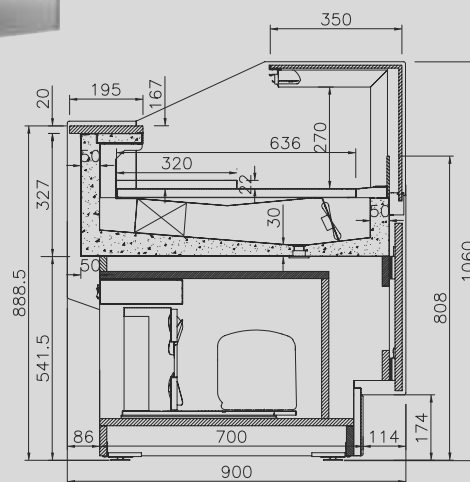

RAL		NO RAL	
Epoxi	Líquida/ Liquid/ Liquide	Epoxi	Líquida/ Liquid/ Liquide
[x unidad/x unit/x unité]		Consultar / Consultar / Consultar	
+10 días laborables / +10 work days / +10 jours ouvrés		Consultar / Consultar / Consultar	



VLY LG

Muebles caja /
Counter case /
Meuble caisse

Serie / Series / Série LYON

MODELO MODELE MODÈLE							
Precio Price Prix							
Medidas/Measures/ Mesures [mm] Sin costados/Without sides/Sans joues	938 x 900 x 745 mm.	1250 x 900 x 745 mm.	1250 x 900 x 745 mm.	1035 x 900 x 745 mm.	1855 x 900 x 745 mm.	1295 x 900 x 745 mm.	2325 x 900 x 745 mm.

VLY12MHD



HANDICAPÉ

Laterales/ Sides / Jous

Incluidos / Includes / Inclus

Ext. Estándar / Standar / Standard

Ral 9016	Ral 1001	Ral 1018
Ral 2003	Ral 3003	Ral 3020
Ral 4007	Design 3504035	Ral 5015
Design 1107060	Ral 6002	Design 2108025
Ral 8017	Ral 9006	Ral 7016
Ral 9017		

Colores fuera de carta /
Colors outside of letter /
Couleurs spéciales, hors palette

RAL		NO RAL	
Epoxi	Líquida/ Liquid/ Liquide	Epoxi	Líquida/ Liquid/ Liquide
[x unidad/x unit/x unité]		Consultar / Consulter / Consulter	
+10 días laborables / +10 work days / +10 jours ouvrés		Consultar / Consulter / Consulter	







VLY9M

+Info: www.infrico.com



Los datos técnicos están sujetos a posibles variaciones que serán actualizadas periódicamente en las fichas técnicas del producto, disponibles en la web /
The technical data are subject to possible variations that will be updated periodically in the technical data sheets of the product, which are available on the website /
Les données techniques peuvent varier et seront actualisées dans les fiches techniques du produit, disponibles sur le site web.

Vitrina expositora para pastelería / Pastry display case / Vitrine d'exposition pour pâtisserie

MODELO MODELE MODÈLE									
Precio Price Prix	R IR	-	VBR 9 R/IR	VBR 12 R/IR	VBR 18 R/IR				
MOD.		-	CALIENTE / HOT / CHAUD						
Precio Price Prix	HT IHT	-	VBR 9 HT/IHT	VBR 12 HT/IHT	VBR 18 HT/IHT				
MOD.		-	AUTOSERVICIO / SELF SERVICE / LIBRE SERVICE						
Precio Price Prix	SS ISS	VBR 6 SS/ISS	VBR 9 SS/ISS	VBR 12 SS/ISS	VBR 18 SS/ISS				
MOD.		-	DOBLE SERVICIO / DOUBLE SERVICE / DOUBLE SERVICE						
Precio Price Prix	DS IDS	-	VBR 9 DS/IDS	VBR 12 DS/IDS	VBR 18 DS/IDS				
Medidas/Measures/ Mesures (mm) Sin costados/Without sides/Sans joues		625 x 810 x 1300 mm.	938 x 810 x 1300 mm.	1250 x 810 x 1300 mm.	1875 x 810 x 1300 mm.				
Temperatura Temperature Température (°C)		R / SS / DS: +4°C/+8°C HT: +55°C/+60°C							
Clase Climática Climatic class Classe climatique (°C)		3 / 25°C							
Tensión/Frecuencia Electrical data Tension électrique		230V/1ph/50Hz							
Controlador Controller Régulateur		Digital							
Material Material Matériel (EXT/INT)		Ext: acero plastificado / Plastified stainless steel / Acier plastifié Encimera / Worktop / Dessous: Inox Aisi 304 Plano exposición / Exhibition plan / Plan d'exposition: Acero plastif./Plastif. Stainless steel/Acier plastifié (R/HT/SS/DS) - Inox Aisi 304 (Mod. I)							
Aislamiento Isolation Isolation (mm)		40kg/m ³ / Free CFC's / Zero ODP-GWP							
Capacidad Capacity Capacité (L)		180	274	365	548				
Superficie exposición Surface exhibition Surface d'exposition (m ²)		0,9	1,4	1,9	2,8				
Compresor Compressor Compresseur (HP)		1/3	3/4	3/4 DS: 1	1 1/4				
Puertas / Estantes Doors / Shelving Portes / Étagères		R: - SS: - / 3	HT: - DS: -	R: 2 / 3 SS: - / 3	HT: 2 / 2 DS: 2 / 3	R: 2 / 3 SS: - / 3	HT: 2 / 2 DS: 2 / 3	R: 2 / 3 SS: - / 3	HT: 2 / 2 DS: 2 / 4
Costados (2) Sides (2) Joues (2) (mm)		30+30							
Sistema de frío Cooling System Système de froid		Ventilado / Ventilated / Ventilé							
Desescarche Defrost Dégivrage		Automático / Automatic / Automatique							
Evaporación Evaporation Évaporation		Semiestática / Semistatic / Semiestatique							
Potencia Power Puissance (W)		R: - SS: 404	HT: - DS: -	R: 708 SS: 708	HT: 1080 DS: 708	R: 722 SS: 722	HT: 1107 DS: 815	R: 1223 SS: 1223	HT: 1125 DS: 1223
Potencia frig. Cooling capacity Puissance Frig. (W A -10°C)		750	1096	1315	2192				
Consumo Consumption Consommation (kWh/ 24h)		R: - SS: 5.65	HT: - DS: -	R: 8.5 SS: 9.25	HT: 9.85 DS: 7.54	R: 9.7 SS: 9.49	HT: 10.4 DS: 9.95	R: 14.5 SS: 15.8	HT: 10.8 DS: 14.9
Refrigerante Refrigerant Gaz		R-290							
Opcional Optional Options		Cristal frontal doble / Double front glass / Double front glass VBR 9 VBR 12 VBR 18							

*Este precio es aplicable cuando el cristal va incorporado en el mueble.
This price is applicable when the glass is incorporated with the display case.
Prix applicable quand la vitre est livrée dans la vitrine

Serie / Series / Série **AMBAR**

+Info: www.infrico.com

VBR12HT



VBR12R



VBR6SS



VBR12DS



VBR SS/DS

VBR R/DS/HT



Laterales / Sides / Joues

Incluidos / Includes / Inclus

Ext. Estándar / Standar / Standard

Ral 9016	Ral 1001	Ral 1018
Ral 2003	Ral 3003	Ral 3020
Ral 4007	Design 3504035	Ral 5015
Design 1107060	Ral 6002	Design 2108025
Ral 8017	Ral 9006	Ral 7016
Nogal-Walnut-Noyer	Wengué-Wenge-Wenge	Ral 9017

Colores fuera de carta / Colors outside of letter / Couleurs spéciales, hors palette

RAL		NO RAL	
Epoxi	Líquida/ Liquid/ Liquide	Epoxi	Líquida/ Liquid/ Liquide
[x unidad/x unit/x unité]		Consultar / Consultar / Consultar	
+10 días laborables / +10 work days / +10 jours ouvrés		Consultar / Consultar / Consultar	

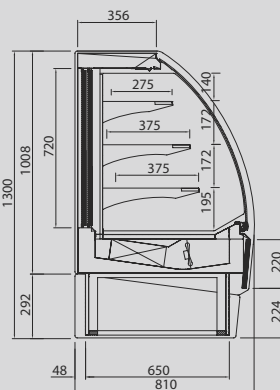

VBR R / DS

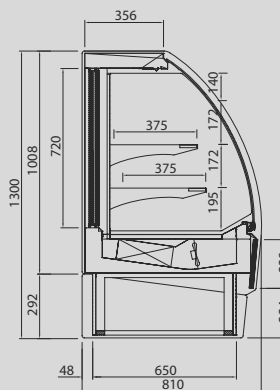

VBR HT

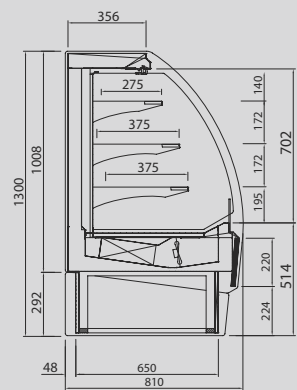

VBR SS

Vitrina expositora para pastelería / Pastry display case / Vitrine d'exposition pour pâtisserie

MODELO
MODELE
MODÈLE



VBR 9 PR/IPR



VBR 12 PR/IPR



VBR 18 PR/IPR

Precio Price Prix	PR IPR			
-------------------------	-----------	--	--	--

MOD.		VBR 9 PHT/IPHT	CALIENTE / HOT / CHAUD VBR 12 PHT/IPHT		VBR 18 PHT/IPHT
Precio Price Prix	PHT IPHT				
Medidas/Measures/ Mesures (mm) Sin costados/Without sides/Sans joues		938 x 810 x 1300 mm.	1250 x 810 x 1300 mm.	1875 x 810 x 1300 mm.	
Temperatura Temperature Température	(°C)		PR: +4°C/+8°C PHT: +55°C/+60°C		
Clase Climática Climatic class Classe climatique	(°C)		3 / 25°C		
Tensión/Frecuencia Electrical data Tension électrique			230V/1ph/50Hz		
Controlador Controller Régulateur			Digital		
Material Matériel	[EXT/INT]	Ext: acero plastificado / Plastified stainless steel / Acier plastifié Encimera / Worktop / Dessous: Inox Aisi 304 Plano exposición / Exhibition plan / Plan d'exposition: Acero plastif. / Plastif. Stainless steel/ Acier plastifié (PR/PHT) - Inox Aisi 304 (Mod. I)			
Aislamiento Isolation Isolation	(mm)	40kg/m ³ / Free CFC's / Zero ODP-GWP			
Capacidad Capacity Capacité	(L)	274	365	548	
Superficie exposición Surface exhibition Surface d'exposition	(m ²)	1,4	1,9	2,8	
Compresor Compressor Compresseur	(HP)	3/4	3/4	1 1/4	
Puertas / Estantes Doors / Shelving Portes / Étagères		R: 2 / 3 HT: 2 / 2	R: 2 / 3 HT: 2 / 2	R: 2 / 3 HT: 2 / 2	
Costados [2] Sides [2] Joues [2]	(mm)	20+20			
Sistema de frío Cooling System Système de froid		Ventilado / Ventilated / Ventilé			
Desescarche Defrost Dégivrage		Manual / Manual / Manuel			
Evaporación Evaporation Évaporation		Semiestática / Semistatic / Semiestatique			
Potencia Power Puissance	(W)	R: 708 HT: 1080	R: 722 HT: 1107	R: 1223 HT: 1125	
Potencia frig. Cooling capacity Puissance Frig.	(W A -10°C)	1096	1315	2192	
Consumo Consumption Consommation	(kWh/ 24h)	R: 8.5 HT: 9.85	R: 9.7 HT: 10.4	R: 14.5 HT: 10.8	
Refrigerante Refrigerant Gaz		R-290			
Opcional Optional Options		-			

Serie / Series / Série **AMBAR**

+Info: www.infrico.com

VBR12PR



Posibilidad de intercalar módulo Self Service (consultar)
 Possibility of adding a Self-Service module (contact us)
 Possibilité d'intercaler le module Self Service (nous contacter)



Laterales / Sides / Jous

Incluidos / Includes / Inclus

Ext. Estándar / Standar / Standard

Ral 9016	Ral 1001	Ral 1018
Ral 2003	Ral 3003	Ral 3020
Ral 4007	Design 3504035	Ral 5015
Design 1107060	Ral 8002	Design 2108025
Ral 8017	Ral 9006	Ral 7016
Nogal-Walnut-Noyer	Wengué-Wenge-Wenge	Ral 9017

Colores fuera de carta / Colors outside of letter / Couleurs spéciales, hors palette

RAL		NO RAL	
Epoxi	Líquida/Liquid/Liquide	Epoxi	Líquida/Liquid/Liquide
[x unidad/x unit/x unité]		Consultar / Consulter / Consulter	
+10 días laborables / +10 work days / +10 jours ouvrés		Consultar / Consulter / Consulter	

VBR12PHT

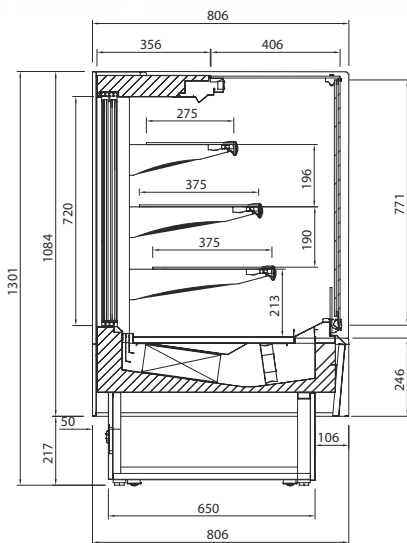

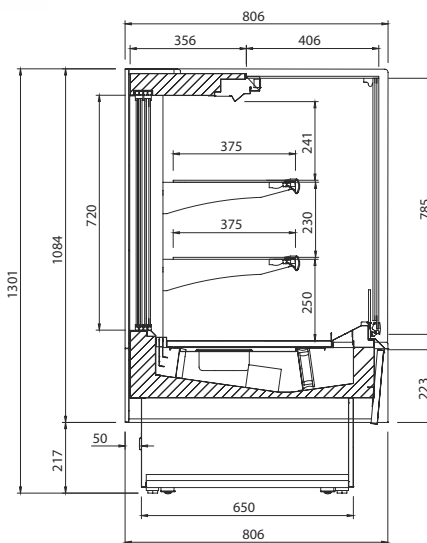

VBR PR



VBR PHT

Vitrina expositora para pastelería / Pastry display case / Vitrine d'exposition pour pâtisserie

MODELO MODELE MODÈLE			
Precio Price Prix			
	CALIENTE / HOT / CHAUD		
MOD.	VON 9 PHT	VON 12 PHT	VON 18 PHT
Precio Price Prix			
Medidas/Measures/ Mesures (mm) Sin costados/Without sides/Sans joues	938 x 810 x 1300 mm.	1250 x 810 x 1300 mm.	1875 x 810 x 1300 mm.
Temperatura Temperature (°C) Température	PR: +4°C/+8°C PHT: +55°C/+60°C		
Clase Climática Climatic class (°C) Classe climatique	3 / 25°C		
Tensión/Frecuencia Electrical data Tension électrique	230V/1ph/50Hz		
Controlador Controller Régulateur	Digital		
Material Material [EXT/INT] Matériel	Aisi 304		
Aislamiento Isolation (mm) Isolation	40kg/m ³ / Free CFC's / Zero ODP-GWP		
Capacidad Capacity (L) Capacité	274	365	548
Superficie exposición Surface exhibition (m ²) Surface d'exposition	1,4	1,9	2,8
Compresor Compressor (HP) Compresseur	1/2	3/4	1 1/4
Puertas / Estantes Doors / Shelving Portes / Étagères	PR: 2 / 3 PHT: 2 / 2	PR: 2 / 3 PHT: 2 / 3	PR: 3 / 3 PHT: 3 / 2
Costados [2] Sides [2] (mm) Joues [2]	20+20		
Sistema de frío Cooling System Système de froid	Ventilado / Ventilated / Ventilé		
Desescarche Defrost Dégivrage	Manual / Manual / Manuel		
Evaporación Evaporation Évaporation	Semiestática / Semistatic / Semiestatique		
Potencia Power (W) Puissance	PR: 708 HT: 1080	PR: 722 HT: 1107	PR: 1223 HT: 1125
Potencia frig. Cooling capacity (W A -10°C) Puissance Frig.	1096	1315	1840
Consumo Consumption (kWh/ 24h) Consommation	PR: 8.5 HT: 9.85	PR: 9.7 HT: 10.4	PR: 14.5 HT: 10.8
Refrigerante Refrigerant Gaz	R-290		
Opcional Optional Options	-		

Serie / Series / Série **ONIX**

+Info: www.infrico.com

VON12PR



VON12PHT



Laterales / Sides / Joes

Incluidos / Includes / Inclus

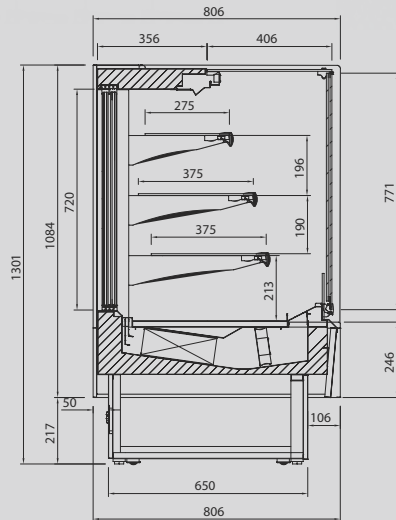



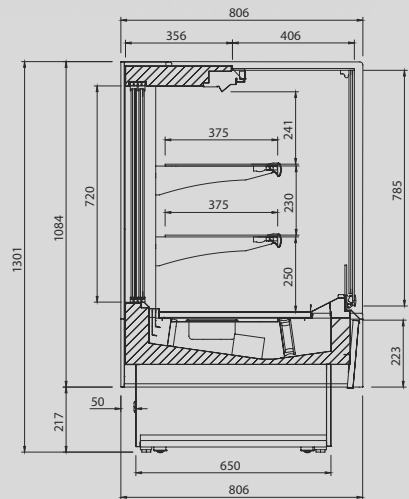

VON PR



VON PHT



Vitrina expositora para pastelería / Pastry display case / Vitrine d'exposition pour pâtisserie

MODELO MODELE MODÈLE				
Precio Price Prix				
MOD.	-	CALIENTE / HOT / CHAUD VON 9 HT		VON 12 HT
Precio Price Prix				
MOD.	VON 6 SS	AUTOSERVICIO / SELF SERVICE / LIBRE SERVICE VON 9 SS		VON 12 SS
Precio Price Prix				
MOD.	-	DOBLE SERVICIO / DOUBLE SERVICE / DOUBLE SERVICE VON 9 DS		VON 12 DS
Precio Price Prix				
Medidas/Measures/ Mesures [mm] Sin costados/Without sides/Sans joues	1625 x 810 x 1300 mm.	938 x 810 x 1300 mm.	1250 x 810 x 1300 mm.	1875 x 810 x 1300 mm.
Temperatura Temperature Température [°C]	R / SS / DS: +4°C/+8°C HT: +55°C/+65°C			
Clase Climática Climatic class Classe climatique [°C]	3 / 25°C			
Tensión/Frecuencia Electrical data Tension électrique	230V/1ph/50Hz			
Controlador Controller Régulateur	Digital			
Material Material Matériel [EXT/INT]	AISI 304			
Aislamiento Isolation Isolation [mm]	40kg/m ³ / Free CFC's / Zero ODP-GWP			
Capacidad Capacity Capacité [L]	180	274	365	548
Superficie exposición Surface exhibition Surface d'exposition [m ²]	0,9	1,4	1,9	2,8
Compresor Compressor Compresseur [HP]	1/3	3/4	3/4 DS: 1	1 1/4
Puertas / Estantes Doors / Shelving Portes / Étagères	R: - SS: - / 3	HT: - DS: -	R: 2 / 3 SS: - / 3	HT: 2 / 2 DS: 2 / 3
Costados [2] Sides [2] Joues [2] [mm]	30+30			
Sistema de frío Cooling System Système de froid	Ventilado / Ventilated / Ventilé			
Desescarche Defrost Dégivrage	Automático / Automatic / Automatique			
Evaporación Evaporation Évaporation	Semiestática / Semistatic / Semi-statique			
Potencia Power Puissance [W]	R: - SS: 404	HT: - DS: -	R: 708 SS: 708	HT: 1080 DS: 708
Potencia frig. Cooling capacity Puissance Frig. [W A -10°C]	750		1096	1315
Consumo Consumption Consommation [kWh/ 24h]	R: - SS: 5.65	HT: - DS: -	R: 8.5 SS: 9.25	HT: 9.85 DS: 7.54
Refrigerante Refrigerant Gaz	R-290			
Opcional Optional Options	Cristal frontal doble / Double front glass / Double front glass VON 9 VON 12 VON 18			

*Este precio es aplicable cuando el cristal va incorporado en el mueble.
This price is applicable when the glass is incorporated with the display case.
Prix applicable quand la vitre est livrée dans la vitrine

Serie / Series / Série **VON**

+Info: www.infrico.com

VON HT



VON SS



Laterales / Sides / Joues

Incluidos / Includes / Inclus

OPCIONAL Cristal frontal doble
OPTIONAL Double frontal glass
OPTION Double vitrage frontale

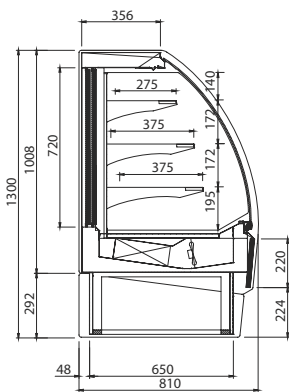

VNO R / DS

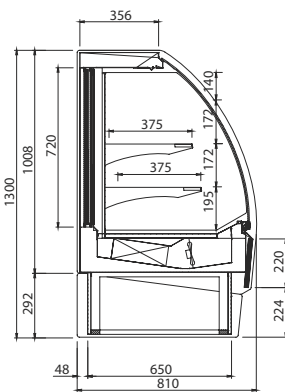



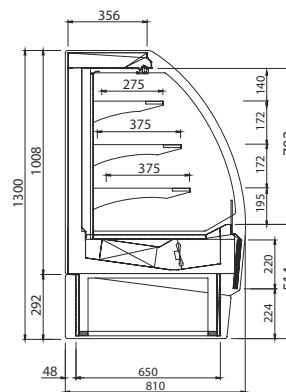

VON HT



VON SS

Vitrina expositora para cafetería y pastelería/ Pastry display case / Vitrine d'exposition pour cafétéria et pâtisserie

MODELO MODELE MODÈLE	 VCO 9	 VCO 12	 VCO 15	 VCO 18
Precio Price Prix				
Medidas / Measures / Mesures (mm)	998 x 890 x 1455 mm.	1310 x 890 x 1455 mm.	1622 x 890 x 1455 mm.	1935 x 890 x 1455 mm.
Temperatura Temperature Température (°C)	+2°C/+5°C			
Clase Climática Climatic class Classe climatique (°C)	3 / 25°C			
Tensión/Frecuencia Electrical data Tension électrique	230V/1ph/50Hz			
Controlador Controller Régulateur	Digital			
Material Material Matériel (EXT/INT)	Acero plastificado / Plastified galvanised steel / Acier galvanisé plastifié Plano exposición / Exhibition plan / Plan d'exposition: Inox Aisi 304			
Aislamiento Isolation Isolation (mm)	40kg/m ³ / Free CFC's / Zero ODP-GWP			
Capacidad Capacity Capacité (L)	186	248	310	372
Superficie exposición Surface exhibition Surface d'exposition (m ²)	1.13	1.51	1.88	2.26
Compresor Compressor Compresseur (HP)	5/8	3/4	7/8	1
Estantes Shelving Étagères	1			
Costados (2) Sides (2) Joues (2) (mm)	20+20			
Sistema de frío Cooling System Système de froid	Ventilado / Ventilated / Ventilé			
Desescarche Defrost Dégivrage	Manual / Manual / Manuel			
Evaporación Evaporation Évaporation	Semiestática / Semistatic / Semiestatique			
Potencia Power Puissance (W)	436	616	682	740
Potencia frig. Cooling capacity Puissance Frig. (-10°C)	-			
Consumo Consumption Consommation (kWh/24h)	6,3	9,02	10,3	11,8
Refrigerante Refrigerant Gaz	R-290			
Opcional Optional Options	-			

Serie / Series / Série **COMBO**

+Info: www.infrico.com



Laterales / Sides / Joues





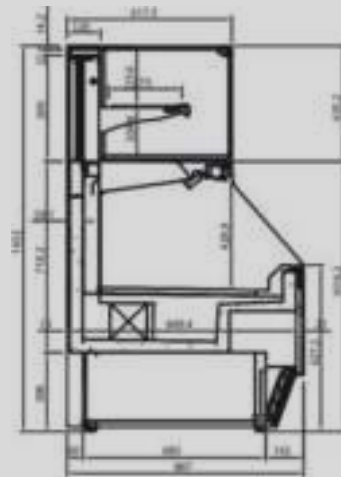

Incluidos / Includes / Inclus



VC015



Vitrina expositora frío ventilado con reserva, modular, para cafetería y pastelería/ Refrigerated modular pastry display case with storage / Vitrine d'exposition froid ventilé avec réserve, modulaire, pour cafétéria et pâtisserie

MODELO MODELE MODÈLE						
	VMG 9 RU	VMG 12 RU	VMG 15 RU	VMG 18 RU	VMG 25 RU	VMG 12 B
Precio Price Prix						
Medidas/Measures/ Mesures [mm] Sin costados/Without sides/Sans joues	938 x 960 x 1220 mm.	1250 x 960 x 1220 mm.	1562 x 960 x 1220 mm.	1875 x 960 x 1220 mm.	2500 x 960 x 1220 mm.	1250 x 960 x 1020 mm.
Temperatura Temperature [°C] Température	+4°C/+8°C					+7°C/+12°C
Clase Climática Climatic class [°C] Classe climatique	3 / 25°C					
Tensión/Frecuencia Electrical data Tension électrique	230V/1ph/50Hz					
Controlador Controller Régulateur	Digital					
Material Matériel [EXT/INT]	Ext: acero plastificado / Plastified steel / Acier plastifié Plano exposición / Exhibition plan / Plan d'exposition: Acero plastif. negro / Black plastif. Stainless steel / Acier plastifié noir					
Aislamiento Isolation [mm]	40kg/m ³ / Free CFC's / Zero ODP-GWP					
Capacidad Capacity [L] Capacité	106	141	177	212	283	141
Superficie exposición Surface exhibition [m ²] Surface d'exposition	0,13	0,17	0,22	0,26	0,35	0,17
Compresor Compressor [HP] Compresseur	1/3	1/3	1/2	3/4	1	-
Estantes / Puertas Shelving / Doors Étagères / Portes	1 Estante					
Costados [2] Sides [2] [mm] Joues [2]	30 + 30					
Sistema de frío Cooling System Système de froid	Ventilado / Ventilated / Ventilé					
Desescarche Defrost Dégivrage	Automático / Automatic / Automatique					
Evaporación Evaporation Évaporation	Ventilado / Ventilated / Ventilé					
Potencia Power [W] Puissance	419	430	588	654	857	430
Potencia frig. Cooling capacity [W A -10°C] Puissance Frig.	-					
Consumo Consumption [kWh/ 24h] Consommation	6,04	6,2	8,5	9,4	12,3	6,2
Refrigerante Refrigerant Gaz	R290					
Opcional Optional Options	Puertas correderas traseras Rear sliding doors Portes arrières coulissantes VMG 9 R PUEVMG9CT VMG 12 R PUEVMG12CT VMG 15 R PUEVMG15CT VMG 18 R PUEVMG18CT VMG 25 R PUEVMG25CT					-

Laterales no incluidos en el precio
Side panels not included in price
Joues non incluses dans le prix

NEW

Series / Série **MAGNUS**

+Info: www.infrico.com

VMG25RU

Estante de serie
Standard shelv
Étagère standard

Laterales / Sides / Joues

NO	
Izquierdo Left Gauche	Derecho Right Droite

Ext. Estándar / Standar / Standard

Ral 9016	Ral 1001	Ral 1018
Ral 2003	Ral 3003	Ral 3020
Ral 4007	Design 3504035	Ral 5015
Design 1107060	Ral 6002	Design 2108025
Ral 8017	Ral 9006	Ral 7016
Nogal-Walnut-Noyer	Wengué-Wenge-Wenge	Ral 9017

**Colores fuera de carta /
Colors outside of letter /
Couleurs spéciales, hors palette**



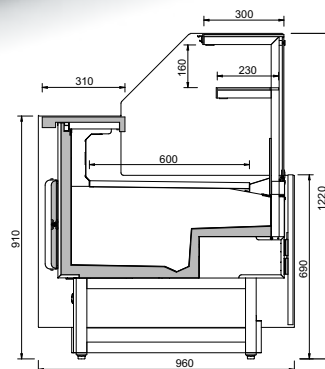

RAL		NO RAL	
Epoxi	Líquida/ Liquid/ Liquide	Epoxi	Líquida/ Liquid/ Liquide
[x unidad/x unit/x unité]		Consultar / Consultar / Consultar	
+10 días laborables / +10 work days / +10 jours ouvrés		Consultar / Consultar / Consultar	



VMG RU



Vitrina expositora frío ventilado con reserva, modular, para cafetería y pastelería, cristal bajo/
Refrigerated modular pastry display case with storage, low glass /
Vitrine d'exposition froid ventilé avec réserve, modulaire, pour cafétéria et pâtisserie, verre bas

MODELO MODELE MODÈLE					
Precio Price Prix					
Medidas/Measures/ Mesures (mm) Sin costados/Without sides/Sans joues	938 x 960 x 1020 mm.	1250 x 960 x 1020 mm.	1562 x 960 x 1020 mm.	1875 x 960 x 1020 mm.	2500 x 960 x 1020 mm.
Temperatura Temperature (°C) Température	+4°C/+8°C				
Clase Climática Climatic class (°C) Classe climatique	3 / 25°C				
Tensión/Frecuencia Electrical data Tension électrique	230V/1ph/50Hz				
Controlador Controller Régulateur	Digital				
Material Material (EXT/INT) Matériel	Ext: acero plastificado / Plastified steel / Acier plastifié Plano exposición / Exhibition plan / Plan d'exposition: Acero plastif. negro / Black plastif. Stainless steel / Acier plastifié noir				
Aislamiento Isolation (mm) Isolation	40kg/m ³ / Free CFC's / Zero ODP-GWP				
Capacidad Capacity (L) Capacité	106	141	177	212	283
Superficie exposición Surface exhibition (m ²) Surface d'exposition	0,13	0,17	0,22	0,26	0,35
Compresor Compressor (HP) Compresseur	1/3	1/3	1/2	3/4	1
Estantes / Puertas Shelving / Doors Étagères / Portes	-				
Costados (2) Sides (2) (mm) Joues (2)	30 + 30				
Sistema de frío Cooling System Système de froid	Ventilado / Ventilated / Ventilé				
Desescarche Defrost Dégivrage	Automático / Automatic / Automatique				
Evaporación Evaporation Évaporation	Ventilado / Ventilated / Ventilé				
Potencia Power (W) Puissance	379	388	544	606	722
Potencia frig. Cooling capacity (W A -10°C) Puissance Frig.	-				
Consumo Consumption (kWh/ 24h) Consommation	5,01	5,12	7,18	8,00	9,53
Refrigerante Refrigerant Gaz	R290				
Opcional Optional Options	-				

Laterales no incluidos en el precio
Side panels not included in price
Joues non incluses dans le prix

NEW

Series / Série **MAGNUS**

+Info: www.infrico.com

VMG25LG

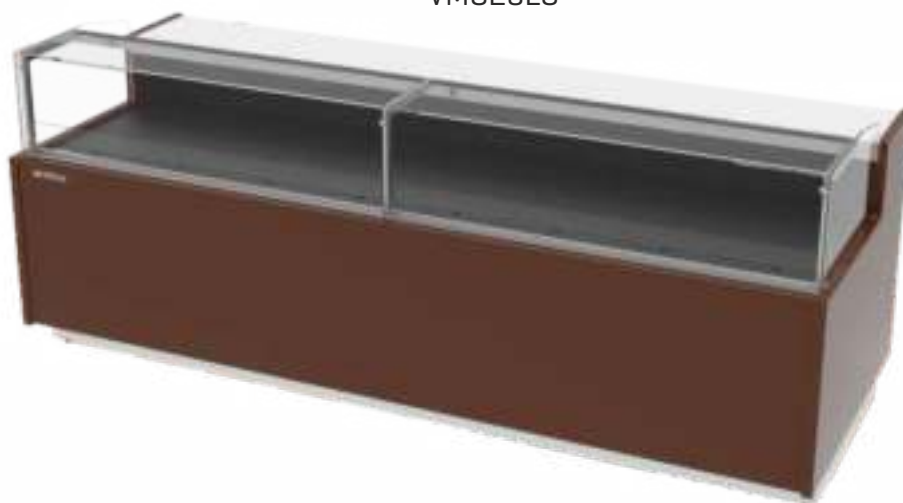

Laterales / Sides / Jous

NO	
Izquierdo Left Gauche	Derecho Right Droite

Ext. Estándar / Standar / Standard

Ral 9016	Ral 1001	Ral 1018
Ral 2003	Ral 3003	Ral 3020
Ral 4007	Design 3504035	Ral 5015
Design 1107060	Ral 6002	Design 2108025
Ral 8017	Ral 9006	Ral 7016
Nogal-Walnut-Noyer	Wengué-Wenge-Wenge	Ral 9017

Colores fuera de carta / Colors outside of letter / Couleurs spéciales, hors palette



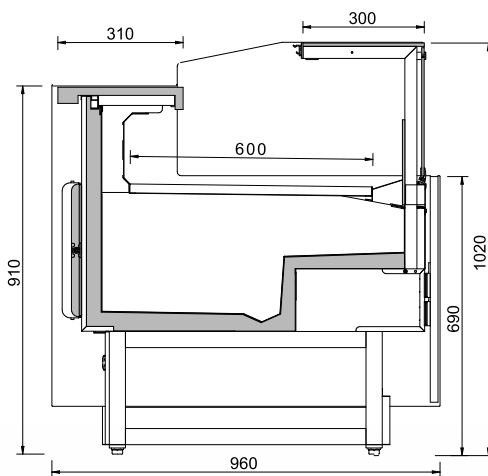

RAL		NO RAL	
Epoxi	Líquida/ Liquid/ Liquide	Epoxi	Líquida/ Liquid/ Liquide
[x unidad/x unit/x unité]		Consultar / Consultar / Consulter	
+10 días laborables / +10 work days / +10 jours ouvrés		Consultar / Consultar / Consulter	



VMG LG



Vitrina expositora frío ventilado con reserva, modular, para cafetería y pastelería / Refrigerated modular pastry display case with storage / Vitrine d'exposition froid ventilé avec réserve, modulaire, pour cafétéria et pâtisserie

MODELO MODELE MODÈLE					
Precio Price Prix					
Medidas/Measures/ Mesures [mm] Sin costados/Without sides/Sans joues	1365 x 960 x 1220 mm.	1750 x 960 x 1220 mm.	1365 x 960 x 1220 mm.	1180 x 960 x 1220 mm.	1365 x 960 x 1220 mm.
Temperatura Temperature [°C] Température	+4°C/+8°C				
Clase Climática Climatic class [°C] Classe climatique	3 / 25°C				
Tensión/Frecuencia Electrical data Tension électrique	230V/1ph/50Hz				
Controlador Controller Régulateur	Digital				
Material Material [EXT/INT] Matériel	Ext: acero plastificado / Plastified steel / Acier plastifié Plano exposición / Exhibition plan / Plan d'exposition: Acero plastif. negro / Black plastif. Stainless steel / Acier plastifié noir				
Aislamiento Isolation [mm] Isolation	40kg/m ³ / Free CFC's / Zero ODP-GWP				
Capacidad Capacity [L] Capacité	-				
Superficie exposición Surface exhibition [m ²] Surface d'exposition	0,9	1,2	1,1	0,8	0,9
Compresor Compressor [HP] Compresseur	1/2				
Estantes / Puertas Shelving / Doors Étagères / Portes	1				
Costados [2] Sides [2] [mm] Joues [2]	30 + 30				
Sistema de frío Cooling System Système de froid	Ventilado / Ventilated / Ventilé				
Desescarche Defrost Dégivrage	Automático / Automatic / Automatique				
Evaporación Evaporation Évaporation	Ventilado / Ventilated / Ventilé				
Potencia Power [W] Puissance	580	594	594	548	580
Potencia frig. Cooling capacity [W A -10°C] Puissance Frig.	-				
Consumo Consumption [kWh/ 24h] Consommation	8,3	8,5	8,5	7,9	8,3
Refrigerante Refrigerant Gaz	R290				
Opcional Optional Options	<p>Puertas correderas traseras Rear sliding doors Portes arrières coulissantes</p> <p>VMG 90 AARU PUEVMG90AACT VMG 90 ACRU PUEVMG90ACCT VMG 90 ARRU PUEVMG90ARCT VMG 45 AARU PUEVMG45AACT VMG 45 ACRU PUEVMG45ACCT</p>				

Laterales no incluidos en el precio
Side panels not included in price
Joues non incluses dans le prix

NEW

Series / Série **MAGNUS**

+Info: www.infrico.com

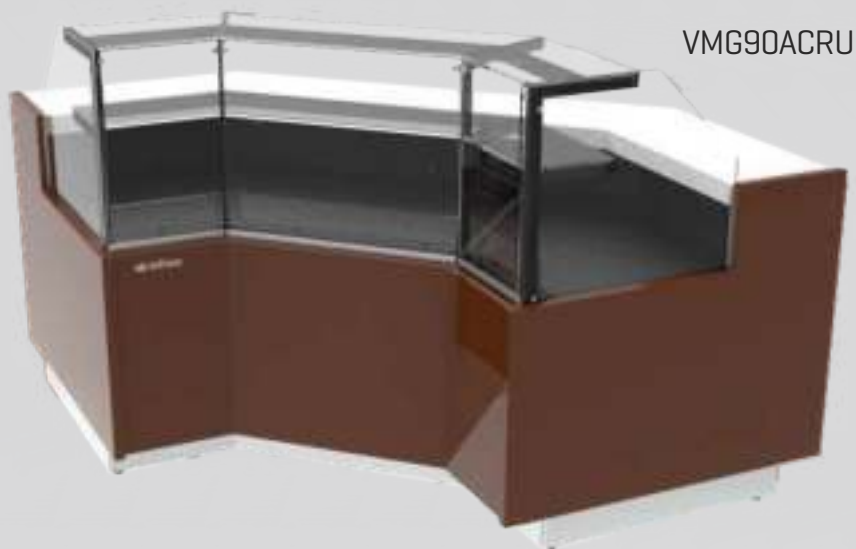

VMG90ACRU

Laterales / Sides / Joues

NO	
Izquierdo Left Gauche	Derecho Right Droite

Ext. Estándar / Standar / Standard

Ral 9016	Ral 1001	Ral 1018
Ral 2003	Ral 3003	Ral 3020
Ral 4007	Design 3504035	Ral 5015
Design 1107060	Ral 6002	Design 2108025
Ral 8017	Ral 9006	Ral 7016
Nogal-Walnut- Noyer	Wengué-Wenge- Wenge	Ral 9017

**Colores fuera de carta /
Colors outside of letter /
Couleurs spéciales, hors palette**

RAL		NO RAL	
Epoxi	Líquida/ Liquid/ Liquide	Epoxi	Líquida/ Liquid/ Liquide
		Consultar / Consulter / Consulter	
(x unidad/x unit/x unité)			
+10 días laborables / +10 work days / +10 jours ouvrés		Consultar / Consulter / Consulter	

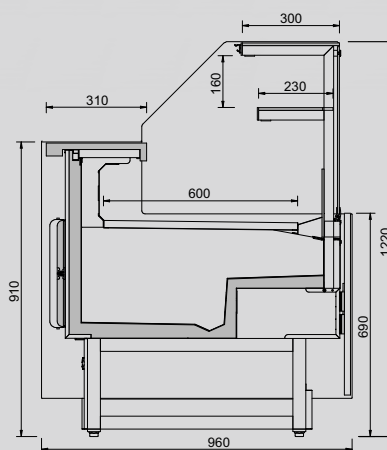







VMG



Vitrina expositora modular neutra (panera) /
Neutral modular display case /
Vitrine d'exposition modulaire neutre

Mueble caja /
Counter case /
Meuble caisse

MODELO MODELE MODÈLE	VITRINA / DISPLAY CASE / VITRINE		MUEBLE CAJA / COUNTER CASE / MEUBLE CAISSE			
	 VMG 9 P	 VMG 12 P	 VMG 90 AAM	 VMG 90 ACM	 VMG 45 AAM	 VMG 45 ACM
Precio Price Prix						
Medidas/Measures/ Mesures (mm) Sin costados/Without sides/Sans joues	938 x 960 x 1345 mm.	1250 x 960 x 1345 mm.	1365 x 960 x 1345 mm.	1750 x 960 x 1345 mm.	1180 x 960 x 920 mm.	1365 x 960 x 920 mm.
Temperatura Temperature (°C) Température	-					
Clase Climática Climatic class (°C) Classe climatique	3 / 25°C					
Tensión/Frecuencia Electrical data Tension électrique	-		230V/1ph/50Hz			
Controlador Controller Régulateur	-					
Material Matériel (EXT/INT)	Ext: acero plastificado / Plastified steel / Acier plastifié Plano exposición / Exhibition plan / Plan d'exposition: Acero plastif. negro / Black plastif. Stainless steel / Acier plastifié noir					
Aislamiento Isolation (mm)	40kg/m ³ / Free CFC's / Zero ODP-GWP					
Capacidad Capacity (L) Capacité	-					
Superficie exposición Surface exhibition (m ²) Surface d'exposition	0,6	0,8	-			
Compresor Compressor (HP) Compresseur	-		-			
Estantes Shelving Étagères	1		-			
Costados (2) Sides (2) (mm) Joues (2)	30 + 30					
Sistema de frío Cooling System Système de froid	-					
Desescarche Defrost Dégivrage	-					
Evaporación Evaporation Évaporation	-					
Potencia Power (W) Puissance	24	30	7	10	5	7
Potencia frig. Cooling capacity (W A -10°C) Puissance Frig.	-					
Consumo Consumption (kWh/ 24h) Consommation	0,4	0,5	0,1	0,2	0,1	0,2
Refrigerante Refrigerant Gaz	-					
Opcional Optional Options	-					

Series / Série **MAGNUS**

+Info: www.infrico.com

NEW

VMG12P



Laterales / Sides / Jous

Incluidos / Includes / Inclus

Ext. Estándar / Standar / Standard

Ral 9016	Ral 1001	Ral 1018
Ral 2003	Ral 3003	Ral 3020
Ral 4007	Design 3504035	Ral 5015
Design 1107060	Ral 6002	Design 2108025
Ral 8017	Ral 9006	Ral 7016
Nogal-Walnut-Noyer	Wengué-Wenge-Wenge	Ral 9017

Colores fuera de carta / Colors outside of letter / Couleurs spéciales, hors palette



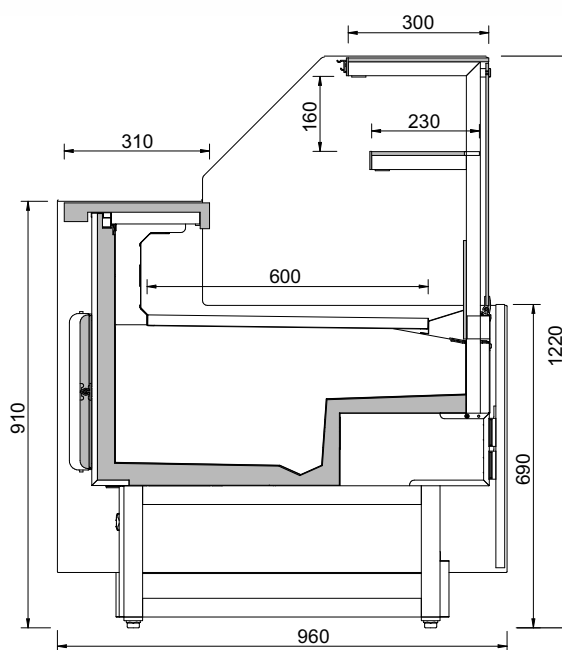

RAL		NO RAL	
Epoxi	Líquida/ Liquid/ Liquide	Epoxi	Líquida/ Liquid/ Liquide
[x unidad/x unit/x unité]		Consultar / Consulter / Consulter	
+10 días laborables / +10 work days / +10 jours ouvrés		Consultar / Consulter / Consulter	



VMG P

**Mueble caja /
Counter case /
Meuble caisse**

Serie / Series / Série **MAGNUS**

MODELO MODELE MODÈLE	 VMG 9 C	 VMG 12 M	 VMG 18 M	 VMG 12 MHD
Precio Price Prix				
Medidas/Measures/ Mesures [mm] Sin costados/Without sides/Sans joues	938 x 960 x 690 mm.	1250 x 960 x 690 mm.	1875 x 960 x 690 mm.	1250 x 960 x 736 mm.
Costados [2] Sides [2] Joues [2] [mm]	30 + 30			

VMG12MHD



+Info: www.infrico.com

NEW

VMG12M

Laterales / Sides / Jous

Incluidos / Includes / Inclus

Ext. Estándar / Standar / Standard

Ral 9016	Ral 1001	Ral 1018
Ral 2003	Ral 3003	Ral 3020
Ral 4007	Design 3504035	Ral 5015
Design 1107060	Ral 6002	Design 2108025
Ral 8017	Ral 9006	Ral 7016
Nogal-Walnut-Noyer	Wengué-Wenge-Wenge	Ral 9017

Colores fuera de carta / Colors outside of letter / Couleurs spéciales, hors palette

RAL		NO RAL	
Epoxi	Líquida/Liquid/Liquide	Epoxi	Líquida/Liquid/Liquide
[x unidad/x unit/x unité]		Consultar / Consulter / Consulter	
+10 días laborables / +10 work days / +10 jours ouvrés		Consultar / Consulter / Consulter	



Vitrina expositora helados / Gelato display case / Vitrine d'exposition pour glace

MODELO
MODELE
MODÈLE



VCB 12 UH



VCB 15 UH



VCB 18 UH

Precio Price Prix			
Medidas/Measures/ Mesures [mm] Sin costados/Without sides/Sans joues	1250 x 1052 x 1200 mm.	1562 x 1052 x 1200 mm.	1875 x 1052 x 1200 mm.
Temperatura Temperature [°C] Température	-15°C/-18°C		
Clase Climática Climatic class [°C] Classe climatique	7 / 35°C		
Tensión/Frecuencia Electrical data Tension électrique	230V/1ph/50Hz		
Controlador Controller Régulateur	Digital		
Material Material [EXT/INT] Matériel	Acero plastificado / Plastified galvanised steel / Acier galvanisé plastifié Plano exposición / Exhibition plan / Plan d'exposition: Inox Aisi 304		
Aislamiento Isolation [mm] Isolation	40kg/m ³ / Free CFC's / Zero ODP-GWP		
Capacidad Capacity [L] Capacité	182	228	274
Superficie exposición Surface exhibition [m ²] Surface d'exposition	0,96	1,20	1,49
Compresor Compressor [HP] Compresseur	1 1/4	1 1/4 + 1	1 1/4 + 1
Bandejas Shelving Bacs	8 / 14	10 / 16	14 / 20
Costados [2] Sides [2] Joues [2] [mm]	30 +30		
Sistema de frío Cooling System Système de froid	Ventilado / Ventilated / Ventilé		
Desescarche Defrost Dégivrage	Gas caliente / Hot gas / Gaz chaud		
Evaporación Evaporation Évaporation	Ventilado / Ventilated / Ventilé		
Potencia Power [W] Puissance	1250	1570	1640
Potencia frig. Cooling capacity [W A -10°C] Puissance Frig.	-		
Consumo Consumption [kWh/ 24h] Consommation	19,7	28,9	30,8
Refrigerante Refrigerant Gaz	R-290		
Opcional Optional Options	230v/1ph/60 Hz		
	Combinación de bandejas / Tray combinations / Combinaisons de bacs [501X36] x 8uds. [501X32] x 14uds. [501X36] x 10uds. [501X32] x 16uds. [501X36] x 14uds. [501X32] x 20uds.		
	Puertas correderas traseras / Rear sliding doors / Portes arrière coulissantes PUEVCB12CT	Puertas correderas traseras / Rear sliding doors / Portes arrière coulissantes PUEVCB15CT	Puertas correderas traseras / Rear sliding doors / Portes arrière coulissantes PUEVCB18CT

Vitrina expositora helados / Gelato display case / Vitrine d'exposition pour glace

MODELO
MODELE
MODÈLE



VAR 12 H



VAR 15 H



VAR 18 H

Precio Price Prix			
Medidas/Measures/ Mesures [mm] Sin costados/Without sides/Sans joues	1250 x 1145 x 1320 mm.	1562 x 1145 x 1320 mm.	1875 x 1145 x 1320 mm.
Temperatura Temperature [°C] Température	-15°C/-18°C		
Clase Climática Climatic class [°C] Classe climatique	7 / 35°C		
Tensión/Frecuencia Electrical data Tension électrique	230V/1ph/50Hz		
Controlador Controller Régulateur	Digital		
Material Matériel [EXT/INT]	Acero plastificado / Plastified galvanised steel / Acier galvanisé plastifié Plano exposición / Exhibition plan / Plan d'exposition: Inox Aisi 304		
Aislamiento Isolation [mm]	40kg/m ³ / Free CFC's / Zero ODP-GWP		
Capacidad Capacity [L]	182	228	274
Superficie exposición Surface exhibition [m ²] Surface d'exposition	0,96	1,26	1,44
Compresor Compressor [HP]	1 1/4	1 1/4 + 1	1 1/4 + 1
Bandejas Shelving Bacs	8 / 14	10 / 16	14 / 20
Costados [2] Sides [2] [mm] Joues [2]	30 +30		
Sistema de frío Cooling System Système de froid	Ventilado / Ventilated / Ventilé		
Desescarche Defrost Dégivrage	Gas caliente / Hot gas / Gaz chaud		
Evaporación Evaporation Évaporation	Ventilado / Ventilated / Ventilé		
Potencia Power [W] Puissance	1020	1536	1640
Potencia frig. Cooling capacity [W A -10°C] Puissance Frig.	-		
Consumo Consumption [kWh/ 24h]	19,7	28,9	30,8
Refrigerante Refrigerant Gaz	R-290		
Opcional Optional Options	230v/1ph/60 Hz Combinación de bandejas Tray combinations Combinaisons de bacs [501X36] x 8uds. [501X32] x 14uds. [501X36] x 10uds. [501X32] x 16uds. [501X36] x 14uds. [501X32] x 20uds.		

Serie / Series / Série **ARIES**

+Info: www.infrico.com

VAR15H

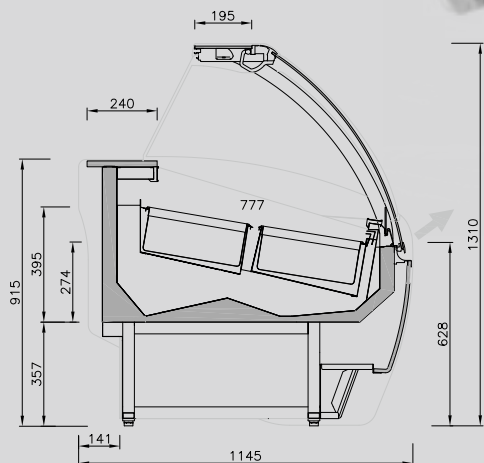

VAR15H



Cristal elevable
Lift-up glass
Vitre relevable



Laterales / Sides / Joues

Incluidos / Includes / Inclus

Ext. Estándar / Standar / Standard

Ral 9016	Ral 1001	Ral 1018
Ral 2003	Ral 3003	Ral 3020
Ral 4007	Design 3504035	Ral 5015
Design 1107060	Ral 6002	Design 2108025
Ral 8017	Ral 9006	Ral 7016
Ral 9017		



8 [501X36] x 8 uds. 14 [501X32] x 14 uds.



10 [501X36] x 10 uds. 16 [501X32] x 16 uds.



14 [501X36] x 14 uds. 20 [501X32] x 20 uds.

Combinación de bandejas
Combination of trays
Combinaison de bacs



Cortina nocturna
Night curtain
Rideau de nuit







Colores fuera de carta /
Colors outside of letter /
Couleurs spéciales, hors palette

RAL		NO RAL	
Epoxi	Líquida/ Liquid/ Liquide	Epoxi	Líquida/ Liquid/ Liquide
[x unidad/x unit/x unité]		Consultar / Consultar / Consultar	
+10 días laborables / +10 work days / +10 jours ouvrés		Consultar / Consultar / Consultar	

Bandeja evaporativa extraíble
Removable evaporation tray
Bac d'évaporation extractable



Vitrina estática expositora helados / Gelato static display case / Vitrine statique d'exposition pour glace

MODELO MODELE MODÈLE				
Precio Price Prix				
Medidas Measures Mesures (mm)	1310 x 920 x 1350 mm.	1622 x 920 x 1350 mm.	1310 x 670 x 1350 mm.	1622 x 670 x 1350 mm.
Temperatura Temperature Température (°C)	-15°C/-18°C			
Clase Climática Climatic class Classe climatique (°C)	7 / 35°C			
Tensión/Frecuencia Electrical data Tension électrique	230V/1ph/50Hz			
Controlador Controller Régulateur	Digital			
Material Material Matériel (EXT/INT)	Acero plastificado / Plastified galvanised steel / Acier galvanisé plastifié Plano exposición / Exhibition plan / Plan d'exposition: Inox Aisi 304			
Aislamiento Isolation Isolation (mm)	40kg/m ³ / Free CFC's / Zero ODP-GWP			
Capacidad Capacity Capacité (L)	289	361	210	263
Superficie exposición Surface exhibition Surface d'exposition (m ²)	0,94	1,41	0,50	0,63
Compresor Compressor Compresseur (HP)	1		3/4	
Bandejas Shelving Bacs	10+10	13+13	7+7	9+9
Costados [2] Sides [2] Joues [2] (mm)	30 +30			
Sistema de frío Cooling System Système de froid	Estático / Static / Statique			
Desescarche Defrost Dégivrage	Gas caliente / Hot gas / Gaz chaud			
Evaporación Evaporation Évaporation	Ventilado / Ventilated / Ventilé			
Potencia Power Puissance (W)	480	484	432	436
Potencia frig. Cooling capacity Puissance Frig. (W A -10°C)	-			
Consumo Consumption Consommation (kWh/ 24h)	11,5	13,6	9,9	11,5
Refrigerante Refrigerant Gaz	R-290			
	Ruedas de serie Tray combinations Combinaisons de bacs			
Opcional Optional Options	Combinación de bandejas Tray combinations Combinaisons de bacs			
	VBZ12 [501X32] x 10 uds. VBZ15 [501X32] x 13 uds.		VBZ12S [501X32] x 7 uds. VBZ15S [501X32] x 9 uds.	

Serie / Series / Série **IBIZA**

+Info: www.infrico.com

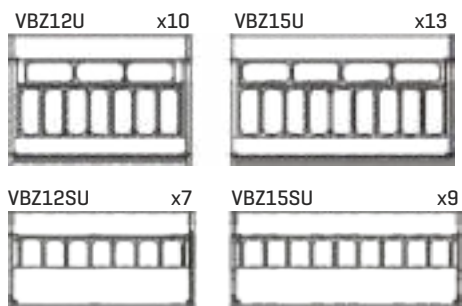

VBZ12U

Laterales / Sides / Joues

Incluidos / Includes / Inclus

Ext. Estándar / Standar / Standard

Ral 9016	Ral 1001	Ral 1018
Ral 2003	Ral 3003	Ral 3020
Ral 4007	Design 3504035	Ral 5015
Design 1107060	Ral 6002	Design 2108025
Ral 8017	Ral 9006	Ral 7016
Ral 9017		

Colores fuera de carta / Colors outside of letter / Couleurs spéciales, hors palette

RAL		NO RAL	
Epoxi	Líquida/ Liquid/ Liquide	Epoxi	Líquida/ Liquid/ Liquide
[x unidad/x unit/x unité]		Consultar / Consultar / Consultar	
+10 días laborables / +10 work days / +10 jours ouvrés		Consultar / Consultar / Consultar	

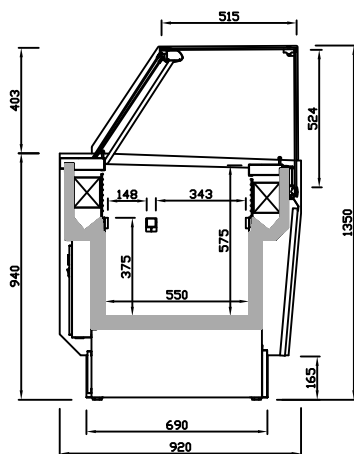

VBZ U



VBZ15U



12. Hostelería

Horeca Equipment / Négoce





12. Hostelería

Horeca Equipment / Négoce

<small>Serie / Series / Série</small>		
FHC ICE CUBE	Fabricador de hielo cubito macizo Ice maker solid cube / Machines à glaçons solides	498
<small>Serie / Series / Série</small>		
FHCM/SPLIT ICE CUBE	Fabricador de hielo cubito macizo Ice maker solid cube / Machines à glaçons solides	499
<small>Serie / Series / Série</small>		
FHC B-CUBE	Fabricador de hielo cubito macizo cuadrado Ice maker square solid cube / Machines à glaçons solides carrés	500
<small>Serie / Series / Série</small>		
IMF	Fabricador de hielo hueco Hollow ice maker / Machines à glaçons creux	501
<small>Serie / Series / Série</small>		
NEW	FHTB/ FHTBM PEBBLES	Fabricador de hielo troceado Cubed ice maker / Machines à glaçons en morceau
<small>Serie / Series / Série</small>		
FHT/FHTM ICE FLAKES	Fabricador de hielo troceado Cubed ice maker / Machines à glaçons en morceau	504
<small>Serie / Series / Série</small>		
FHTM/SPLIT ICE FLAKES	Fabricador de hielo troceado Cubed ice maker / Machines à glaçons en morceau	505
<small>Serie / Series / Série</small>		
FHES COLD FLAKES	Fabricador de hielo en escama Flake ice maker / Machines à glaçons à pailletes	506
<small>Serie / Series / Série</small>		
FHES/SPLIT COLD FLAKES	Fabricador de hielo en escama Flake ice maker / Machines à glaçons à pailletes	507
<small>Serie / Series / Série</small>		
DPE/DI	Almacén fabricante de hielo Ice maker storage / Stockage pour machines à glaçons	508
<small>Serie / Series / Série</small>		
ROLLER BIN/ DOBLE ROLLER BIN	Almacén de hielo Ice storage / Stockage pour glaçons	509

+Info: www.infrico.com

Serie / Series / Série

ELECTROMECÁNICA
ELECTROMECHANICAL
ÉLECTROMÉCANIQUE**Lavavasos y lavaplatos**
Glasswasher, dishwasher and hood dishwasher / Lave-vaisselle**510 - 513**

Serie / Series / Série

ELECTRÓNICA
ELECTRONIC
ÉLECTRONIQUE**Lavavasos y lavaplatos**
Glasswasher, dishwasher and hood dishwasher / Lave-vaisselle**514 - 517**

Serie / Series / Série

Accesorios lavavasos y lavaplatos cúpula
Dishwasher accesories / Accessoires lave-vaisselle**518 - 519**

Serie / Series / Série

LP**Lavautensilios y lavaperolas**
Dishwasher / Lave-ustensiles**520 - 521**

Serie / Series / Série

TA**Túneles de lavado y arrastre**
Rack conveyor dishwasher / Tunnels de lavage**522 - 523**

Serie / Series / Série

Accesorios Túnel de lavado
Rack conveyor dishwasher accesories / Accessoires tunnels de lavage**524 - 525**

Serie / Series / Série

HF**Congelador tapa abatible - puerta corredera**
Lid chest freezer - Sliding doors conservator
Congélateur avec couvercle battant - coulissant**526 - 527**

Serie / Series / Série

NEW**PRO****Congelador tapa abatible -60°**
Lid chest freezer -60°
Congélateur avec couvercle battant -60°**528 - 529**

Serie / Series / Série

IL / CHE**Conservadora expositora puerta cristal**
Horizontal freezer with glass lid / Conservateur panoramique pour surgelés**530 - 531**

12. Hostelería

Horeca Equipment / Négoce

Serie / Series / Série		
EHC EHC D EHC R	Conservadora expositora puerta cristal curvada Conservative of curved glass crystal door Conservateur panoramique pour surgelés	532 - 533
Serie / Series / Série		
MINI ARMARIO	Armario de refrigeración y congelación Chillers and freezers / Congélateur vertical	534 - 535
Serie / Series / Série		
CV	Congelador vertical Vertical freezer / Congélateur vertical	536 - 537
Serie / Series / Série		
LO LO SOFT AIR LO NO-FROST	Armario expositor heladería y pastelería Exhibiting cupboard for ice-cream and pastry Armoire d'exposition pour la glace et la pâtisserie	538 - 543
Serie / Series / Série		
VITRA VITRA SOFT AIR VITRA NO-FROST	Armario expositor heladería y pastelería Exhibiting cupboard for ice-cream and pastry Armoire d'exposition pour la glace et la pâtisserie	544 - 551
Serie / Series / Série		
NEW	HDC	Murales calientes / Hot display cabinet / Murale d'exposition chaude
Serie / Series / Série		
MICROONDAS HM	Horno microondas profesional Professional microwave oven / Four micro-ondes professionnel	554 - 555
Serie / Series / Série		
FERMENTADOR	Armario caliente fermentador Fermentation ovens / Armoire de fermentation	556 - 557
HORNO ELÉCTRICO HE	Horno eléctrico para panadería Electric bakery oven / Fours pour la boulangerie	
Serie / Series / Série		
VACE	Envasadora al vacío de aspiración externa External aspiration vacuum packaging machine Machine sous vide à aspiration extérieure	558

+Info: www.infrico.com

Serie / Series / Série		
TSB	Máquina termoselladora Thermosealer machine / Machines thermo-soudeuses	559
Serie / Series / Série		
VACT	Envasadora al vacío por tiempo Time vacuum packaging machine / Machines sous vide pour temps	560
Serie / Series / Série		
VACS	Envasadora al vacío por sensor Sensor vacuum packaging machine / Machines sous vide pour senseur	561
Serie / Series / Série		
PG PG/PE	Plancha a gas - Plancha eléctrica Gas - Electrical griddles / Plancha à gaz - électrique	562 - 563
Serie / Series / Série		
GR	Grill eléctrico Electrical grill / Grill panini électrique	564
Serie / Series / Série		
FR	Freidora eléctrica Electrical fryer / Friteuse électrique	565
Serie / Series / Série		
NEW SE / SEUF / SG	Salamandra / Salamander / Salamandre	566-567
Serie / Series / Série		
TTV-TTH / T	Tostador de túnel eléctrico - Tostador eléctrico Electric tunnel toaster-Electric toaster / Toaster à tunnel électrique-Toaster électrique	568 - 569
Serie / Series / Série		
TL	Termo de leche Milk urns / Thermo de lait	570
Serie / Series / Série		
CS CSCEV	Cortadora de fiambre Sharpening slicers / Trancheuse professionnelle	571





FHC20AHC/WHC



FHC45AHC/WHC



FHC80AHC/WHC



Serie C: cubito macizo con almacén
C Series: full cube with storage
Séries C: bloc glaçon avec stockage



13 gr
30x26x29 mm

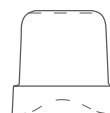

33 gr
40x35x39 mm

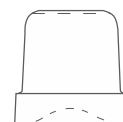

42 gr
42x39x43 mm



60 gr
43x45x51 mm

MODELO/MODELE/MODÈLE	FHC20AHC FHC20WHC	FHC30AHC FHC30WHC	FHC35AHC FHC35WHC	FHC40AHC FHC40WHC	FHC45AHC FHC45WHC	FHC65AHC FHC65WHC	FHC80AHC FHC80WHC	FHC90AHC FHC90WHC	FHC130AHC	FHC155AHC
Precio Price Prix										
Medidas Measures [mm] Mesures	↔ 355 ↗ 404 ↓ 590	↔ 390 ↗ 460 ↓ 690	↔ 500 ↗ 580 ↓ 690	↔ 500 ↗ 580 ↓ 690	↔ 500 ↗ 580 ↓ 800	↔ 735 ↗ 603 ↓ 850	↔ 738 ↗ 600 ↓ 920	↔ 738 ↗ 600 ↓ 1020	↔ 840 ↗ 740 ↓ 1075	↔ 840 ↗ 740 ↓ 1075
Tensión/Frecuencia Electrical data [V/Hz] Tension électrique	220V-240V/50Hz									
Material Material Matériel	AISI 304									
Condensación Condensation Condenseur	Aire / Agua Air / Water Air / Eau	Aire / Agua Air / Water Air / Eau	Aire / Agua Air / Water Air / Eau	Aire / Agua Air / Water Air / Eau	Aire / Agua Air / Water Air / Eau	Aire / Agua Air / Water Air / Eau	Aire / Agua Air / Water Air / Eau	Aire / Agua Air / Water Air / Eau	Aire / Agua Air / Water Air / Eau	Aire / Agua Air / Water Air / Eau
Cubito Cubes Glaçons [gr]	13	42	42	42	42	42	42	42	42	42
Producción Production Compresseur [Kg/24h]	21	29	38	42	48	72	80	95	134	152
Almacén Warehouse Stockage [Kg.]	4	9	16	16	25	40	40	55	65	65
Potencia Power Puissance [W]	260	320	340	340	450	590	700	890	1250	1260
Refrigerante Refrigerant Gaz	R290									
Opcional Optional Options	Gas refrigerante HFC / Refrigerant gas HFC / Gaz réfrigérant HFC [Mod. FHC 130 AHC, FHC 155 AHC] Cubito 60gr [consultar] / Cube 60gr [consult] / Glaçon 60gr [consulter]									

Producción en condiciones óptimas: temperatura ambiente 21°C, temperatura agua 15°C.

Production in optimum conditions: room temperature 21°C, water temperature 15°C.

Production dans des conditions optimales: température ambiante 21°C, température de l'eau 15°C.

**Fabricador de hielo /
Ice maker /
Machines à glaçons**

Serie / Series / Série FHCM/SPLIT Ice Cube



FHCM300A/W



FHCM150AHC/W



Serie CM-Modular: cubito macizo sin almacén
CM-Modular Series: full cube without storage
Série CM-Modulaire: glaçon entier sans stockage

Serie CM-Split: cubito macizo sin unidad condensadora
CM-Split Series: full cube without condensed unit
Série CM-Split: glaçon entier sans unité de condensation

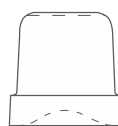

42 gr
42x39x43 mm

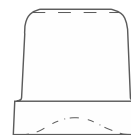

60 gr
43x45x51 mm

MODELO/MODELE/MODÈLE	FHCM150AHC FHCM150W	FHCM300A FHCM300W	FHCM300S SPLIT
Precio Price Prix			
Medidas Measures (mm) Mesures	862 555 720	1250 580 848	990 585 850
Tensión/Frecuencia Electrical data (V/Hz) Tension électrique	220V-240V/50Hz		
Material Material Matériel	AISI 304		
Condensación Condensation Condenseur	Aire / Agua Air / Water Air / Eau	Aire / Agua Air / Water Air / Eau	Sin unidad condensadora Without condensed unit Sans unité de condensation
Cubito Cubes Glaçons (gr)	42	42	42
Producción Production (Kg/24h) Compresseur	155	300	300
Depósito compatible Compatible deposit Dépôt compatible	DI200 / DPE240 / DI350	DI350	DI350
Potencia Power (W) Puissance	1260/1400	2600	200
Refrigerante Refrigerant Gaz	R290 / HFC	HFC	HFC
Opcional Optional Options	[FHCM150] Gas refrigerante HFC / Refrigerant gas HFC / Gaz réfrigérant HFC Cubito 60Gr [consultar] / Cube 60gr [consult] / Glaçon 60Gr [consulter]		

Producción en condiciones óptimas: temperatura ambiente 21°C, temperatura agua 15°C.
Production in optimum conditions: room temperature 21°C, water temperature 15°C.
Production dans des conditions optimales: température ambiante 21°C, température de l'eau 15°C.



FHC30BQAHC/WHC



FHC45BQAHC/WHC



FHC90BQAHC/WHC



Serie B-Qube: cubito macizo cuadrado
B-Qube Series: Solid square cube
Séries B-Qube: bloc glaçon carré

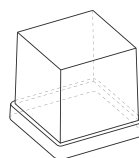

23 gr
32.5x31.5 mm

MODELO/MODELE/MODÈLE	FHC30BQAHC FHC30BQWHC	FHC35BQAHC FHC35BQWHC	FHC40BQAHC FHC40BQWHC	FHC45BQAHC FHC45BQWHC	FHC65BQAHC FHC65BQWHC	FHC90BQAHC FHC90BQWHC
Precio Price Prix						
Medidas Measures [mm] Mesures	390 460 690	497 592 687	497 592 687	500 580 800	738 600 920	738 600 1020
	-	Medidas sin patas / Measurements without legs / Dimensions sans pieds Patas regulables / Adjustable legs / Pieds réglables (110-150mm)				
Tensión/Frecuencia Electrical data [V/Hz] Tension électrique	220V-240V/50Hz					
Material Material Matériel	AISI 304					
Condensación Condensation Condenseur	Aire / Agua Air / Water Air / Eau					
Cubito Cubes [gr] Glaçons	23					
Producción Production [Kg/24h] Compresseur	29	38	42	48	72	90
Almacén Warehouse [Kg.] Stockage	9	16	16	25	40	55
Potencia Power [W] Puissance	320	340	455	450	620	890
Refrigerante Refrigerant Gaz	R290					
Opcional Optional Options	-					

Producción en condiciones óptimas: temperatura ambiente 21°C, temperatura agua 15°C.

Production in optimum conditions: room temperature 21°C, water temperature 15°C.

Production dans des conditions optimales: température ambiante 21°C, température de l'eau 15°C.

Fabricador de hielo hueco /
Hollow ice maker /
Machines à glaçons creux

Serie / Series / Série IMF



IMF28AHC/IMF28WHC



IMF35AHC/IMF35WHC



IMF58AHC/IMF58WHC



Serie IMF: cubito hueco
IMF Series: hollow cube
Séries IMF: glaçon creux

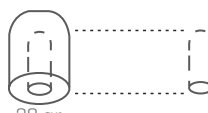

20 gr
 29 Ø x 45 mm 12 Ø x 36,5 mm

MODELO/MODELE/MODÈLE	IMF26AHC IMF26WHC	IMF28AHC IMF28WHC	IMF35AHC IMF35WHC	IMF58AHC IMF58WHC	IMF80AHC IMF80WHC
Precio Price Prix					
Medidas Measures Mesures (mm)	385 468 607	385 468 687	495 580 687	495 580 797	735 596 907
	- Medidas sin patas / Measurements without legs / Dimensions sans pieds Patatas regulables / Adjustable legs / Pieds réglables [110-150mm]				
Tensión/Frecuencia Electrical data (V/Hz) Tension électrique	220V-240V/50Hz				
Material Material Matériel	AISI 304				
Condensación Condensation Condenseur	Aire / Agua Air / Water Air / Eau				
Cubito Cubes Glaçons (gr)	20				
Producción Production Compresseur (Kg/24h)	22	22	38	46	85
Almacén Warehouse Stockage (Kg.)	4	8	15	20	30
Potencia Power Puissance (W)	300	300	275	315	500
Refrigerante Refrigerant Gaz	R290				
Opcional Optional Options	Gas refrigerante HFC / Refrigerant gas HFC / Gaz réfrigérant HFC				

Producción en condiciones óptimas: temperatura ambiente 21°C, temperatura agua 15°C.
Production in optimum conditions: room temperature 21°C, water temperature 15°C.
Production dans des conditions optimales: température ambiante 21°C, température de l'eau 15°C.

Los datos técnicos están sujetos a posibles variaciones que serán actualizadas periódicamente en las fichas técnicas del producto, disponibles en la web /
 The technical data are subject to possible variations that will be updated periodically in the technical data sheets of the product, which are available on the website /
 Les données techniques peuvent varier et seront actualisées dans les fiches techniques du produit, disponibles sur le site web.

Fabricador de hielo /
Ice maker /
Machines à glaçons



FHTB90AHC/WHC



FHTB57AHC/WHC



HIELO TROCEADO PEBBLES / PEBBLES ICE / GLACE EN MORCEAU PEBBLES

Serie TB: hielo troceado con almacén

TB Series: pebbles ice with storage

Séries TB: ice en morceau avec storage

Serie TBM-Modular: hielo troceado sin almacén

TBM-Modular Series: pebbles ice without storage

Série TBM-Modular: Ice en morceau sans storage

MODELO/MODELE/MODÈLE	FHTB57AHC FHTB57WHC	FHTB90AHC FHTB90WHC	FHTB93AHC FHTB93WHC	FHTB142AHC FHTB142WHC	FHTB146AHC FHTB146WHC	FHTBM140AHC FHTBM140WHC	FHTBM250AHC FHTBM250WHC	FHTBM450AHC FHTBM450WHC	
Precio Price Prix									
Medidas Measures (mm) Mesures	450 620 680	500 660 690	500 660 800	738 690 851,5	738 690 1020	560 569 600	560 569 600	560 569 600	
	Medidas sin patas / Measurements without legs / Dimensions sans pieds Patatas regulables / Adjustable legs / Pieds réglables (110-150mm)								
Tensión/Frecuencia Electrical data [V/Hz] Tension électrique	220V-240V/50Hz								
Material Material Matériel	AISI 304								
Condensación Condensation Condenseur	Aire / Agua Air / Water Air / Eau								
Producción Production [Kg/24h] Compresseur	57	90	90	142	146	130	245	375	
Almacén Warehouse [Kg.] Stockage	10	20	30	40	50	-			
Depósito compatible Compatible deposit Dépôt compatible	-					DPE240/ DI110 DI200/RBI100	DPE240/DI110/ DI200/ DI350/ DI350/RBI100 DRBI100	DPE240/DI110/DI200/ DI350/DI550/RBI100/ DRBI100/DRBI500/ DRBI1200	
Potencia Power [W] Puissance	410	440	440	720	720	700	1050	1415	
Refrigerante Refrigerant Gaz	R290								
Opcional Optional Options	Gas refrigerante HFC / Refrigerant gas HFC / Gaz réfrigérant HFC								

NEW

Series / Série **FHTB / FHTBM PEBBLES**

+Info: www.infrico.com



FHTB142AHC/WHC



FHTB146AHC/WHC



FHTBM450AHC/TM450AHC

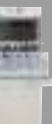



FHT155AHC/WHC

Serie T: hielo troceado con almacén
T Series: cubed ice with storage
Séries T: ice en morceau avec storage



FHTM160AHC/WHC
FHTM280AHC/WHC
FHTM510AHC/WHC



FHTM1000A/W

Serie TM-Modular: hielo troceado sin almacén
TM-Modular Series: cubed ice without storage
Série TM-Modular: Ice en morceau sans storage



HIELO TROCEADO / CUBED ICE / GLACE EN MORCEAU

MODELO/MODELE/MODÈLE	FHT60AHC FHT60WHC	FHT90AHC FHT90WHC	FHT155AHC FHT155WHC	FHTM160AHC FHTM160WHC	FHTM280AHC FHTM280WHC	FHTM510AHC FHTM510WHC	FHTM1000A/W
Precio Price Prix							
Medidas Measures Mesures (mm)	450 620 680	500 660 800	738 690 1020	560 569 600	560 569 695	560 569 695	934 684 700
	-	Medidas sin patas / Measurements without legs / Dimensions sans pieds Patatas regulables / Adjustable legs / Pieds réglables (110-150mm)		-			
Tensión/Frecuencia Electrical data (V/Hz) Tension électrique	220V-240V/50Hz						400-415V/3N/50Hz
Material Material Matériel	AISI 304						
Condensación Condensation Condenseur	Aire / Agua Air / Water Air / Eau						
Producción Production (Kg/24h) Compresseur	67	113	153	157	280	435	1000
Almacén Warehouse (Kg.) Stockage	9	30	55	-			
Depósito compatible Compatible deposit Dépôt compatible	-			DPE240/ DI110 DI200/RBI100	DPE240/DI110/ DI200/ DI350/ DI550/RBI100 DRBI100	DPE240/DI110/ DI200/ DI350/ DI550/RBI100 DRBI100/DRBI500	DI550/ DRBI500
Potencia Power (W) Puissance	400	470	700	830	1100	1400	3200
Refrigerante Refrigerant Gaz	R290						HFC
Opcional Optional Options	Gas refrigerante HFC / Refrigerant gas HFC / Gaz réfrigérant HFC						

Producción en condiciones óptimas: temperatura ambiente 21°C, temperatura agua 15°C.

Production in optimum conditions: room temperature 21°C, water temperature 15°C.

Production dans des conditions optimales: température ambiante 21°C, température de l'eau 15°C.

Fabricador de hielo /
Ice maker /
Machines à glaçons

Serie / Series / Série FHTM/SPLIT Ice Flakes



HIELO TROCEADO
CUBED ICE
GLACE EN MORCEAU

Serie SPLIT: hielo troceado sin unidad condensadora
SPLIT Series: ice divided without condensed unit
Séries SPLIT: glace en morceaux sans unité de condensation



FHTM1000S SPLIT

MODELO/MODELE/MODÈLE	FHTM510S SPLIT	FHTM1000S SPLIT
Precio Price Prix		
Medidas Measures [mm] Mesures	560 569 695	765 600 695
Tensión/Frecuencia Electrical data [V/Hz] Tension électrique	220V-240V/50Hz	
Material Material Matériel	AISI 304	
Condensación Condensation Condenseur	Sin unidad condensadora Without condensed unit Sans unité de condensation	
Producción Production [Kg/24h] Compresseur	510	1000
Depósito compatible Compatible deposit Dépôt compatible	DPE240 / DI200 / DI350 / DI550 RBI100 / DRBI100 / DRBI500	DI550 / DRBI500
Potencia Power [W] Puissance	175	350
Potencia frigorífica Refrigerating Power [W -18°C] Puissance frigorifique	2300 [evap.temp.-18°C]	4600 [evap.temp.-18°C]
Refrigerante Refrigerant Gaz	HFC	
Opcional Optional Options	 Modelos Split para gas refrigerante R744 [CO2] (FHT700SC02 [720 kg], FHTM1400SC02 [1400 kg] Split models for refrigerant R744 [CO2] (FHT700SC02 [720kg], FHTM1400SC02 [1400kg]) Modèles split pour gaz R744 [CO2] (FHT700SC02 [720kg], FHTM1400SC02 [1400kg])	

Producción en condiciones óptimas: temperatura ambiente 21°C, temperatura agua 15°C.
Production in optimum conditions: room temperature 21°C, water temperature 15°C.
Production dans des conditions optimales: température ambiante 21°C, température de l'eau 15°C.



FHESM400A/W



FHESM2200A



FHESM 5000A

Serie ES-Modular: hielo en escama plana sin almacén
ES-Modular Series: Flat flake ice without storage
Séries ES-Modular: ice à pailletes sans storage



HIELO EN ESCAMA
FLAKE ICE
GLACE À PAILLETES

MODELO/MODELE/MODÈLE	FHESM250A FHESM250W	FHESM400A FHESM400W	FHESM600A FHESM600W	FHESM900A FHESM900W	FHESM1500A FHESM1500W	FHESM2200A -	FHESM5000A -
Precio Price Prix							
Medidas Measures [mm] Mesures	870 550 600	900 588 705	900 588 705	1107 700 880	1107 700 970	1062 832 1423	1270 1400 1620
Tensión/Frecuencia Electrical data [V/Hz] Tension électrique	220V-240V/50Hz			400V-415V//3N/50Hz			
Material Material Matériel	AISI 304						
Condensación Condensation Condenseur	Aire / Agua Air / Water Air / Eau					Aire Air Air	
Producción Production [Kg/24h] Compresseur	250	400	620	900	1500	2300	5000
Almacén Warehouse Stockage	-						
Depósito compatible Compatible deposit Dépôt compatible	DI200 DI350	DI350 DI550 DRBI100	DI350 DI550 DRBI100/DRBI500	DI550 DRBI500	DI550 DRBI500	-	
Potencia Power [W] Puissance	1700	2100	3000	4600	6000	7000	16000
Refrigerante Refrigerant Gaz	HFC						
Opcional Optional Options	-						

Producción en condiciones óptimas: temperatura ambiente 21°C, temperatura agua 15°C.

Production in optimum conditions: room temperature 21°C, water temperature 15°C.

Production dans des conditions optimales: température ambiante 21°C, température de l'eau 15°C.

Fabricador de hielo /
Ice maker /
Machines à glaçons

Serie / Series / Série FHESM/SPLIT Cold Flakes



FHESM5000S SPLIT



FHESM400S a 2200S SPLIT

Serie ES-SPLIT: hielo en escama plana sin unidad condensadora
ES-SPLIT Series: Flat flake ice without condensed unit
Séries ES-SPLIT: ice à pailletes sans unité de condensation



HIELO EN ESCAMA
FLAKE ICE
GLACE À PAILLETES

MODELO/MODELE/MODÈLE	FHESM400S SPLIT	FHESM600S SPLIT	FHESM900S SPLIT	FHESM1500S SPLIT	FHESM2200S SPLIT	FHESM5000S SPLIT
Precio Price Prix						
Medidas Measures [mm] Mesures	495 588 705	495 588 705	604 700 880	604 700 970	736 832 1075	1270 1015 1076
Tensión/Frecuencia Electrical data [V/Hz] Tension électrique	220V-240V/50Hz				400V-415V//3N/50Hz	
Material Material Matériel	AISI 304					
Condensación Condensation Condenseur	Sin unidad condensadora Without condensed unit Sans unité de condensation					
Producción Production [Kg/24h] Compresseur	400	620	900	1500	2300	5000
Depósito compatible Compatible deposit Dépôt compatible	DI350 / DI550 DRBI100	DI350 / DI550 DRBI100 / DRBI500	DI550 / DRBI500	DI550 / DRBI500	-	-
Potencia Power [W] Puissance	180					360
Potencia frigorífica Refrigerating Power [W -18°C] Puissance frigorifique	2200W [evap.temp. -23°C]	3500W [evap.temp. -22°C]	5000W [evap.temp. -23°C]	8550W [evap.temp. -24°C]	12000W [evap.temp. -27°C]	25000W [evap.temp. -27°C]
Refrigerante Refrigerant Gaz	HFC					
Opcional Optional Options	 Modelos Split para gas refrigerante R744 [CO2] (FHESM600SCO2 [620 kg], FHESM900SCO2 [1040kg], FHESM1500SCO2 [1520kg]). Split models for refrigerant R744 [CO2] (FHESM600SCO2 [620 kg], FHESM900SCO2 [1040kg], FHESM1500SCO2 [1520kg]). Modèles split pour gaz R744 [CO2] (FHESM600SCO2 [620 kg], FHESM900SCO2 [1040kg], FHESM1500SCO2 [1520kg]).					

Producción en condiciones óptimas: temperatura ambiente 21°C, temperatura agua 15°C.
Production in optimum conditions: room temperature 21°C, water temperature 15°C.
Production dans des conditions optimales: température ambiante 21°C, température de l'eau 15°C.

Almacén fabricante de hielo /
Ice maker storage /
Stockage pour machine à glaçons

Serie / Series / Série **DPE/DI**



DPE240

DI200

DI350

DI550

DPE240

DI200

DI350

DI550

MODELO/MODELE/MODÈLE	DPE240	DI110	DI200	DI350	DI550
Precio Price Prix					
Medidas Measures (mm) Mesures	942 795 1053	560 815 1000	870 790 1000	1250 790 1000	1110 1060 1915
	Medidas sin patas / Measurements without legs / Dimensions sans pieds Patas regulables / Adjustable legs / Pieds réglables [110-160mm]				
Material Material Matériel	Depósito: polietileno / Storage: polyethylene / Stockage: polyéthylène		Depósito / Storage / Stockage: AISI 304		
Almacén Warehouse Stockage (Kg.)	-				
Reserva Reserve Réserve	180	100	200	350	550
Fabricador Manufacturer Machine à glaçons	CM150 / TM160 TM280 / TM510 TM510 SPLIT FHTBM140 / FHTBM250 FHTBM450	TM160 / TM280 TM510 / TM510 SPLIT FHTBM140 FHTBM250 FHTBM450	CM150 / TM160 TM280 / TM510 TM510 SPLIT / ESM250 FHTBM140 / FHTBM250 FHTBM450	CM150 / CM300 / CM300 SPLIT TM280 / TM510 / TM510 SPLIT ESM250 / ESM400 ESM600 FHTBM250 / FHTBM450	TM510 (2) / TM510 (2) SPLIT TM1000 / TM1000 SPLIT ESM400 / ESM600 / ESM900 ESM1500 / ESM1500 SPLIT FHTBM250 / FHTBM450
Opcional Optional Options	-				

Almacén de hielo /
Ice storage /
Stockage pour glaçons

Serie / Series / Série ROLLER BIN
DOBLE ROLLER BIN



MODELO/MODELE/MODÈLE	RBI100	DRBI100	DRBI500	DRBI1200
Precio Price Prix				
Medidas Measures [mm] Mesures	795 1060 1284	1560 1060 1484	1560 1330 1810	1560 1330 2460
Material Material Matériel	Depósito / Storage / Stockage: AISI 304 Contenedor polietileno / Container in polyethylene / Container en polyéthylène			
Almacén Warehouse Stockage [Kg.]	17	50	300	1000
Reserva Reserve Réserve	108	108+108	108+108	108+108
Fabricador Manufacturer Machine à glaçons	FHTM160 FHTM280 FHTM510 / FHTM510 SPLIT FHTBM250 / FHTBM450	FHTM280 / FHTM510 FHESM400 / FHESM600 FHESM400 SPLIT / FHESM600 SPLIT FHTBM140 / FHTBM250 FHTBM450	FHTM510 (2) / FHTM510 SPLIT (2) FHTM1000 / FHTM1000 SPLIT FHESM600 / FHESM600 SPLIT FHESM900 / FHESM900 SPLIT FHESM1500 / FHESM1500 SPLIT FHTBM450	FHTM510 (2) / FHTM510 SPLIT (2) FHTBM450 FHESM600 / FHESM600 SPLIT FHESM900 SPLIT
Opcional Optional Options	-			

Lavavasos y lavaplatos / Glasswasher, dishwasher and hood dishwasher / Lave-vaisselle

A DESTACAR

Estructura interior y exterior en acero inoxidable.

Puerta construida en doble pared.

Guías cesta embutidas, modelos LVP2535, LVP3040 y LVP3250.

Brazos de lavado inferior en acero inoxidable y superior en composite.

Cuba con fondo embutido, dotado con filtro en toda la anchura de la cuba.

Modelo LVP3040 con lavado superior giratorio.

Brazos de aclarado en composite.

Bombas de lavado con sistema DuoFlo excepto en el modelo LV2535, sistema de bomba con una entrada y dos salidas, de esta forma se elimina la pérdida de potencia y el ruido disminuye, mejora el rendimiento y disminuye el consumo de energía, excepto en el modelo LV2535.

Dosificador de abrillantador peristáltico con regulación electrónica al igual que el dosificador detergente [opcional].

Modelos con Bomba desagüe [BD] con descarga parcial, durante el aclarado se introduce agua limpia en la cuba para sustituir la sucia, se realizan aportaciones continuas de agua limpia, cuando termina el ciclo de lavado parte del agua de la cuba ha sido renovada.

Garantizamos un caudal en litros constantes en el aclarado independientemente de la presión del agua de red.

Mesas de entrada y salida, mesa prelavado, etc.

BENEFITS

Interior and exterior structure in stainless steel.

Door made of double wall.

Embossed rack's drives, models LVP2535, LVP3040 y LVP3250.

Lower wash arms in stainless steel and upper composite.

Welded tank, equipped with filter for the entire width of the tank.

Model LVP3040 with rotatory top wash.

Composite rinse arms.

Wash pumps with the DuoFlo system except the model LV2535, pump system with one inlet and two outlets, this eliminates energy loss and noise decreases, improves performance and reduces energy consumption except in the model LV2535.

Dosing of peristaltic rinse aid with electronic regulation as well as dosage detergent [optional].

Models with drain pump [BD] with the partial discharge, during the rinse introduce the clean water in the tank to replace the dirty, continuous contributions of clean water are made, when the washing cycle is finished part of the water of the tank has been renewed.

We guarantee a flow in constant liters in the rinsing regardless of the water pressure of network.

Tables of entrance and exit, prewash table, etc.

À SOULIGNER

Structure intérieure et extérieure en acier inoxydable.

Porte construite en double paroi. Bras de lavage inférieurs en acier inoxydable et composite supérieur.

Modèle LVP3040 avec lavage supérieur.

Bras de rinçage composite.

Nouvelle carte électronique commune pour toute la gamme, avec connexion USB pour sa mise à jour et sa programmation.

Sur l'écran il est possible d'afficher la température de lavage et de rinçage, ainsi que codes d'erreur.

ProSelf programme d'auto-nettoyage à effectuer à la fin de la journée.

Possibilité de régler les feeders de produits à travers la plaque chimique.

Pompes de lavage avec système DuoFlo sauf pour le modèle LV2535, système pompe avec une entrée et deux sorties, ainsi on évite la perte de puissance et le bruit diminue, améliore la performance et diminue la consommation d'énergie, sauf dans le modèle LV2535.

Dosage du liquide de rinçage électroniquement comme le dosage du produit de lavage [option].

Modèles avec pompe de vidange [BD] à décharge partielle, pendant le rinçage de l'eau propre est introduite dans le réservoir pour remplacer l'eau sale, distribution en continu d'eau propre, à la fin du cycle de lavage une partie de l'eau dans le réservoir a été renouvelée.

Nous garantissons un débit en litres constante pendant le rinçage indépendamment de la pression de l'eau du réseau.



Serie / Series / Série **ELECTROMECÁNICA**
ELECTROMECHANICAL
ÉLECTROMÉCANIQUE

+Info: www.infrico.com



LCP4550

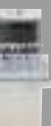

Lavavasos y lavaplatos /
Glasswasher, dishwasher and hood dishwasher /
Lave-vaisselle



LVP3040

LVP3250



Serie / Series / Série **ELECTROMECAÁNICA**
ELECTROMECHANICAL
ÉLECTROMÉCANIQUE

+Info: www.infrico.com



Brazo lavado y aclarado superior modelo LVP3250
Upper washing and rising arm model LVP3250
Bras supérieur de lavage et de rinçage, modèle LVP3250



Bomba de lavado DuFlo
Washing pump DuFlo
Pompe de lavage DuFlo

MODELO/MODELE/MODÈLE	LV2535 LV2535 BD	LVP3040 LVP3040 BD	LVP2845 LVP2845 BD	LVP3250 LVP3250 BD	LCP4550 LCP4550 BD
Precio Price Prix					
Medidas Measures (mm) Mesures	401x490x595	436x535x670	525x555x715	575x605x820	724x818x1529 (2010)
Medidas de cesta Rack measures (mm) Mesures de panier	350x350	400x400	450x450	500x500	500x500
Altura útil de lavado Washing height (mm) Hauteur utile de lavage	250	300	280	325	425/440
Ciclos de lavado estándar Standard washing cycles Durée du cycle	120	120	120	90/150	90/150
Producción horaria Hourly production Production horaire	30	30	30	40/24	40/24
Tensión/Frecuencia Electrical data (V/Hz) Tension électrique	230/50/1N	230/50/1N	230/50/1N	230/50/1N	400/50/3N
Material Material Matériel	AISI 304				
Potencia Máx. funcionam. Max. operating power (W) Puissance maximale	3500			8500	
Pot. resistencia cuba Power tank resist. (W) Puiss. résist. cuvette	600			2100	
Pot. resist. boiler Boiler resist. power (W) Puiss. résist. boiler	2600			3000	8000
Pot. bomba lavado Wash. pump power (W) Puiss. bombe lavé	150	200		470	
Temp. Lavado/Aclar. Wash/rinse temp. (°C) Temp. lavage/rinçage	60°C/80°C				
Capacidad cuba/boiler Tank/boiler capacity (L) Capacité cuvette	7/2,6	9/2,6	14/2,6	20/6	15/6
Consumo agua x cesta Water/rack consumpt. (L) Consomat. eau x panier	1,8			2,2	
Dotación Endowment Dotation	2 Cestos vasos, 1 contenedor cubiertos, 1 insertador platos 2 glass racks, 1 storage cutlery, 1 plate inserter 2 paniers à verre, 1 bac couverts, 1 range assiettes	2 Cestos, 1 contenedor cubiertos, 1 insertador platos 2 Racks, 1 storage cutlery, 1 plats inserter 2 paniers, 1 bac couverts, 1 range assiettes	1 Cesto vasos/1 platos, 1 contenedor cubiertos, 1 insertador platos 1 Glass rack/1 plats, 1 storage cutlery, 1 plats inserter 1 panier à verre/1 assiettes, 1 bac couverts, 1 range assiettes	1 Cesto vasos, 1 cesto platos, 1 contenedor cubiertos 1 Glass rack, 1 rack plats, 1 storage cutlery 1 panier à verre, 1 range assiettes, 1 bac couverts	
Opcional Optional Options	kit dosificador detergente / Detergent dispenser kit / Kit doseur détergent				
	Kit bomba desagüe sin descarga parcial / Drainage pump kit without partial discharge / Kit pompe de vidange sans décharge partielle				
	-	230V/1N/60Hz	-	230V/1N/60Hz	400V/3N/60Hz

Lavavasos y lavaplatos / Glasswasher, dishwasher and hood dishwasher / Lave-vaisselle

A DESTACAR

Estructura interior y exterior en acero inoxidable.

Puerta construida en doble pared.

Guía cesta estampada y embutida, modelos LVP3040E y LVP3250E.

Cuba con fondo embutido, dotado con filtro en toda la anchura de la cuba.

Brazos de lavado inferior en acero inoxidable y superior en composite, excepto en la gama de lavaplatos Cúpula que ambos son en acero inox.

Modelo LVP3040E con lavado superior giratorio.

Brazos de aclarado en composite.

Bombas de lavado con sistema DuoFlo, sistema de bomba con una entrada y dos salidas, de esta forma se elimina la pérdida de potencia y el ruido disminuye, mejora el rendimiento y disminuye el consumo de energía.

Dosificador de abrillantador peristáltico con regulación electrónica al igual que el dosificador detergente [opcional], modelos con código [D] dosificador detergente de serie LCP4560ED y LCP4550EDBDR.

Modelos con Bomba desagüe [BD] con descarga parcial.

Nueva placa de electrónica común para toda la gama, con conexión USB para su actualización y programación.

En el Display posibilidad de visionar temperatura de lavado y aclarado, códigos de errores, así como programas y fases del programa.

Cinco programas de lavado, con posibilidad de modificar tiempos.

Tres programas de tiempos 60, 120 y 150 segundos, lavado continuo y programa de auto limpieza ProSelf a realizar al final de la jornada.

Descarga automática en los modelos con bomba desagüe [BD] con descarga parcial.

Posibilidad de regular a través de la placa los dosificadores de producto químico.

BENEFITS

Embossed rack's drives, models LVP3040E y LVP3250E.

Welded tank, equipped with filter for the entire width of the tank. Interior and exterior structure in stainless steel.

Door made of double wall. Lower wash arms in stainless steel and upper in composite, except in the range of dishwasher Dome that both are in stainless steel.

Model LVP3040E with rotatory top wash.

Composite rinse arms.

Wash pumps with DuoFlo system, pump system with one inlet and two outlets, this eliminates loss of power and noise decreases, improves performance and decreases energy consumption.

Dosing of peristaltic rinse aid with electronic regulation as well as dosage detergent [optional], models with code [D] dosage detergent as standard LCP4560ED and LCP4550EDBDR.

Models with drain pump [BD] with partial discharge.

New common electronics board for the whole range, with USB connection for updating and programming.

In the Display it is possible to view wash and rinse temperature, error codes as well as programs and program phases.

Five washing programs, with the possibility of changing times.

Three 60, 120 and 150 second time programs, continuous washing and ProSelf self cleaning program to be performed at the end of the day and automatic discharge in the models with partial discharge drain [BD].

Possibility of regulating through the plate the chemical dosificadores.

À SOULIGNER

Structure intérieure et extérieure en acier inoxydable.

Porte construite en double paroi.

Bras de lavage inférieurs en acier inoxydable et composite supérieur.

Modèle LVP3040 avec lavage supérieur.

Bras de rinçage composite.

Nouvelle carte électronique commune pour toute la gamme, avec connexion USB pour sa mise à jour et sa programmation.

Sur l'écran il est possible d'afficher la température de lavage et de rinçage, ainsi que les codes d'erreur.

ProSelf programme d'auto-nettoyage à effectuer à la fin de la journée.

Possibilité de réguler les doses de produit chimique.

Sur l'écran il est possible d'afficher la température de lavage et de rinçage, ainsi que codes d'erreur.

ProSelf programme d'auto-nettoyage à effectuer à la fin de la journée.

Possibilité de régler les feeders de produits à travers le contrôle électronique.

Pompes de lavage avec système DuoFlo sauf pour le modèle LV2535, système pompe avec une entrée et deux sorties, ainsi on évite la perte de puissance et le bruit diminue, améliore la performance et diminue la consommation d'énergie, sauf dans le modèle LV2535.

Dosage du liquide de rinçage électroniquement comme le dosage du produit de lavage [option].

Modèles avec pompe de vidange [BD] à décharge partielle, pendant le rinçage de l'eau propre est introduite dans le réservoir pour remplacer l'eau sale, distribution en continu d'eau propre, à la fin du cycle de lavage une partie de l'eau dans le réservoir a été renouvelée.

Nous garantissons un débit en litres constant pendant le rinçage indépendamment de la pression de l'eau du réseau.



Serie / Series / Série **ELECTRÓNICA**
ELECTRONIC
ÉLECTRONIQUE

+Info: www.infrico.com

LCP4550E

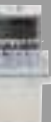

Lavavasos y lavaplatos / Glasswasher, dishwasher and hood dishwasher / Lave-vaisselle



Modelo LCP4550EDBDRC con Recuperador de Calor RC

Aspira el vapor que se forma después del aclarado y lo condensa, el calor recuperado aumenta en 25°C la temperatura del agua que entra. Se obtiene un importante ahorro de energía gracias a la reducción en casi un 40%, de la variación térmica que el boiler debe proporcionar al agua del aclarado. Se produce al final el ciclo y elimina la descarga de vapor al abrir la capota.

Model LCP4550EDBDRC with RC Heat Recovery

Aspirates the vapor that forms after the rinsing and condenses it, the recovered heat increases in 25°C the incoming water temperature. Significant energy savings are achieved thanks to a 40% reduction in the thermal variation that the boiler must provide to rinse water. It produces the cycle at the end and eliminates the discharge of steam when opening the canopy.

Modèle LCP4550EDBDRC avec Récupération de chaleur RC

Aspire la vapeur qui se forme suite au rinçage et la condense, la chaleur récupérée augmente de 25°C la température de l'eau entrante. On obtient une importante économie d'énergie grâce à la réduction (presque de 40%) de la variation thermique que le boiler doit proportionner à l'eau de rinçage.



LVP3250E



Serie / Series / Série **ELECTRÓNICA** **ELECTRONIC** **ÉLECTRONIQUE**

+Info: www.infrico.com

Capacidad bandejas
600x400 o GN 1/1
Capacity trays
600x400 or GN 1/1
Capacité plateaux
600x400 ou GN 1/1



Cuba embutida LCP 4550E
Stamped pan LCP 4550E
Cuve emboutie LCP 4550E



Cuba LCP 4560E
Pan LCP4560E
Cuve LCP 4560E

Nomenclatura / Nomenclature / Nomenclature:

E: Gama electrónica / Electronic range / Gamme électronique





D: Dosificador detergente de serie / Detergent dosing standard / Doseur détergent de série

BD: Bomba desagüe parcial de serie / Partial discharge pump standard / Pompe à vidange partielle de série

RC: Recuperador de calor / Heat recovery system / Récupération de chaleur







MODELO/MODELE/MODÈLE	LVP3040E LVP3040EDBD	LVP3250E LVP3250EDBD	LCP4550E LCP4550EDBD	LCP4560E LCP4560EDBD	LCP4550EDBDRC
Precio Price Prix					
Medidas Measures (mm) Mesures	436x535x670	575x605x820	724x818x1529 [2010]	788x835x1565 [2080]	724x818x2229
Medidas de cesta Rack measures (mm) Mesures de panier	400x400	500x500	500x500	600x500	500x500
Altura útil de lavado Washing height (mm) Hauteur utile de lavage	300	325	425 / 440	440	425 / 440
Ciclos de lavado estándar Standard washing cycles Durée du cycle	60/120/150 Autolimpieza/Self-cleaning/ Autonettoyant	60/120/150 Continuo/Autolimpieza / Continuous/Self-cleaning / Continu/Autonettoyant			
Producción horaria Hourly production Production horaire	40/30/24				
Tensión/Frecuencia Electrical data (V/Hz) Tension électrique	230/50/1N		400/50/3N		
Material Material Matériel	AISI 304				
Potencia Máx. funcionam. Max. operating power (W) Puissance maximale	3500		8700	9500	8700
Pot. resistencia cuba Power tank resist. (W) Puiss. résist. cuvette	600	2100	2500	2500	2500
Pot. resist. boiler Boiler resist. power (W) Puiss. résist. boiler	2600	3000	8000		
Pot. bomba lavado Whash. pump power (W) Puiss. bombe lavé	200	470	650	1500	650
Temp. Lavado/Aclar. Wash/rinse temp. (°C) Temp. lavage/rinçage	60°C/80°C				
Capacidad cuba/boiler Tank/boiler capacity (L) Capacité cuvette	9/2,6	20/6		30/6	20/12
Consumo agua x cesta Water/rack consumpt. (L) Consomat. eau x panier	1,8	2,2		2,6	2,2
Dotación Endowment Dotation	1 Cesto vasos/1 platos, 1 conten cubiertos, 1 insertador platos 1 Glass rack/1 plats, 1 storage cutlery, 1 plats inserter 1 panier à verre/1 assiettes, 1 bac couverts, 1 range assiettes		1 Cesto vasos, 1 cesto platos, 1 contenedor cubiertos 1 Glass rack, 1 rack plats, 1 storage cutlery 1 panier à verre, 1 range assiettes, 1 bac couverts		
Opcional Optional Options	kit dosificador detergente / Detergent dispenser kit / Kit doseur détergent				
	Kit bomba desagüe sin descarga parcial / Drainage pump kit without partial discharge / Kit pompe de vidange sans décharge partielle				

Accesorios lavaplatos cúpula / Dishwasher accessories / Accessoires lave-vaisselles

Descripción Description Description	Medidas (mm) Measures (mm) Mesures (mm)	Imagen Image Image	Código Code Code	Precio Price Prix
Mesa entrada/ salida con entrepaño 700mm Entry/ out table 700 mm Table entrée/sortie 700 mm	700x575x850		MCP80202	
Mesa con peto derecha 700mm Table right backsplash 700 mm Table avec dosseret à droite 700 mm	700x715x850		MCP80200	
Mesa con peto derecha 1200mm Table right backsplash 1200 mm Table avec dosseret à droite 1200 mm	1200x715x850		MCP80204	
Mesa con peto izquierda 700mm Table left backsplash 700 mm Table avec dosseret à gauche 700 mm	700x715x850		MCP80201	
Mesa con peto izquierda 1200mm Table left backsplash 1200 mm Table avec dosseret à gauche 1200 mm	1200x715x850		MCP80203	
Mesa con fregadero izquierda 700mm. Cuba 50x40cm Table sink left 70 mm Sink 50x40 cm Table avec évier à gauche 700 mmCuve 50x40 cm	700x715x850		MCP80205L700	
Mesa con fregadero derecha 700mm. Cuba 50x40cm Table sink right 700 mm Sink 50x40 cm Table avec évier à droite 700 mmCuve 50x40 cm	700x715x850		MCP80206L700	

Accesorios lavaplatos cúpula / Dishwasher accessories / Accessoires lave-vaisselles

+Info: www.infrico.com

Descripción Description Description	Medidas (mm) Measures (mm) Mesures (mm)	Imagen Image Image	Código Code Code	Precio Price Prix
Mesa con fregadero izquierda 1200mm. Cuba 50x40cm Table sink left 1200 mm Table avec évier à gauche 1200 mm. Cuve 50x40 cm	1200x715x850		MCP80205	
Mesa con fregadero derecha 1200mm. Cuba 50x40cm Table sink right 1200 mm Table avec évier à droite 1200 mm. Cuve 50x40 cm	1200x715x850		MCP80206	
Mesa prelavado con fregadero y orificio izquierdo de desbrasado 1200mm. Cuba 50x40cm Prewash table sink left 1200 mm Table pré lavage avec évier et orifice à gauche 1200 mm. Cuve 50x40 cm	1200x715x850		MCP80207	
Mesa prelavado con fregadero y orificio derecho de desbrasado 1200mm. Cuba 50x40cm Prewash table sink right 1200 mm Table pré lavage avec évier et orifice à droite 1200 mm. Cuve 50x40 cm	1200x715x850		MCP80208	
Anillo de goma para desbrasado Rubber ring Joint en caoutchouc	-		199064	
Grifo ducha prelavado Prewash faucet shower Robinet pré lavage	-		799003	
Cubo residuos en inox con ruedas Waste bin inox with casters Poubelle en inox sur roulettes	-		704002	



Lavautensilios y lavaperolas / Dishwasher / Lave-ustensiles

A DESTACAR

Se trata de la solución ideal para obradores de panadería, pastelería y heladería.

Estructura en doble pared en acero Inox, este diseño nos permite reducir la dispersión térmica y acústica. Obtenemos valores de dispersión térmica de más de un -60%.

Brazos de lavado y aclarado en paralelo superior e inferior en composite, excepto en los modelos LP8570 y LP85132 que son en acero inoxidable, garantizan resultados óptimos de lavado.

Nueva placa electrónica común para todos los modelos.

Display con pantalla LCD a color, permite visionar temperatura de lavado, aclarado, códigos de errores, programas y fases del programa.

Nueve programas de lavado, cinco básicos de duración en segundos 120, 240, 360, 720, autolimpieza **ProSelf** y cuatro adicionales.

Puerto USB de conexión para actualizar el software y programación.

Diseño de la cuba con cantos redondeados y ausencia de tapón rebosadero, todos los modelos equipan bomba de desagüe, con renovación parcial del agua de lavado.

Filtro de cuba en acero inoxidable. Bombas de lavado con sistema **DuoFlo**, sistema de bomba de lavado con una entrada y dos salidas, se elimina pérdida de potencia y se consigue una disminución del ruido, mejorando el rendimiento y reduciendo el consumo a la vez que se garantiza un mejor y mayor reparto del caudal del agua de lavado.

Sistema de aclarado **UltraRinse** (presión de aclarado constante), nos permite mantener temperatura del agua constante durante la fase de aclarado, así como una presión y caudal del agua del aclarado constante independientemente de las condiciones de la red hidráulica.

Dosificador de abrillantador y detergente peristálticos, con posibilidad de regularlos en el panel de mandos.

Todos los modelos equipan de serie **bomba de desagüe** con descarga parcial, lo que significa que durante el lavado se introduce agua limpia en la cuba para sustituir la sucia, se realizan aportaciones continuas de agua limpia, cuando termina el ciclo parte del agua de la cuba ha sido renovada.

Opcional:

Soportes bandejas, contenedor cubiertos inox, insertador en forma de embudo para confitería, etc.

Brazos de lavado acero inoxidable
Stainless steel washing arm
Bras de lavage en acier inoxydable



Auto limpieza de la cuba
Self-cleaning drum
Auto-nettoyage de la cuve



Cuba estampada
Printed drum
Cuve emboutie



Á SOULIGNER

C'est la solution idéale pour les boulangeries, pâtisseries et magasins de crème glacée.

Structure à double paroi en acier inoxydable, cette conception nous permet de réduire la dispersion thermique et acoustique. Nous obtenons des valeurs de dispersion thermique supérieures à -60%.

Les bras de lavage et de rinçage parallèles supérieurs et inférieurs en composite, à l'exception des modèles LP8570 et LP85132, qui sont en acier inoxydable, garantissent des résultats de lavage optimaux.

Nouvelle carte électronique commune à tous les modèles.

L'affichage avec écran LCD couleur permet de visualiser la température de lavage, le rinçage, les codes d'erreur, les programmes et les phases du programme.

Neuf programmes de lavage, cinq basiques d'une durée de 120, 240, 360, 720, auto-nettoyage **ProSelf** et quatre autres.

Port de connexion USB pour mettre à jour le logiciel et la programmation.

Conception du réservoir avec bords arrondis et absence de bouchon de trop-plein, tous les modèles équipés d'une **pompe de vidange**, avec renouvellement partiel de l'eau de lavage.

Filtre de réservoir en acier inoxydable.

Gran capacidad de trabajo
High working capacity
Grande capacité de travail



Opcional Optional Options	SopORTE 8 bandejas prof. máx. 4cm para LP (50x50cm) Support 8 trays max. depth 4cm for LP (50x50cm) Support 8 plateaux profond. maxi 4cm pour LP (50x50cm)	SopORTE Inox 5 bandejas para LP prof. máx. 6,5cm (50x50cm) Support stainless steel 5 trays for LP max. depth 6,5cm (50x50cm) Support inox 5 plateaux profond. maxi 6,5 cm pour LP (50x50cm)
	Contenedor cubiertos inox LP Cutlery storage stain. steel LP Récipient couverts inox LP	Insertador embudo para confitería LP Funnel inserter for pastry LP Inserteur entonnoir à boulangerie LP

Serie / Series / Série **LP**

+Info: www.infrico.com



LP4060



LP6561



LP8561



LP8570



LP85132

MODELO/MODELE/MODÈLE	LP4060	LP6561	LP8561	LP8570	LP85132
Precio Price Prix					
Medidas Measures (mm) Mesures	600x700 [1135] x1228	719x782 [1180] x1727 [1997]	719x782 [1330] x1927 [2243]	853x857 [1400] x1959 [2274]	1465x857 [1400] x1959 [2274]
Medidas de cesta Rack measures (mm) Mesures de panier	500x600	550x610		700x700	1320x700
Altura útil de lavado Washing height (mm) Hauteur utile de lavage	405 / 380	650 / 600		850 / 800	
Ciclos de lavado estándar Standard washing cycles Durée du cycle	9 Ciclos, 5 básicos 120, 240, 360, autolimpieza y 720 9 Cycles, 5 basic cycles 120, 240, 360, self-cleaning and 720 9 Cycles, 5 basiques 120, 240, 360, autonettoyage et 720				
Producción horaria Hourly production Production horaire	30				
Tensión/Frecuencia Electrical data (V/Hz) Tension électrique	400/50/3N				
Material Material Matériel	AISI 304				
Potencia Máx. funcionam. Max. operating power (W) Puissance maximale	9800	7500		10700	15900
Pot. resistencia cuba Power tank resist. (W) Puiss. résist. cuvette	2100	3000		8000	10500
Pot. resist. boiler Boiler resist. power (W) Puiss. résist. boiler	7000	6000		8000	10500
Pot. bomba lavado Whash. pump power (W) Puiss. bombe lavé	700	1500		3000	2 x 2700
Temp. Lavado/Aclar. Wash/rinse temp. (°C) Temp. lavage/rinçage	55°C a 65°C/80°C a 85°C				
Capacidad cuba/boiler Tank/boiler capacity (L) Capacité cuvette	23/7	37/12		68/12	131/17
Consumo agua x cesta Water/rack consumpt. (L) Consomat. eau x panier	2,4	3		4	6
Dotación Endowment Dotation	1 Cesto universal inoxidable 1 Universal stainless steel rack 1 Panier universel inoxydable	1 Cesto universal inoxidable 1 Universal stainless steel rack 1 Panier universel inoxydable		1 Cesto universal inoxidable 1 Universal stainless steel rack 1 Panier universel inoxydable	1 Cesto universal inoxidable 1 Universal stainless steel rack 1 Panier universel inoxydable

Túneles de lavado y arrastre / Rack conveyor dishwasher / Tunnels de lavage

A DESTACAR

Estructura fabricada en doble pared en acero inox, este diseño nos permite reducir el ruido y la pérdida de calor. Puertas en doble pared con aislamiento.

Altura útil de carga 450mm, nos permite lavar objetos de mayor tamaño.

Diseño realizado para facilitar su limpieza, cuba de lavado embutida sin tubos interiores con sistema de doble y triple filtro de suciedad del agua, con recogida de residuos.

Filtrado secuencial exclusivo en los modelos TA31111 y TA31112, se trata de la combinación de filtros y de otros filtros de cajón, ambos en la cuba, estos sistemas nos permiten realizar un filtrado progresivo del agua del lavado quedando depositadas todas las partículas de diámetro superior a 1mm. Estos filtros de cajón son extraíbles.

En la aspiración de cada bomba hay otro filtro de seguridad para el agua.

Modelos TA31102 y TA31112 con módulo de prelavado de 820mm de longitud y cuba de 70L, sistema de lavado compuesto por 3 brazos y una bomba de lavado de doble flujo de 1500W.

Módulo de lavado de longitud 1150mm con una cuba de 70 l y sistema de lavado de 5 brazos con bomba de lavado de doble flujo.

Bomba de lavado con sistema DuoFlow, se elimina la división del flujo obteniendo menores pérdidas de carga y menor ruido.

Modelo TA31101 y TA31102 con dos programas de lavado, TA31111 y TA31112 con cuatro programas de lavado.

Sistema de aclarado con presión de red de agua entre 2 y 4.

Brazos de aclarado fabricados en composite, disponen en su interior unas canalizaciones que aseguran el flujo de agua con la menor carga posible. Boquillas fabricadas en acero.

Modelos TA31111 y TA31112 con sistema de aclarado ProRinse, que utiliza una bomba de aclarado de 200W que garantiza una presión y caudal constante del agua del aclarado sean cuales sean las condiciones de suministro de la red. Estos modelos concretos disponen del aclarado proporcional que permite variar la cantidad del agua del aclarado en función del programa de lavado permitiendo hasta un ahorro del consumo del agua del 25%.

Modelo TA31111
Lavado y aclarado con accesorios opcionales

Model TA31111
Washing and rinsing with optional accessories

Modèle TA31111
lavage et rinçage avec accessoires en options

BENEFITS

Structure made in double wall in stainless steel, this design allows us to reduce noise and loss of heat. Double wall doors with insulation. Useful loading height 450mm, allows us to wash larger objects.

Designed to facilitate cleaning, built-in wash tub without internal tubes with double and triple filter system of dirt from the water, with waste collection.

Exclusive sequential filtering on the TA31111 and TA31112 models, this is the combination of filters and other drawer filters, both in the tank, these systems allow us to perform a progressive filtering of the washing water, leaving all particles with a diameter greater than 1mm. These drawer filters are removable.

In the suction of each pump there is another filter of safety for the water.

Models TA31102 and TA31112 with prewash module of 820mm length and 70L tub, washing system composed of 3 arms and a dual flow washing pump of 1500W.

Wash module of length 1150mm with a tank of 70 l and system of washing of 5 arms with pump of washing of double flow.

Wash pump with DuoFlow system, eliminates the division of the flow obtaining smaller losses of load and less noise.

Model TA31101 and TA31102 with two washing programs, TA31111 and TA31112 with four washing programs.

Rinse system with water supply pressure between 2 and 4 bar.

Rinse arms made of composite, have pipes inside that ensure the flow of water with the lowest possible load. Nozzles made of steel.

Models TA31111 and TA31112 with ProRinse rinse system, which uses a 200W rinse pump to ensure a constant pressure and flow rate of the rinse water regardless of the supply conditions of the network. These specific models have a proportional rinse that allows the amount of rinse water to be varied depending on the washing program, allowing up to 25% water consumption savings.

À SOULIGNER

Structure à double paroi en acier inoxydable, cette conception nous permet de réduire les pertes de bruit et de chaleur. Portes à double paroi avec isolation.

Hauteur utile 450 mm, nous permet de laver des objets plus gros.

Conçu pour faciliter le nettoyage, bac de lavage embouti sans tubes intérieurs avec système double et triple filtre de la saleté de l'eau, avec la collecte des déchets.

Filtrage séquentiel exclusif sur les modèles TA31111 et TA31112, il s'agit de la combinaison de filtres et d'autres filtres à tiroir, tous deux installés dans le réservoir. Ces systèmes nous permettent d'effectuer un filtrage progressif de l'eau de lavage en laissant toutes les particules présentes dans le réservoir (diamètre supérieur à 1mm). Ces filtres à tiroir sont amovibles.

Dans l'aspiration de chaque pompe, il y a un autre filtre de sécurité de l'eau.

Modèles TA31102 et TA31112 avec module de prélavage de 820mm de long et réservoir de 70L, système de lavage composé de 3 bras et d'une pompe de rinçage à double flux de 1500W.

Module de lavage de 1150 mm de long avec cuvette de 70 l et système de lavage à 5 bras avec pompe de lavage à double flux.

Pompe de lavage avec système DuoFlow, la division du flux est éliminée, ce qui permet d'atténuer les pertes de charge et le bruit.

Modèles TA31101 et TA31102 avec deux programmes de lavage, TA31111 et TA31112 avec quatre programmes de lavage.

Système d'allègement avec une pression du réseau d'eau comprise entre 2 et 4 bras d'allègement en composite, ils comportent des canaux intérieurs qui assurent le débit d'eau avec la charge la plus faible possible.

Buses en acier.

Les modèles TA31111 et TA31112 avec le système de rinçage ProRinse, qui utilise une pompe de rinçage 200 W, garantissent une pression et un débit constants de l'eau de rinçage quelles que soient les conditions d'alimentation du réseau. Ces modèles disposant d'un rinçage proportionnel qui permet de faire varier la quantité d'eau de rinçage en fonction du programme de lavage, permettant ainsi d'économiser jusqu'à 25% de la consommation d'eau.



Serie / Series / Série TA

+Info: www.infrico.com

Modelo TA31102/31112
Prelavado, lavado y aclarado
con accesorios opcionales.

Model TA31102/31112
 Pre-washing, washing and rinsing with
 optional accessories.

Modèle TA31102/31112 Prélavage,
 lavage et rinçage avec accessoires
 en options.



MODELO/MODELE/MODÈLE	TA31101 Lavado y Aclarado Wash, Rinse Lavage, Rinçage	TA31102 Prelavado, Lavado, Aclarado Pre-wash, Wash, Rinse Prélavage, Lavage, Rinçage	TA31111 Lavado y Aclarado Wash, Rinse Lavage, Rinçage	TA31112 Prelavado, Lavado, Aclarado Pre-wash, Wash, Rinse Prélavage, Lavage, Rinçage	
Precio Price Prix					
Medidas Measures (mm) Mesures	1150x770x1615(2088)	1968x770x1615 (2088)	1150x770x1615 (2088)	1968x770x1615 (2088)	
Medidas de cesta Rack measures (mm) Mesures de panier	500x500				
Altura útil de lavado Washing height (mm) Hauteur utile de lavage	450				
Productividad máxima Max. productivity Productivité max. (cestas/h. racks/h. paniers/h)	Máx. capacidad / Max. capacity / Max. capacité	120	200	160	270
	Baja velocidad / Low speed / Faible vitesse	60	110	60	110
	Tercera velocidad / 3rd speed / 3eme vitesse	-	-	120	200
	Vasos / glasses / verres	-	-	80	135
Tensión/Frecuencia Electrical data (V/Hz) Tension électrique	400/50/3N				
Potencia Total Max. power (W) Puissance maximale	Agua caliente / Hot water / Eau chaude 50°	22000	29500	22000	29700
	Agua fría / Cold water / Eau froide 10°	28500	41000	31700	41200
	Agua fría con recuperador de calor / Cold water with heat recovery / Eau glacée avec récupération de chaleur	24700	34200	24900	34400
Pot. resistencia cuba Power tank resist. (W) Puiss. résist. cuvette	10500				
Pot. resist. boiler Boiler resist. power (W) Puiss. résist. boiler	9500/1600/12000	15500/27000/20000	9500/19000/12000	15500/27000/20000	
Pot. bomba lavado / Washing / Pre-washing pump power / (W) Puissance bombe lavage / pré-lavage	1500 / -	1500 / 1500	1500 / -	1500 / 1500	
Temp. Lavado/Aclar. Wash/rinse temp. (°C) Temp. lavage/rinçage	Máx. capacidad / Max. capacity / Max. capacité	60°C/82°C		63°C/82°C	
	Baja velocidad / Low speed / Faible vitesse	60°C/82°C		63°C/82°C	
	Tercera velocidad / 3rd speed / 3eme vitesse	-		60°C/82°C	
	Vasos / glasses / verres	-		60°C/65°C	
Consumo agua x cesta Water/rack consumpt. (L) Consomat. eau x panier	160	270	140-200	240-320	
Capacidad cuba/boiler Tank/boiler capacity (L) Capacité cuvette	70/17				
Dotación Endowment Dotation	1 Cesto platos, 1 cesto plano, 1 contenedor cubiertos / 1 Plats rack, 1 flat rack, 1 storage cutlery / 1 panier assiettes, 1 range plat, 1 bac couverts				

Accesorios lavavajillas de arrastre / Tunnels of wash accesories / Accessoires tunnels de lavage

Descripción Description Description	Medidas (mm) Measures (mm) Mesures (mm)	Imagen Image Image	Código Code Code	Precio Price Prix
Prelavado en ángulo Angle pre-wash Prélavage en angle TA31102, TA31112 [P]	990x820x1565		P	
Modulo secado Túnel Arrastre Drying module Tunnel conveyor Module séchage tunnel TA [A]	600x770x177,5		A	
Modulo secado Túnel Arrastre Drying module Tunnel conveyor Module séchage tunnel TA [L]	600x770x1775		L	
Modulo secado en ángulo Angle drying module Module séchage en angle TA [B]	820x879x1775		B	
Modulo secado en ángulo Angle drying module Module séchage en angle TA [I]	820x879x1775		I	
Extractor vapor Steam extractor Extracteur de vapeur [E]	Diámetro 25- h 21 Diameter 25- h 21 Diamètre 25- h 21		E	
Recuperador de calor condensador de vahos Vapour condenser heat recovery unit Récupérateur de chaleur ou condensateur de buées TA [R]	Diámetro 25- h 21 Diameter 25- h 21 Diamètre 25- h 21		R	
Kit aumento resistencia calderín 9,5Kw [W] Kit to increase boiler resistance 9,5Kw [W] Kit supplément résistance 9,5Kw [Réf. W]	-		W	
Dosificador de detergente y abrillantador TA [Y] Detergent and rinse aid dosing unit TA [Y] Doseur de détergent et brillant TA [Réf. Y]	-		Y	
Interruptor Bloqueo emergencia [X] Emergency lock switch [X] Interrupteur blocage urgence [Réf. X]	-		X	
Reducción de presión con manómetro Pressure reduction with gauge Réduction de pression avec manomètre TA 31101, Ta31102 [N]	-		N	
Sonda nivel producto químico Chemical level sensor Sonde niveau produit chimique	-		999257	
Kit micro interruptor final de carrera Limit switch micro kit Kit micro interrupteur fin de course	-		75861	

Cuba embutida
Stamped pan
Cuve emboutie



Filtro
Filter
Filtre



Bomba lavado Duoflow
Washing pump Duoflow
Pompe lavage Duoflow

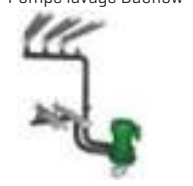

**Otras medidas o modelos consultar
disponibilidad y precio.**

For any other measurement or models,
consult availability and price.

Autres dimensions et modèles,
nous consulter.

Accesorios lavavajillas de arrastre / Tunnels of wash accesories / Accessoires tunnels de lavage

+Info: www.infrico.com

Descripción Description Description	Medidas (mm) Measures (mm) Mesures (mm)	Imagen Image Image	Código Code Code	Precio Price Prix
Mesa entrada/salida con entrepaño 700-1100mm Entry/ out table 700-1100 mm Table entrée/sortie 700-1100 mm	700x700x850		75482	
	1100x700x850		75483	
Mesa entrada/salida para secado 700-1100mm Entry/out table for drying 700-1100mm Table entrée/sortie pour séchage 700-1100mm	700x700x850		75484	
	1100x700x850		75485	
Mesa esquina para máquina con salida izquierda Corner table for machine with left exit Table angle avec sortie à gauche	600x650x850		75480	
Mesa esquina para máquina con salida derecha Corner table for machine with right exit Table angle avec sortie à droite	600x650x850		75481	
Mesa con fregadero (50x40cm) Máquina salida derecha 1200-1500-1800mm Sink table (50x40cm) Machine right exit 1200-1500-1800mm Table avec évier (50x40cm) sortie à droite 1200-1500-1800mm	1200x700x850		75451	
	1500x700x850		75452	
	1800x700x850		75453	
Mesa con fregadero (50x40cm) máquina salida izquierda 1200-1500-1800mm Sink table (50x40cm) Machine left exit 1200-1500-1800mm Table avec évier (50x40cm) sortie à gauche 1200-1500-1800mm	1200x700x850		75456	
	1500x700x850		75457	
	1800x700x850		75458	
Mesa prelavado con fregadero (50x40cm) y desbrasado para máquina salida derecha 1200-1500-1800mm Sink prewash table (50x40cm) Machine right exit 1200-1500-1800mm Table pré lavage avec évier (50x40cm) sortie à droite 1200-1500-1800mm	1200x700x850		75446	
	1500x700x850		75447	
	1800x700x850		75448	
Mesa prelavado con fregadero (50x40cm) y desbrasado para máquina salida izquierda 1200-1500-1800mm Sink prewash table (50x40cm) Machine left exit 1200-1500-1800mm Table pré lavage avec évier (50x40cm) sortie à gauche 1200-1500-1800mm	1200x700x850		75441	
	1500x700x850		75442	
	1800x700x850		75443	
Mesa rodillos con cuba y patas 1100-1600-2100-2600mm (Elemento de cierre +45mm) Roller table with tank and legs 1100-1600-2100-2600mm (closing element +45mm) Table à rouleaux avec cuve et pieds 1100-1600-2100-2600mm (élément fermeture +45mm)	1145x630x875		717066	
	1645x630x875		717067	
	2145x630x875		717086	
	2645x630x875		717087	
Mesa rodillos con cuba y patas sobre ruedas 1100-1600-2100mm (Elemento de cierre +45mm) Roller table with bowl and legs on casters 1100-1600-2100mm (closing element +45mm) Table à rouleaux avec cuve et pieds sur roulettes 1100-1600-2100mm (élément fermeture +45mm)	1145x630x875		717069	
	1645x630x875		717070	
	2145x630x875		717088	
Curva con rodillos 90° Roller curve 90° Table courbe à rouleaux 90°	1100x1100x875		717068	



Congelador tapa abatible / Lid chest freezer / Congélateur avec couvercle battant

Serie / Series / Série **HF**

HF 500 AL HC

Controlador digital
Adjustable thermostat
Thermostat réglable



MODELO/MODELE/MODELE	HF 240 AL HC	HF 320 AL HC	HF 400 AL HC	HF 500 AL HC	HF 550 AL HC	HF 700 AL HC
Precio Price Prix						
Medidas ↔ Measures [mm] ↗ Mesures ↓	830 660 860	990 660 860	1170 660 860	1400 660 860	1600 660 860	1570 751 1027
Tensión/Frecuencia Electrical data [V/Hz] Tension électrique	220V-240V/50Hz					
Material Material Matériel	Ext: Chapa galvanizada plastificada blanco / Galvanised steel white plastic coated / Tôle galvanisée plastifiée blanc. Int: Cuba interior en aluminio / Aluminium inner tank / Cuve intérieure en aluminium					
Capacidad Capacity [L] Capacité	176	220	285	344	439	664
Nº Cesta [serie/opción] Nº baskets [standard/optional] Nº Paniers [série/option]	2/0	2/1	2/2	2/3	2/4	2/4
Compresor Compressor Compresseur	1/9	1/9	1/7	1/6	1/3	1/3
Temperatura Temperature [32°C] Température	-17°C / -25°C					
Condensación Condensation Condenseur	Estática / Static / Statique					Ventilada / Ventilated / Ventilée
Evaporación Evaporation Evaporateur	Estática / Static / Statique					
Desescarche Defrost [Kg.] Dégivrage	Manual / Manual / Manuel					
Capac. Congelación Freezing capacity Puissance congélation	12	16	18	20	24	42
Potencia Power [W] Puissance	133	130	161	180	195	220
Refrigerante Refrigerant Gaz	HC R600a					R290
Clase energética Energy class Classe énergétique	F				-	
Opcional Optional Options	Cesta / Basket / Panier Cesta / Basket / Panier HF 700					

Conservadora puerta corredera / Sliding doors conservator / Congélateur avec couvercle coulissant

Serie / Series / Série **HF**

HF 400 TCG

Controlador digital
Adjustable thermostat
Thermostat réglable



Mod. TCC
Tapa ciega
Solid lid
Couvercle plein



Mod. TCG
Tapa cristal con llave
Glass lid with key
Couvercle en verre avec clé

MODELO/MODELE/MODÈLE	HF 300 TCG HF 300 TCC HC	HF 400 TCG HF 400 TCC HC	HF 500 TCG HF 500 TCC HC
Precio Price Prix			
Medidas  Measures (mm) Mesures	1063 670 900	1283 670 900	1503 670 900
Tensión/Frecuencia Electrical data [V/Hz] Tension électrique	220V-240V/50Hz		
Material Material Matériel	Ext: Chapa galvanizada plastificada blanco / Galvanised steel white plastic coated / Tôle galvanisée plastifiée blanc. Int: Cuba interior en aluminio / Aluminium inner tank / Cuve intérieure en aluminium		
Capacidad Capacity [L] Capacité	256	327	398
Nº Cesta [serie/opción] Nº baskets [standard/optional] Nº Paniers [série/option]	Mod. TCG 2/2 Mod. TCC -	Mod. TCG 2/3 Mod. TCC -	Mod. TCG 2/4 Mod. TCC -
Compresor Compressor Compresseur	1/6	1/3	1/3
Temperatura Temperature [32°C] Température	-18°C / -24°C		
Condensación Condensation Condenseur	Ventilada / Ventilated / Ventilée		
Evaporación Evaporation Évaporateur	Estática / Static / Statique		
Desescarche Defrost [Kg.] Dégivrage	Manual/ Manual / Manuel		
Capac. Congelación Freezing capacity Puissance congélation	23	25	27
Potencia Power [W] Puissance	135	190	190
Refrigerante Refrigerant Gaz	HC R600a		
Clase energética Energy class Classe énergétique	F		
Opcional Optional Options	Cesta / Basket / Panier TCG		



Congeladores tapa abatible (-60°C) / Lid Chest freezers (-60°C) / Congélateurs avec couvercle battant (-60°C)

**IDEAL PARA ALMACENAR
ATÚN PARA SUSHI**

**IDEAL FOR STORING
TUNA FISH FOR SUSHI**

**IDÉAL POUR CONSERVER
LE THON POUR LE SUSHI**



Controlador digital
Adjustable thermostat
Thermostat réglable

MODELO
MODELE
MODÈLE

PRO 11

PRO 21

PRO 31

PRO 41

PRO 60

MODELO MODELE MODÈLE	PRO 11	PRO 21	PRO 31	PRO 41	PRO 60
Precio Price Prix					
Temperatura Temperature (°C) Température	-30°C/-60°C				
Medidas Measures (EXT) Mesures	725 x 655 x 865 mm.	1055 x 655 x 865 mm.	1305 x 655 x 865 mm.	1505 x 655 x 865 mm.	1705 x 655 x 865 mm.
Medidas Measures (INT) Mesures	520 x 450 x 650 mm.	850 x 450 x 650 mm.	1100 x 450 x 650 mm.	1300 x 450 x 650 mm.	1540 x 450 x 650 mm.
Tensión/Frecuencia Electrical data Tension électrique	220V/50Hz				
Controlador Controller Régulateur	Dixell Digital con alarma acustica / Contacto libre para conectar a alarma externa / Dixell Digital with acoustic alarm / Free contact for connection to external alarm / Dixell Digital avec alarme sonore / Contact libre pour connexion à une alarme externe				
Aislamiento Isolation (mm) Isolation	102,5mm				
Capacidad Capacity (L NETOS) Capacité	130	226	300	360	481
Nº Cesta [serie/opción] Nº baskets (standard/optional) Nº Paniers [série/option]	0/2	0/3	0/4	0/5	-
Condensación Condensing Condensation	Condensador interior en parte trasera, condensador estatico en la trasera y ventilador de apoyo al compresor / Inner rear condenser, rear static condenser and compressor support fan / Condenseur intérieure à l'arrière, condenseur statique à l'arrière et ventilateur de support du compresseur.				
Evaporador Cooler Évaporateur	Estático (tubo de aluminio) / Static (aluminium tube) / Statique (tube d'aluminium)				
Desescarche Defrost Dégivrage	Manual / Manual / Manuel				
Potencia Power (W) Puissance	375	455	544	587	612
Consumo Consumption (kWh/24h) Consommation	4,3	5	5,2	6,1	9,2
Refrigerante Refrigerant Gaz	R600a + R1150				
Opcional Optional Options	-				

NEW

Series / Série **PRO**



PRO 11



PRO 21



PRO 31



PRO 41



PRO 60



Conservadora expositora puerta cristal / Horizontal freezer with glass LID / Conservateur panoramique congélation

Serie / Series / Série **IL**

Aislamiento (100% libre de CFC'S), con 60 mm de espesor.
Evaporador y condensador en tubería de cobre.
Condensador libre mantenimiento.
Controlador digital.
Tapas correderas de cristal, marco calentado para evitar bloqueo de tapas.

Injected insulation [100% CFC'S free] with 60 mm thickness.
Evaporator and condensator in copper.
Free maintenance condenser. Digital controller.
Sliding glass lid, heated frame to avoid blocking of lids

Isolation [100% sans CFC `S], 60 mm d'épaisseur.
Évaporateur et condensateur avec tuyauterie en cuivre.
Thermostat réglable.
Thermomètre analogique.
Dessus portes coulissantes vitrées, encadrement chauffé pour éviter le blocage des portes vitrées.

Serie / Series / Série **CHE**

Aislamiento (100% libre de CFC'S), con 70 mm de espesor.
Evaporador y condensador en tubería de cobre.
Condensador de libre mantenimiento. Controlador digital.
Tapa correderas de cristal (Mod. TC) o tapa abatible (Mod. TA), con marco calentado para evitar el bloqueo de tapas.
Iluminación interior.

Injected insulation [100% CFC'S free] with 70 mm thickness.
Evaporator and condensator in copper.
Free maintenance condenser. Digital controller.
Sliding glass lid [TC] or lift lid [TA], heated frame to avoid blocking of lids.
Internal illumination.

Isolation [100% sans CFC'S], 70 mm d'épaisseur.
Évaporateur et condensateur avec tuyauterie en cuivre.
Condenseur en libre maintenance. Contrôleur digital.
Dessus portes coulissantes [Mod. TC] ou couvercle battant [Mod. TA], avec encadrement chauffé pour éviter le blocage des portes vitrées.
Éclairage intérieur.

MODELO/MODELE/MODÈLE	IL 1500 HC	IL 2000 HC	IL 2500 HC	CHE 1500 TC HC	CHE 2000 TC HC	CHE 1770 TC HC
Precio Price Prix						
Medidas  Measures [mm] Mesures	1550 960 780	2050 960 780	2500 960 780	1500 880 940	2000 880 940	1770 840 900
Tensión/Frecuencia Electrical data [V/Hz] Tension électrique	220V-240V/50Hz					
Material Material Matériel	Exterior e interior en chapa galvanizada revestida en PVC blanco. Exterior and interior of galvanized steel, white plastic coated. Extérieur et intérieur en tôle galvanisée en PVC blanc.					
Capacidad Capacity [L] Capacité	459	652	805	350	518	370
N° Cesta (serie/opción) N° baskets (standard/optional) N° Paniers [série/option]	[1/3]=4	[1/5]=6	[1/7]=8	0/5	0/6	n/d
Divisoria Alta-Baja Divider High-Low Diviseur Haut-Bas	-			1/1	1/1	1/1
Compresor Compressor Compresseur	2 [1/5]	2 [1/5]	2 [1/5]	2 [1/5]	2 [1/5]	2 [1/5]
Temperatura Temperature [3L1] Température	-18°C / -22°C			-18°C / -22°C		
Condensación Condensation Condenseur	Ventilada / Ventilated / Ventilée					
Evaporación Evaporation Évaporateur	Estática / Static / Statique					
Desescarche Defrost [Kg.] Dégivrage	Manual/ Manual / Manuel					Semiautomático / Semi-automatic / Semi-automatique
Consumo Consumption [Kwh/24h] Consommation	3,9	4,5	4,9	7,5	8,4	9
Potencia Power [W] Puissance	305	345	345	526	526	549
Refrigerante Refrigerant Gaz	R290					
Clase energética Energy class Classe énergétique	C	B	C	E	D	E
Opcional Optional Options	Porta precios/Carries prices/Porte prix			Porta precios/Carries prices/Porte prix		
	Barra divisoria/Divider bar/Barre de div. grille séparation			Kit unión / Union kit / Kit union		
	Cesta/Basket/Panier Cesta pequeña/Small Basket/Petit panier Cubeta plástico/Plastic Basket/Cuve plastique Divisoria alta/High Divider/Grille sépar. haute Divisoria baja/Small divider/Grille sépar. basse			Cesta / Basket / Panier		

Serie / Series / Série **IL**
 Serie / Series / Série **CHE**

+Info: www.infrico.com



IL2000HC









CHE2000TCHC(4) + CHE1770TCHC

CHE 1770 TC HC

TC: Tapa corredera
 TC: Sliding lid
 TC: Couvercle coulissant



Conservadora expositora puerta cristal curvada / Conservative of curved glass crystal door / Conservateur panoramique pour surgelés

MODELO MODELE MODÈLE							
	EHC1500 DEHC	EHC2000 DEHC	EHC2200 DEHC	EHC2500 DEHC	EHC1970 DETHC	EHCD2150 DEHC	EHCD1470 DEHC
Precio Price Prix							
Temperatura Temperature Température	-16°C/-24°C						
MOD.	EHC1500 DEHC	EHC2000 DEHC	EHC2200 DEHC	EHC2500 DEHC	EHC1970 DET HC		
Precio Price Prix	MIXTO MIXTE MIXTE						
Temperatura Temperature Température							
Medidas Measures Mesures							
Clase Climática Climatic class Classe climatique							
Tensión/Frecuencia Electrical data Tension électrique							
Controlador Controller Régulateur							
Material Material Matériel							
Aislamiento Isolation Isolation							
Capacidad Capacity Capacité							
Compresor Compressor Compresseur							
Nº Cesta [serie/opción] Nº baskets [standard/optional] Nº Paniers [série/option]							
Divisoria [serie/opción] Divider [standard/optional] Diviseur [série/option]							
Condensación Condensing Condensation							
Desescarche Defrost Dégivrage							
Evaporación Evaporation Évaporation							
Potencia Power Puissance							
Potencia frig. Cooling capacity Puissance Frig.							
Consumo Consumption Consommation							
Clasif. energética Energy classifc. Classif. énergétique							
Refrigerante Refrigerant Gaz							
Opcional Optional Options							

Serie / Series / Série **EHC / EHC D**
 Serie / Series / Série **EHC R**



Decor. Interior / Exterior
Interior Decor. / Exterior
Décor. Intérieure / Ext.

Ral 9016 Blanco White Blanc	Negro exterior, consultar Ext. black, to consult Noir extérieur, consulter	Antracita exterior, consultar Ext. Anthracite, to consult Anthracite extérieur, consulter
--	--	---

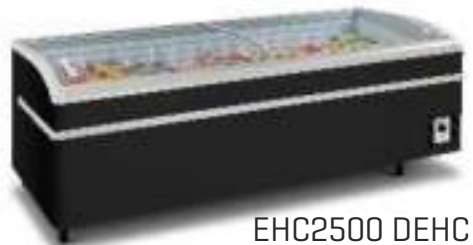
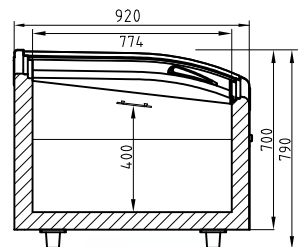

EHC2500 DEHC

Lineal ECH1970 DETHC + ECH2000 DEHC
 ECH1970 DETHC + ECH2000 DEHC Linear assembly
 Assemblage lineaire ECH1970 DETHC + ECH2000 DEHC



EHC1470 DEHC

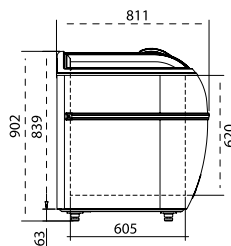
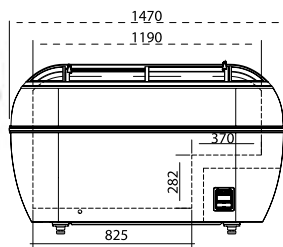

Decor. Interior / Exterior
Interior Decor. / Exterior
Décor. Intérieure / Ext.

Ral 9016 Blanco White Blanc	Negro exterior, consultar Ext. black, to consult Noir extérieur, consulter	Antracita exterior, consultar Ext. Anthracite, to consult Anthracite extérieur, consulter
--	--	---



Lineal EHCD2150 DEHC
 EHCD2150 DEHC Linear assembly
 Assemblage lineaire EHCD2150 DEHC

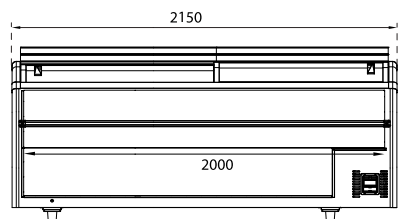
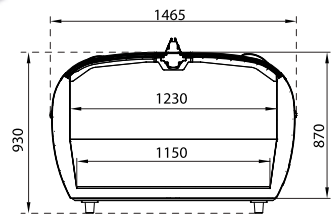

Armario de refrigeración y congelación / Chillers and freezers / Congélateur vertical

A DESTACAR

Modelos con puerta ciega SD con tirador integrado en la puerta (RV200ISD y FS200ISD) y modelos con puerta de cristal GD con tirador en acero inoxidable (RV200IGD y FS200IGD).

Puerta de cristal con doble cristal en los modelos de refrigeración, triple cristal templado y calefactado en los modelos de baja temperatura.

Modelos de refrigeración RV con dos estantes regulables y modelos de congelación FS dos estantes no regulables.

Termostato digital.

Cerradura con llave de serie.

Iluminación Led en el modelo de refrigeración con puerta de cristal.

Reguladores en la parte frontal y rodillo en la parte trasera para facilitar el desplazamiento.

BENEFITS

Models with blind door SD with integrated door handle (RV200ISD and FS200ISD) and models with glass door GD with handle in stainless steel (RV200IGD and FS200IGD).

Glass door with double glazing in the cooling models, triple tempered glass and heated in the low temperature models.

RV refrigeration models with two adjustable shelves and FS freezing models, two non-adjustable shelves.

Digital thermostat.

Lock with serial key.

LED lighting in the cooling model with glass door.

Regulators on the front and roller on the back for easy movement.

À SOULIGNER

Modèles avec porte pleine SD avec poignée intégrée dans la porte (RV200ISD et FS200ISD) et modèles avec porte vitrée GD avec poignée en acier inoxydable (RV200IGD et FS200IGD).

Porte avec double vitrage dans les modèles de réfrigération, triple vitrage avec verre trempé et chauffée dans les modèles à basse température.

Modèles de réfrigération RV avec deux niveaux réglables et modèles de congélation FS, deux niveaux non réglables.

Thermostat numérique.

Serrure avec clé de série.

Éclairage Led pour les modèles de réfrigération avec porte vitrée.

Régulateurs frontal et petits rouleaux à l'arrière pour faciliter le déplacement.

MODELO/MODELE/MODÈLE	RV 200 ISD	RV 200 IGD	FS 200 ISD	FS 200 IGD
Precio Price Prix				
Medidas Measures [mm] Mesures	600 620 835	600 620 835	600 620 835	600 620 835
Tensión/Frecuencia Electrical data [V/Hz] Tension électrique	230V / 50Hz			
Material Material Matériel	Exterior en acero inoxidable e interior en termoconformado ABS. Exterior in stainless steel and interior in ABS thermoformed. Extérieur en acier inoxydable et intérieur en thermoformage ABS.			
Capacidad Capacity [L] Capacité	150	150	150	150
Estantes Shelves Étagères	2 regulables en altura 2 height adjustable 2 réglables en hauteur	2 regulables en altura 2 height adjustable 2 réglables en hauteur	2 fijas 2 fijas 2 fijas	2 fijas 2 fijas 2 fijas
Medidas estantes Shelves dimens. [mm] Mesures étagères	410x500		450x500	
Puerta Door Porte	Ciega / Solid	Cristal / Glass	Ciega / Solid	Cristal / Glass
Temperatura Temperature [32°C] Température	0°C / +8°C	+2°C / +8°C	-18°C / -21°C	-18°C / -21°C
Condensación Condensation Condenseur	Estática / Static / Statique			Estática con ventilador Static with cooler Statique avec ventilateur
Evaporación Evaporation Évaporateur	Ventilado / Ventilated / Ventilé Roll-bond		Estática / Static / Statique	
Desescarche Defrost [Kg.] Dégivrage	Automático / Automatic / Automatique		Manual / Manual / Manuel	
Consumo Consumption [Kwh/24h] Consommation	1,7	3,2	1,66	2,8
Potencia Power [W] Puissance	140	140	80	150
Refrigerante Refrigerant Gaz	HC R600a			R290
Opcional Optional Options	-			

Serie / Series / Série **MINI ARMARIO**

+Info: www.infrico.com



RV200ISD



RV200IGD



FS200ISD



FS200IGD

Cerradura
Door lock
Serrure



Interruptor
Switch
Interrupteur



Control digital
Digital control
Contrôle digital



Congelador vertical / Freezer / Congélateur vertical

A DESTACAR

Aislamiento en poliuretano inyectado a alta presión [100% libre de CFC'S], con 55 mm de espesor.

Los modelos CV 130HC de serie con parrillas, el resto de modelos de serie con cajones extraíbles.

Panel de mandos [Termostato HC, piloto red, piloto alarma e interruptor congelación rápida].

BENEFITS

Injected polyurethane isolation to high pressure [100% free one of CFC'S], with 55 mm thickness.

Models CV 130 HC of the series with grills, the rest of models of series with removable drawers.

Control panel [Thermostat, pilot network, pilot alarm and fast freeze switch].

À SOULIGNER

Isolation en polyuréthane injecté à haute pression [100% sans CFC'S], avec 55 mm d'épaisseur.

Les modèles CV 130 HC sont de série avec grilles, les autres modèles sont avec tiroirs amovibles de série.

Panneau de commande [Thermostat, réseau pilote, alarme pilote et interrupteur congélation rapide].

Dans des modèles CV 220 et CV 330 ouverture de porte 135° pour extraction tiroirs.

MODELO/MODELE/MODÈLE	CV 130 HC CV 130 I HC	CV 220 HC	CV 330 HC
Precio Price Prix			
Medidas Measures [mm] Mesures	540 600 870	540 600 1340	540 600 1920
Tensión/Frecuencia Electrical data [V/Hz] Tension électrique	220-240/50		
Material Material Matériel	Exterior chapa plastif. blanca [CV130IHC en chapa inox]. Interior termoconformado Exterior white plastic-coated sheet [CV130IHC in stainless steel inox]. Thermoformed interior Extérieur plastifié blanc [CV130IHC en tôle inox.] Intérieur thermoformé		
Capacidad Capacity Capacité	112	157	233
Estantes Shelves Étagères	3+1	7	9 [2 abatibles]
Temperatura Temperature [32°C] Température	-18°C / -23°C		
Condensación Condensation Condenseur	Estática / Static / Statique		
Evaporación Evaporation Évaporateur	Estática / Static / Statique		
Desescarche Defrost [Kg.] Dégivrage	Manual/ Manual / Manuel		
Compresor Compressor Compresseur	1/9	1/6	1/9+1/8
Potencia Power [W] Puissance	80	110	80+100
Capacid. congelación Freezing capacity [Kg/24h] Pouvoir congélation	7	12	24
Refrigerante Refrigerant Gaz	HC R600a		
Opcional Optional Options	CV130 I HC 4 cajones / 4 drawers / 4 tiroirs:	Apertura puerta 135° para extracción de cajones. Door opening 135° for extraction of drawers. Ouverture de porte 135° pour extraction de tiroirs.	Chapa color inox. Plate color inox Tôle couleur inox. Apertura puerta 135° para extracción de cajones. Door opening 135° for extraction of drawers. Ouverture de porte 135° pour extraction de tiroirs.

Serie / Series / Série **CV**

+Info: www.infrico.com



CV 130 INOX HC

Parrillas
Grills
Grilles



Cajones en opción
Drawers optional
Tiroirs en option

Puertas abatibles
Tilt forward doors
Portes battantes



CV 330 HC

[9 cajones]
[9 drawers]
[9 tiroirs]



CV 220 HC

[7 cajones]
[7 drawers]
[7 tiroirs]

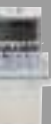

Armario expositor heladería y pastelería / Exhibiting cupboard for ice-cream and pastry / Armoire d'exposition pour la glace et la pâtisserie

A DESTACAR

Exposición de 1 a 4 caras en cristal.
Estantes interiores en cristal de 530x450 mm [Mod. L03505, L03702, L07700].
Evaporador estático de 5 niveles en armarios heladería [L03500/3700/7703].
Estantes giratorios de diámetro 460 mm [Mod. L03701].
Ruedas en todos los modelos.
Iluminación interior LED.

BENEFITS

Four face glass exhibition.
Interior shelves in glass of 530x450 [Mod. L03505, L03702, L07700].
5-level static evaporator in ice cream cabinets [L03500/3700/7703].
Rotating shelved with a 460 diameter [Mod. L03701].
Castors in all of the models.
LED lighting.

À SOULIGNER

Quatre faces vitrées.
Étagères intérieures vitrées, 530x450mm [Mod. L03505, L03702, L07700].
Évaporateur statique à 5 niveaux dans les armoires à glace [L03500/3700/7703].
Étagères tournantes 460mm [Mod. L03701].
Roulettes sur tous les modèles.
Éclairage intérieur LED.

HELADERÍA / ICE-CREAM / GLACE



L03500



L03700

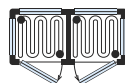

L07703



L03505



L03702



L03701

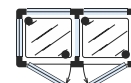

L07700

PASTELERÍA / PASTRY / PÂTISSERIE

MODELO/MODELE/MODÈLE	L03500	L03700	L07703	L03505	L03702	L03701	L07700
Precio Price Prix							
Medidas Measures (mm) Mesures	700 650 1900	700 650 1900	1320 650 1900	700 650 1900	700 650 1900	700 650 1900	1320 650 1900
Tensión/Frecuencia Electrical data [V/Hz] Tension électrique	220/50						
Material Material Matériel	Estructura en aluminio anodizado con decoración de serie en Plata. Anodised aluminium structure with round forms, and with silver series decorations. Structure en aluminium anodisé avec décoration en argent de série.						
Capacidad Capacity Capacité	420	420	420+420	420	420	420	420+420
Caras de cristal Glass sides Faces vitrées	1	4	4	1	4	4	4
Puertas Doors Portes	1	1	2	1	1	1	2
Estantes Shelves Étagères	5 fijos + 1 móvil 5 fixed + 1 mobile 5 fixes + 1 amovible		5+5 fijos + 1+1 móvil 5+5 fixed + 1+1 mobile 5+5 fixes + 1+1 amovible	5 móvil 5 mobile 5 amovible	5 móvil 5 mobile 5 amovible	6 giratorios 6 rotating 6 tournantes	5+5 móvil 5+5 mobile 5+5 amovible
Temperatura Temperature (30°C) Température	-15°C / -24°C			+2°C / +10°C (40%-60% HR)			
Condensación Condensation Condenseur	Ventilada / Ventilated / Ventilée						
Evaporación Evaporation Évaporateur	Estática / Static / Statique						
Desescarche Defrost (Kg.) Dégivrage	Manual/ Manual / Manuel			Automático / Automatic / Automatique			
Compresor Compressor Compresseur	1/2	1/2	1/2 + 1/2	1/4	1/4	1/4	1/4 + 1/4
Potencia Power (W) Puissance	471	511	942	365	365	395	730
Refrigerante Refrigerant Gaz	R290						
Opcional Optional Options	Acabado blanco o negro / White or black finish / Finition noir ou blanc  Largo / wide / Longueur 700: Largo / wide / Longueur 1320:						

Serie / Series / Série **LO**

+Info: www.infrico.com

HELADERÍA / ICE-CREAM / GLACE



L03500



L03700

PASTELERÍA / PASTRY / PÂTISSERIE



L03702



L07700



Armario expositor SOFT AIR pastelería [opcional chocolate y bombones] / Exhibiting cupboard pastry SOFT AIR [chocolates optional] / Armoire d'exposition pâtisserie SOFT AIR [en option pour le chocolat et les bonbons]

Línea de vitrinas con refrigeración ventilada, con régimen de temperatura -2°C a +15°C.

5 Parrillas por puerta regulables en altura de medida 530x450mm, o estantes de cristal sin incremento de precio.

Estantes interiores en rejilla cromada de 530x450mm. [mod. L03905, L03902, L07900].

Estantes giratorios de 460mm de diámetro [Lo3901].

Iluminación interior LED.

Ruedas en todos los modelos.

Line of showcases with ventilated cooling, with temperature range -2°C to +15°C.

5 Shelves adjustable in height of measurement 530x450mm, or glass shelves without supplement.

Interior shelves in chrome grille 530x450mm. [mod. L03905, L03902, L07900].

Rotating shelves 460mm diameter [Lo3901].

Interior LED lightning.

Wheels on all models.

Ligne de vitrines à refroidissement ventilée, avec régime de température -2°C à +15°C.

5 Étagères réglables en hauteur, 530x450mm, ou étagères en verre sans frais supplémentaires.

Étagères intérieures en grille chromée 530x450mm. [mod. L03905, L03902, L07900].

Étagères rotatives de 460 mm de diamètre [Lo3901].

Éclairage LED intérieur.

Roulettes sur tous les modèles.



L03905



L03902



L03901

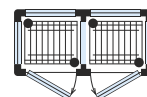

L07900

MODELO/MODELE/MODÈLE	L03905	L03902	L03901	L07900
Precio Price Prix				
Medidas Measures (mm) Mesures	700 650 1900	700 650 1900	700 650 1900	1320 650 1900
Tensión/Frecuencia Electrical data [V/Hz] Tension électrique	220/50			
Material Material Matériel	Estructura en aluminio anodizado con decoración de serie en Plata. Anodised aluminium structure with round forms, and with silver series decorations. Structure en aluminium anodisé avec décoration en argent de série.			
Capacidad Capacity Capacité	420	420	420	420+420
Caras de cristal Glass sides Faces vitrées	1	4	4	4
Puertas Doors Portes	1	1	1	2
Estantes Shelves Étagères	5	5	6 giratorios 6 rotating 6 tournantes	5+5
Temperatura Temperature (30°C) Température	-2°C / +15°C			
Condensación Condensation Condenseur	Ventilada / Ventilated / Ventilée			
Evaporación Evaporation Évaporateur	Ventilada / Ventilated / Ventilée			
Desescarche Defrost (Kg.) Dégivrage	Automático / Automatic / Automatique			
Compresor Compressor (HP) Compresseur	1/2	1/2	1/2	1/2 + 1/2
Potencia Power (W) Puissance	1014	1044	1074	1044+1044
Refrigerante Refrigerant Gaz	R290			
Opcional Optional Options	Opción chocolate y bombones / Chocolate option / Chocolate et bonbons en option Temp: +15°C / +18°C [40% / 60% HR]			
	Opción quesos / Cheese option / Option fromages			
	Acabado blanco o negro / White or black finish / Finition noir ou blanc <div style="display: flex; align-items: center; gap: 10px;"> <div style="width: 20px; height: 20px; background-color: black; border: 1px solid black;"></div> <div style="width: 20px; height: 20px; background-color: white; border: 1px solid black;"></div> </div> Largo / wide / Longueur 700: Largo / wide / Longueur 1320:			

Serie / Series / Série **LO SOFT AIR**

+Info: www.infrico.com



L07900



L03902

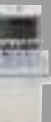

Armario expositor heladería y pastelería (No-Frost) / Exhibiting cupboard for ice-cream and pastry (No-Frost) / Armoire d'exposition pour la glace et la pâtisserie (No-Frost)

A DESTACAR

Este sistema de refrigeración permite la inserción en la misma vitrina, tanto productos de pastelería como de heladería, simplemente regulando la temperatura del termostato.

Exposición desde 1 hasta 4 caras en cristal.

Organización interior compuesta de 5 parrillas por puerta, regulables en altura, excepto el Modelo LO 3701VNP con 6 estantes giratorios en cristal.

Estantes interiores en rejilla cromada de 530x450 mm.

Estantes interiores en rejilla cromada de 730x450 mm. [ancho 900].

Estantes giratorios de diámetro 460 mm [Mod. LO3701VNP].

Ruedas en todos los modelos.

Iluminación interior LED.

BENEFITS

This refrigeration system allows insertion in the display of bakery products as well as ice cream, simply regulating the temperature of the thermostat.

Exhibit of 1 to 4 glass sides.

Interior organisation made up of 5 glass shelves by door, able to regulate in height, except Model LO 3701VNP with 6 rotating shelves in glass.

Interior shelves in chrome grill of 530x450 mm.

Interior shelves in chrome grill of 730x450 mm. [width 900].

Rotating shelved with a 460 diameter [Mod. LO3701VNP].

Castors in all of the models.

LED lighting.

À SOULIGNER

Ce système permet d'utiliser l'armoire, à la fois, pour pâtisserie et glaces, en modifiant simplement la température du thermostat

Quatre faces vitrées.

5 grilles par porte, réglables en hauteur sauf modèle LO3701VNP avec 6 étagères tournantes en verre.

Étagères intérieures chromées de 530x450mm.

Étagères intérieures chromées de 730x450mm. [largeur 900].

Étagères tournantes de 460 mm de diamètre [Mod. LO3701VNP].

Roulettes sur tous les modèles.

Éclairage intérieur LED.



MODELO/MODELE/MODÈLE

LO3500VNP

LO3700VNP



LO3701VNP

LO7703VNP

LO9311VNP

LO9314VNP

LO9324VNP

Precio Price Prix									
Medidas Measures [mm] Mesures	↔ ↕	700 650 1900	700 650 1900	700 650 1900	1320 650 1900	900 650 1900	900 650 1900	1720 650 1900	
Tensión/Frecuencia Electrical data [V/Hz] Tension électrique		220/50							
Material Material Matériel		Estructura en aluminio anodizado con decoración de serie en Plata. Anodised aluminium structure with round forms, and with silver series decorations. Structure en aluminium anodisé avec décoration en argent de série.							
Capacidad Capacity Capacité		420	420	420	420+420	600	600	600+600	
Caras de cristal Glass sides Faces vitrées		1	4	4	4	1	4	4	
Puertas Doors Portes		1	1	1	2	1	1	2	
Estantes Shelves Étagères		5	5	6 giratorios 6 rotating 6 tournantes	5+5	5	5	5+5	
Temperatura Temperature [30°C] Température		+5°C / -20°C							
Condensación Condensation Condenseur		Ventilada / Ventilated / Ventilée							
Evaporación Evaporation Évaporateur		Ventilada / Ventilated / Ventilée							
Desescarche Defrost [Kg.] Dégivrage		Automático / Automatic / Automatique							
Compresor Compressor Compresseur	[HP]	1	1	1	1+1	1	1	1+1	
Potencia Power [W] Puissance		912	952	982	1824	865	905	1730	
Refrigerante Refrigerant Gaz		R290							
Opcional Optional Options		Acabado blanco o negro / White or black finish / Finition noir ou blanc  Largo / wide / Longueur 700: Largo / wide / Longueur 1320:				Acabado blanco o negro / White or black finish / Finition noir ou blanc  Largo / wide / Longueur 900: Largo / wide / Longueur 1720:			

Serie / Series / Série **LO (No-Frost)**

+Info: www.infrico.com



LO 7703 VNP



LO 3500 VNP



L09324VNP



L09311VNP



Armario expositor para heladería / Exhibiting cupboard for ice-cream / Armoire d'exposition pour la glace

A DESTACAR

Sistema NO-FOG antiempañamiento en la puerta.
Iluminación con doble tira de LED con luz continua, mejora la visibilidad del producto expuesto.
Estantes no regulables en altura, con 4 niveles en el modelo [S] y 5 niveles en el modelo [L].
Disponible en 4 caras de cristal con terminación de serie en SILVER QUARTZ.

BENEFITS

NO-FOG anti-glare system on the door.
Double LED strip lighting with continuous light, improves the visibility of the exposed product.
Shelves not adjustable in height, with 4 levels in the model [S] and 5 levels in the model [L].
Available in 4 sides of glass with standard decoration in SILVER QUARTZ.

À SOULIGNER

Système NO-FOG dans les portes (Glaces et No-Frost).
Étagères non réglables en hauteur, 4 niveaux en modèle [S] et 5 niveaux en modèle [L].
Thermostat SOFT TOUCH avec écran graphique de 2.8" avec clavier tactile interactif.
Roulettes sur tous les modèles.
Quatre faces vitrées.
Finition standard SILVER QUARTZ.



MODELO/MODELE/MODÈLE
L06114S



L06114L



L08114S



L08114L

MODELO/MODELE/MODÈLE	L06114S	L06114L	L08114S	L08114L
Precio Price Prix				
Medidas Measures (mm) Mesures	650 650 1500	650 650 1900	850 650 1500	850 650 1900
Tensión/Frecuencia Electrical data [V/Hz] Tension électrique	220/50			
Material Material Matériel	Triple cristal sin perifería de aluminio, cristal exterior e interior bajo emisorio. Triple glass without aluminum profiles, exterior glass and low emissive interior. Triple vitrage avec verres à faible émissivité.			
Capacidad Capacity Capacité	300	450	450	600
Caras de cristal Glass sides Faces vitrées	4	4	4	4
Puertas Doors Portes	1	1	1	1
Estantes Shelves Étagères	4 fijos 4 fixed 4 fixes	5 fijos 5 fixed 5 fixes	4 fijos 4 fixed 4 fixes	5 fijos 5 fixed 5 fixes
Temperatura Temperature (30°C) Température	-15°C / -24°C			
Condensación Condensation Condenseur	Ventilada / Ventilated / Ventilée			
Evaporación Evaporation Évaporateur	Estática / Static / Statique			
Desescarche Defrost (Kg.) Dégivrage	Manual/ Manual / Manuel			
Potencia Power (W) Puissance	501	719	632	829
Refrigerante Refrigerant Gaz	R290			
Opcional Optional Options	Acabado blanco o negro / White or black finish / Finition noir ou blanc  Mod. L650mm x H1500mm: Mod. L850mm x H1500mm: Mod. L650mm x H1900mm: Mod. L850mm x H1900mm: Modelos con 1,2,3 caras de cristal. Models 1,2,3 faces of glass. Modèles avec 1,2,3 faces vitrées. Barra iluminación LED adicional Additional LED strip Éclairage LED supplémentaire. Módulo para canalizar Modular model Module canalisable.			

Serie / Series / Série **VITRA**

+Info: www.infrico.com



[850mm longitud,
altura 1900mm]
[850mm width,
height 1900mm]
[850mm longueur,
hauteur 1900mm]

Standard
[Silver quartz]

L08114L



[650mm longitud,
altura 1500mm]
[650mm width,
height 1500mm]
[650mm longueur,
hauteur 1500mm]

Standard
[Silver quartz]

L06114S



Blanco perla
White pearl
Blanc perle



Negro opal
Black opal
Noir opal



Termostato
Soft touch
Thermostat

Armario expositor para pastelería / Exhibiting cupboard for pastry / Armoire d'exposition pour pâtisserie

A DESTACAR

Iluminación con doble tira de LED con luz continua, mejora la visibilidad del producto expuesto.
Estantes de cristal regulables en altura de medida 510x450mm [mod. 650mm], y de medida 710x450mm [mod. 850mm].
3 niveles en el modelo S y 5 niveles en el modelo L. Modelo L06215S con 4 estantes de cristal giratorios.
Modelo L06215L con 6 estantes de cristal giratorios, diámetro del estante 460mm.
Disponible en 4 caras de cristal con terminación de serie en SILVER QUARTZ.

BENEFITS

Double LED strip lighting with continuous light, improves the visibility of the exposed product.
Glass shelves adjustable in height of measurement 510x450mm [mod. 650mm], and of measurement 710x450mm [mod. 850mm].
3 levels in model S and 5 levels in model L.
Model L06215S with 4 rotating glass shelves.
Model L06215L with 6 rotating glass shelves, shelf diameter 460mm.
Available in 4 sides of glass with standard decoration in SILVER QUARTZ.

À SOULIGNER

Étagères non réglables en hauteur, 4 niveaux en modèle [S] et 5 niveaux en modèle [L].
Étagères réglables en hauteur, 510x450mm [mod. 650], et 710x450 [mod. 850].
3 niveaux [mod. S], et 5 niveaux [mod. L].
Mod. L06215S avec 4 étagères tournantes en verre, et mod. L06215L avec 6 étagères tournantes en verre, 460mm Ø
Quatre faces vitrées et finition standard SILVER QUARTZ.

MODELO/MODELE/MODÈLE	L06214S	L06214L	L06215S	L06215L	L08214S	L08214L
Precio Price Prix						
Medidas Measures [mm] Mesures	650 650 1500	650 650 1900	650 650 1500	650 650 1900	850 650 1500	850 650 1900
Tensión/Frecuencia Electrical data [V/Hz] Tension électrique	220/50					
Material Material Matériel	Triple cristal sin perifería de aluminio, cristal exterior e interior bajo emisivo. Triple glass without aluminum profiles, exterior glass and low emissive interior. Triple vitrage avec verres à faible émissivité.					
Capacidad Capacity Capacité	300	450	300	450	450	600
Caras de cristal Glass sides Faces vitrées	4	4	4	4	4	4
Puertas Doors Portes	1	1	1	1	1	1
Estantes Shelves Étagères	3	5	4 giratorios 4 rotating 4 tournantes	6 giratorios 6 rotating 6 tournantes	3	5
Temperatura Temperature [30°C] Température	+2°C / +10°C					
Condensación Condensation Condenseur	Ventilada / Ventilated / Ventilée					
Evaporación Evaporation Évaporateur	Estática / Static / Statique					
Desescarche Defrost [Kg.] Dégivrage	Automático / Automatic / Automatique					
Potencia Power [W] Puissance	365	975	395	1005	365	975
Refrigerante Refrigerant Gaz	R290					
Opcional Optional Options	Acabado blanco o negro / White or black finish / Finition noir ou blanc <div style="display: flex; justify-content: center; gap: 20px;"> <div style="width: 20px; height: 20px; background-color: black; border: 1px solid black;"></div> <div style="width: 20px; height: 20px; background-color: white; border: 1px solid black;"></div> </div> Mod. L650mm x H1500mm: Mod. L650mm x H1900mm: Mod. L850mm x H1500mm: Mod. L850mm x H1900mm:					

Serie / Series / Série **VITRA**

+Info: www.infrico.com

**(650mm longitud,
altura 1500mm)**
**(650mm width,
height 1500mm)**
**(650mm longueur,
hauteur 1500mm)**



L06215S



**(650mm longitud,
altura 1900mm)**
**(650mm width,
height 1900mm)**
**(650mm longueur,
hauteur 1900mm)**

L06214L

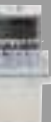

Armario expositor SOFT AIR pastelería [opcional chocolate y bombones] / Exhibiting cupboard pastry SOFT AIR [chocolates optional] / Armoire d'exposition pâtisserie SOFT AIR [en option pour le chocolat et les bonbons]

A DESTACAR

Línea de vitrinas con refrigeración ventilada, con régimen de temperatura -2°C a +15°C.

Estantes de cristal regulables en altura de medida 510x450mm, modelos de longitud 650mm y de medida 710x450mm, modelos de longitud 850mm, 3 niveles en el modelo "S" y 5 niveles en el modelo "L".

Disponible en 4 caras de cristal con terminación de serie en SILVER QUARTZ.
Iluminación interior LED.

BENEFITS

Line of showcases with ventilated cooling, with temperature range -2°C to +15°C.

Glass shelves adjustable in height of measurement 510x450mm, models of length 650mm and of measurement 710x450mm, models of length 850mm, 3 levels in model "S" and 5 levels in model "L".

Available in 4 sides of glass with standard decoration in SILVER QUARTZ.
Interior LED lightning.

À SOULIGNER

Ligne de vitrines à refroidissement ventilée, avec régime de température +15°C à +18°C.

Étagères réglables en hauteur, 510x450mm [mod. largeur 650], et 710x450 [mod. largeur 850].
3 niveaux [mod. S], et 5 niveaux [mod. L].

Quatre faces vitrées et finition standard SILVER QUARTZ.

Éclairage LED intérieur.



MODELO/MODELE/MODÈLE
L06414S



L06414L



L08414S



L08414L

MODELO/MODELE/MODÈLE	L06414S	L06414L	L08414S	L08414L
Precio Price Prix				
Medidas Measures (mm) Mesures	650 650 1500	650 650 1900	850 650 1500	850 650 1900
Tensión/Frecuencia Electrical data [V/Hz] Tension électrique	220-240/50			
Material Material Matériel	Triple cristal sin perifería de aluminio, cristal exterior e interior bajo emisivo. Triple glass without aluminum profiles, exterior glass and low emissive interior. Triple vitrage avec deux verres à faible émissivité.			
Capacidad Capacity Capacité	300	450	450	600
Caras de cristal Glass sides Faces vitrées	4	4	4	4
Puertas Doors Portes	1	1	1	1
Estantes Shelves Étagères	3	5	3	5
Temperatura Temperature (30°C) Température	-2°C / +15°C			
Condensación Condensation Condenseur	Ventilada / Ventilated / Ventilée			
Evaporación Evaporation Évaporateur	Ventilada / Ventilated / Ventilée SOFT AIR			
Desescarche Defrost (Kg.) Dégivrage	Automático / Automatic / Automatique			
Potencia Power (W) Puissance	922	922	997	997
Refrigerante Refrigerant Gaz	R290			
Opcional Optional Options	Opción chocolate y bombones / Chocolate option / Chocolate et bonbons en option Temp: +15°C / +18°C (40% / 60% HR)			
	Opción quesos / Cheese option / Option fromages			
	Acabado blanco o negro / White or black finish / Finition noir ou blanc <div style="display: flex; justify-content: space-around; align-items: center;"> <div style="display: flex; align-items: center;"> <div style="width: 15px; height: 15px; background-color: black; margin-right: 5px;"></div> Mod. L650mm x H1500mm: </div> <div style="display: flex; align-items: center;"> <div style="width: 15px; height: 15px; background-color: white; margin-right: 5px;"></div> Mod. L650mm x H1900mm: </div> <div style="display: flex; align-items: center;"> <div style="width: 15px; height: 15px; background-color: black; margin-right: 5px;"></div> Mod. L850mm x H1500mm: </div> <div style="display: flex; align-items: center;"> <div style="width: 15px; height: 15px; background-color: white; margin-right: 5px;"></div> Mod. L850mm x H1900mm: </div> </div>			

Serie / Series / Série **VITRA SOFT AIR**

+Info: www.infrico.com

**(650mm longitud,
altura 1900mm)**
**(650mm width,
height 1900mm)**
**(650mm longueur,
hauteur 1900mm)**



L06414L



L08414L

**(850mm longitud,
altura 1500mm)**
**(850mm width,
height 1500mm)**
**(850mm longueur,
hauteur 1500mm)**



Armario expositor para heladería-pastelería NO-FROST / Exhibiting cupboard for ice-cream and pastry NO-FROST / Armoire d'exposition pour la glace et la pâtisserie NO-FROST

A DESTACAR

Fabricado en triple cristal sin perfilera de aluminio, cristal exterior e interior bajo emisivo.
Sistema NO-FOG antiempañamiento en la puerta.
Iluminación con doble tira de LED con luz continua, mejora la visibilidad del producto expuesto.
Estantes de cristal regulables en altura de medida 510x450mm [mod. 650mm], y de medida 710x450mm [mod. 850mm].
3 niveles en el modelo S y 5 niveles en el modelo L.
Modelo L06315S con 4 estantes de cristal giratorios.
Modelo L06315L con 6 estantes de cristal giratorios, diámetro del estante 460mm.
Disponible en 4 caras de cristal con terminación de serie en SILVER QUARTZ.

BENEFITS

Made of triple glass without aluminum profiles, exterior glass and low emissive interior.
NO-FOG anti-glare system on the door.
Double LED strip lighting with continuous light, improves the visibility of the exposed product.
Glass shelves adjustable in height of measurement 510x450mm [mod. 650mm], and of measurement 710x450mm [mod. 850mm].
3 levels in model S and 5 levels in model L.
Model L06315S with 4 rotating glass shelves.
Model L06315L with 6 rotating glass shelves, shelf diameter 460mm.
Available in 4 sides of glass with standard decoration in SILVER QUARTZ.

À SOULIGNER

Fabriquée en triple vitrage avec deux verres à faible émissivité.
Système NO-FOG dans les portes.
Étagères non réglables en hauteur, 4 niveaux en modèle [S] et 5 niveaux en modèle [L].
Étagères réglables en hauteur, 510x450mm [mod. 650], et 710x450 [mod. 850].
3 niveaux [mod. S], et 5 niveaux [mod. L].
Mod. L06315S avec 4 étagères tournantes en verre, et mod. L06315L avec 6 étagères tournantes en verre, 460mm Ø
Quatre faces vitrées et finition standard SILVER QUARTZ.

MODELO/MODELE/MODÈLE	L06314S	L06314L	L06315S	L06315L	L08314S	L08314L
Precio Price Prix						
Medidas Measures [mm] Mesures	650 650 1500	650 650 1900	650 650 1500	650 650 1900	850 650 1500	850 650 1900
Tensión/Frecuencia Electrical data [V/Hz] Tension électrique	220/50					
Material Material Matériel	Triple cristal sin perfilera de aluminio, cristal exterior e interior bajo emisivo. Triple glass without aluminum profiles, exterior glass and low emissive interior. Triple vitrage avec deux verres à faible émissivité.					
Capacidad Capacity Capacité	300	450	300	450	450	600
Caras de cristal Glass sides Faces vitrées	4	4	4	4	4	4
Puertas Doors Portes	1	1	1	1	1	1
Estantes Shelves Étagères	3	5	4 giratorios 4 rotating 4 tournantes	6 giratorios 6 rotating 6 tournantes	3	5
Temperatura Temperature [30°C] Température	+5°C / -20°C					
Condensación Condensation Condenseur	Ventilada / Ventilated / Ventilée					
Evaporación Evaporation Évaporateur	Ventilada / Ventilated / Ventilée					
Desescarche Defrost [Kg.] Dégivrage	Automático / Automatic / Automatique					
Potencia Power [W] Puissance	833	997	863	1027	991	1415
Refrigerante Refrigerant Gaz	R290					
Opcional Optional Options	Acabado blanco o negro / White or black finish / Finition noir ou blanc <div style="display: flex; justify-content: center; gap: 20px;"> <div style="width: 20px; height: 20px; background-color: black; border: 1px solid black;"></div> <div style="width: 20px; height: 20px; background-color: white; border: 1px solid black;"></div> </div> Mod. L650mm x H1500mm: Mod. L650mm x H1900mm: Mod. L850mm x H1500mm: Mod. L850mm x H1900mm:					

Serie / Series / Série **VITRA NO-FROST**

+Info: www.infrico.com

(650mm longitud,
altura 1900mm)
(650mm width,
height 1900mm)
(650mm longueur,
hauteur 1900mm)

Negro/Black/Noir
Opcional
Optional
Option



L06314L

(650mm longitud,
altura 1900mm)
(650mm width,
height 1900mm)
(650mm longueur,
hauteur 1900mm)



L06314L

Murales calientes / Hot display cabinet / Murale d'exposition chaude

A DESTACAR

Tecnología de doble recuperación y circulación del aire caliente para un correcto mantenimiento de los productos envasados.

Sistema de cortina de aire caliente en el frontal así como en cada balda que dispone de una regulación y ventilación del aire caliente.

Costados laterales panorámicos con efecto espejo.

Tope de fijación del cristal frontal templado en cada estante para evitar la caída del producto.

Facilidad de desplazamiento al disponer de 4 ruedas, dos con freno.

Termostato digital regulable entre 20°C a 90°C para el mantenimiento del producto a temperatura reglamentaria de 63°C al corazón del producto. Norma HACCP.

Iluminación mediante tubo led en la parte posterior a ambos lados.

HDC60L: 5 Niveles de exposición en INOX [4 estantes + cuba] no regulables en altura e inclinación con superficie de exposición 580x480mm.

HDC100S: 3 Niveles de exposición en INOX [2 estantes + cuba] no regulables en altura e inclinación con superficie de exposición 980x480mm.

HDC100L: 5 Niveles de exposición en INOX [4 estantes + cuba] no regulables en altura e inclinación con superficie de exposición 980x480mm.

BENEFITS

Double recovery technology and hot air circulation for a correct maintenance of the packaged products.

Hot air curtain system on the front, as well as on each shelf, with hot air regulation and ventilation.

Panoramic side panels with mirror effect.

Tempered front glass fixing stop on each shelf to prevent the product from falling.

Easy to move as it has 4 castors, two with brakes.

Digital thermostat adjustable from 20°C to 90°C to maintain the product at the regulatory temperature of 63°C at the heart of the product. HACCP Standard.

Illumination by LED tube at the back on both sides.

HDC60L: 5 stainless steel display levels (4 shelves + tank) not adjustable in height and inclination with display surface 580x480mm.

HDC100S: 3 stainless steel display levels (2 shelves + tank) not adjustable in height and inclination with display surface 980x480mm.

HDC100L: 5 stainless steel display levels (4 shelves + tank) not adjustable in height and inclination with a 980x480mm display surface.

Á SOULIGNER

Double technologie de récupération et circulation d'air chaud pour un entretien correct des produits emballés.

Système de rideau d'air chaud à l'avant, ainsi que sur chaque étagère, avec régulation et ventilation de l'air chaud.

Panneaux latéraux panoramiques avec effet miroir.

Butée de fixation en verre trempé sur chaque étagère pour empêcher le produit de tomber.

Facile à déplacer car il possède 4 roues, dont deux avec freins.

Thermostat numérique réglable de 20°C à 90°C pour maintenir le produit à la température réglementaire de 63°C au cœur du produit. Norme HACCP.

Illumination par tube LED à l'arrière, sur les deux côtés.

HDC60L : 5 niveaux d'affichage INOX [4 étagères + réservoir] non réglables en hauteur et en inclinaison avec une surface d'affichage de 580x480mm.

HDC100S : 3 niveaux d'affichage INOX [2 étagères + réservoir] non réglables en hauteur et en inclinaison avec surface d'affichage 980x480mm.

HDC100L : 5 niveaux d'affichage INOX [4 étagères + réservoir] non réglables en hauteur et en inclinaison avec surface d'affichage 980x480mm.



HDC 60 L



HDC 100 S



HDC 100 L

MODELO/MODELE/MODÈLE	HDC 60 L	HDC 100 S	HDC 100 L
Precio Price Prix			
Medidas Measures [mm] Mesures	604 x 812 x 1973	1005 x 812 x 1529	1005 x 790 x 1970
Temperatura Temperature Température	+63°C		
Tensión/Frecuencia Electrical data Tension électrique	230/1ph/20A	400/3ph/9A	400/3ph/21A
Material Material Matériel	Exterior: acero lacado negro / Interior: acero Inox / Trasera: Inox sin puerta Exterior: black lacquered stainless / Interior: stainless steel / Back: stainless steel without door. Extérieur: acier laqué noir / Intérieur: acier inox / Arrière: acier inox sans porte		
Niveles de exposición Exposure levels Niveaux d'exposition	5	3	5
Iluminación Lighting Éclairage	Barras laterales en Led / Led sidebars / Barres laterales Led		
Control temperatura Temp. control Contrôle de la températ.	Digital		
Consumo instantáneo Instant. consumption Consommation instant.	4,5	6,3	8,3
Consumo medio Average consumption Consommation moyenne	2,3	3,1	4,1
Opcional Optional Options	Opción 60Hz		

NEW

Series / Série **HDC**

HDC 100 L



HDC 100 S



Doble recuperación y circulación del aire caliente

Double recovery technology and hot air circulation

Double technologie de récupération et circulation d'air chaud

Doble iluminación lateral LED
LED light at the back on both sides

Double éclairage LED à l'arrière, sur les deux côtés



HDC 60 L

Horno microondas profesional / Professional microwave oven / Four micro-ondes professionnel

A DESTACAR

Capacidad útil 34L. Para bandejas GN 2/3 y platos de gran diámetro.

HM1001M: Dispone de dial temporizador electrónico con función AutoReset, manual sin programas. 5 niveles de potencia. Guía de menú para elementos de uso frecuente.

HM1401P / HM1802P: Modelos digitales de membrana táctil. Funcionamiento manual o con programas. 5 niveles de potencia y 3 etapas de cocción. Tiempo de cocción máximo de 60 minutos y 100 programas automáticos. Opción de ingreso de tiempo y botón de cantidad múltiple x2 que permite cocinar diferentes porciones.

HM1001M y **HM1401P** con magnetrón y antena giratoria inferior.

HM1802P con dos magnetrones, dos antenas giratorias inferior y superior. Iluminación de la cámara. Señal acústica de final de ciclo de cocción. Posibilidad de montaje apilado de dos microondas [x2].

Filtro de aire en la parte frontal.

BENEFITS

Useful capacity 34L. GN 2/3 trays or large diameter plates.

HM1001M: 6 minute electronic timer dial with AutoReset function, manual without programs. 5 power levels by turning the dial counterclockwise. Menu guide for frequently used items.

HM1401P / HM1802P: Digital models of touch membrane. Manual operation or with programs. 5 power levels and three cooking stages. Maximum cooking time of 60 minutes and 100 automatic programs. Time entry option and multiple quantity button x2 that allows cooking different portions.

HM1001M / HM1401P with a magnetron, with a lower rotating antenna.

HM1802P with two magnetrons, with two lower and upper rotating antennas. Camera lighting. Acoustic signal at the end of the cooking cycle. Possibility of stacking two microwaves [x2]. Front air filter.

À SOULIGNER

Capacité utile 34L. Plateaux GN 2/3 ou des plaques de grand diamètre.

HM1001M: minuterie électronique, 6 minutes avec AutoReset, manuel sans programmes. 5 niveaux de puissance. Notice des différents menus pour les éléments les plus fréquemment utilisés.

HM1401P/HM1802P: Mod. numériques à membrane tactile à fonctionnement manuel ou programmable. 5 niveaux de puissance, 3 niveaux de cuisson. Temps de cuisson maximum de 60 minutes et 100 programmes automatiques. Option: saisie du temps et bouton qui multiplie par 2 la quantité permettant de cuire différentes portions.

HM1001M/HM1401P avec magnétron et antenne rotative inférieure.

HM1802P Deux magnétrons, deux antennes rotatives inférieures et supérieures. Eclairage intérieur. Alarme de fin de cycle. Possibilité de superposer 2 micro-ondes. Filtre à air frontal.

MODELO/MODELE/MODÈLE	HM1001M	HM1401P	HM1802P
Precio Price Prix			
Medidas Measures [mm] Mesures	EXT: 553x488(494)x343 INT: 370x385x230	EXT: 553x488(494)x343 INT: 370x385x230	EXT: 574x528(535)x368 INT: 360x409x225
Tensión/Frecuencia Electrical data [V/Hz] Tension électrique	220/50		
Material Material Matériel	Ext/Int: acero inoxidable Ext/Int: stainless steel Ext/Int: acier inoxydable		
Magnetrones Magnetrons Magnétrons	1	1	2
Niveles potencia Power levels Niveaux de puissance	5	5	5
Etapas de cocción Cooking stages Étapes de la cuisson	1	3	3
Tipo de control Control type Type de contrôle	Dial / Dial / Cadran	Membrana Táctil /Tactil membrane / Membrane tactile	
Descongel. por tiempo Defrosting by time Dégivrage par le temps	No	Sí/Yes/Oui	
Opción ingreso tiempo Time input option Option de saisi des temps		Sí/Yes/Oui	
Máx. tiempo cocción Max. cooking time [min] Temps cuisson max.	6	60	
Ajuste porción múltiple Multiple portion settings Possibilité plusieurs portions	No	Sí/Yes/Oui x 2	
Ajuste porción múltiple Multiple portion settings Possibilité plusieurs portions	Tiempo/Time/Temps	Tiempo-Programas/Time-Programs/Temps-Programmes	
Función cocción express Express cooking function Fonction cuisson express		Sí/Yes/Oui	
Potencia Power Puissance [W]	1000	1400	1800
Consumo Consumption Consommation [W]	1600	1900	2800
Opcional Optional Options		-	

Serie / Series / Série **MICROONDAS**

+Info: www.infrico.com



HM1001M



HM1401P

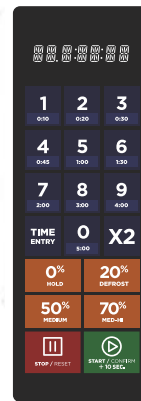

HM1802P

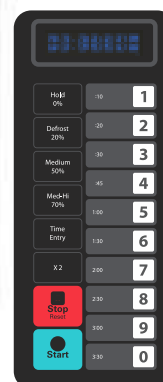

Horno eléctrico para panadería / Electric bakery oven / Fours pour la boulangerie

Serie / Series / Série **HE**

Armario caliente fermentador / Fermentation ovens / Armoire de fermentation

Serie / Series / Série **FERMENTADOR**

A DESTACAR (HE)

Puerta con doble cristal serigrafiado en color gris con tirador y apertura batiente.
Termostato seguridad.
Iluminación interior.

BENEFITS (HE)

Double glass door with grey stamped color and integrated handle.
Security thermostat.
Interior lighting.

À SOULIGNER (HE)

Porte avec double vitrage sérigraphié en gris avec poignée et ouverture à charnière.
Thermostat de sécurité.
Éclairage intérieur.

A DESTACAR (FERMENTADOR)

Puerta abatible de cristal.
Recipiente disponible para depositar agua y aportar humedad.

BENEFITS (FERMENTADOR)

Self-closing glass door.
Available water deposit and humidity kit.

À SOULIGNER (FERMENTADOR)

Porte battante en verre.
Récipient disponible pour déposer de l'eau et fournir de l'humidité.



HE304



HE424



F 848

HORNOS HE

FERMENTADOR

MODELO/MODELE/MODÈLE	HE304	HE424	HE424G	F848
Precio Price Prix				
Medidas Measures [mm] Mesures	EXT: 590x675x540 INT: 450x340x345	EXT: 640x720x540 INT: 500x410x345	EXT: 640x720x540 INT: 500x410x345	640 640 975
Tensión/Frecuencia Electrical data [V/Hz] Tension électrique	230V-50-60Hz			
Material Material Matériel	Ext/Int: acero inoxidable Ext/Int: stainless steel Ext/Int: acier inoxydable			
Temperatura Temperature Température	+50°C / +250°C			30°C / +85°C
Capacidad Capacity Capacité	4 bandejas/trays/bacs 430x340 4GN2/3	4 parrillas/shelves/grilles 480x340 4GN2/3	4 parrillas/shelves/grilles 480x340 4GN2/3	8 trays 480x340
Grill Electrical Grill Grill	-	-	Serie/Series/Série	-
Kit bandejas GN GN Trays kit Kit bacs GN	Serie/Series/Série			-
Espacio entre bandejas Shelves distance Espace entre les grilles	80 mm			-
Temporizador Timer Minuterie	0-120 min. Modo continuo / Continuous mode / Mode continu Alarma fin de ciclo / Cycle alarm / Alarme pour fin de cycle			-
Motor Engine Moteur	2			-
Potencia Power Puissance	3100W	3100W	3100W	700
Opcional Optional Options	Apertura puerta lateral / Door side opening / Ouverture porte latérale Humidificador / Humidity kit / Humidificateur Soporte horno HE424 [8 guías] / Hold up over HE424 [8 slides] / Support four HE424 [8 glissières]			-

Horno eléctrico para panadería 600x400 / Electric bakery oven 600x400/Fours pour la boulangerie 600x400

Armario caliente fermentador / Fermentation ovens / Armoire de fermentation

Serie / Series / Série HE 600x400

Serie / Series / Série FERMENTADOR

A DESTACAR (HE 600x400)

Puerta con doble cristal serigrafiado en color gris con tirador y apertura batiente. Termostato seguridad. Iluminación interior. Micro de puerta (en modelos HE604/604PLUS/HE604PLUSG).

BENEFITS (HE 600x400)

Double glass door with grey stamped color and integrated handle. Security thermostat. Interior lighting. Micro Switch on the door (models HE604/HE604PLUS/ HE604PLUSG).

À SOULIGNER (HE 600x400)

Porte avec double vitrage sérigraphié en gris avec poignée et ouverture à charnière. Thermostat de sécurité. Éclairage intérieur. Microrupteur sur la porte (modèles HE604/HE604PLUS/HE604PLUSG).

A DESTACAR (FERMENTADOR)

Puerta abatible de cristal. Recipiente disponible para depositar agua y aportar humedad.

BENEFITS (FERMENTADOR)

Self-closing glass door. Availabel water deposit and humidity kit.

À SOULIGNER (FERMENTADOR)

Porte battante en verre. Récipient disponible pour déposer de l'eau et fournir de l'humidité.



HE604



HE604PLUS

HORNOS HE 600x400



F 860

FERMENTADOR

MODELO/MODELE/MODÈLE	HE603	HE604	HE604PLUS	HE604PLUSG	F860
Precio Price Prix					
Medidas Measures [mm] Mesures	EXT: 760x800x465 INT: 620x450x270	EXT: 760x800x545 INT: 620x450x350	EXT: 760x800x545 INT: 620x450x350	EXT: 760x800x545 INT: 620x450x350	820 700 975
Tensión/Frecuencia Electrical data [V/Hz] Tension électrique	230V-50-60Hz	400/230V-50-60Hz			230V-50-60Hz
Material Matériel	Ext/Int: acero inoxidable Ext/Int: stainless steel Ext/Int: acier inoxydable				
Temperatura Temperature Température	+50°C / +250°C				30°C / +85°C
Capacidad Capacity Capacité	3 parrillas/shelves/grilles [600x400]	4 parrillas/shelves/grilles [600x400] 4GN 1/1	4 parrillas/shelves/grilles [600x400] 4GN 1/1	4 parrillas/shelves/grilles [600x400] 4GN 1/1	8 trays 600x400
Grill Electrical Grill Grill	-	-	-	Serie/Series/Série	-
Kit bandejas GN GN Trays kit Kit bacs GN	-	Serie/Series/Série			-
Espacio entre bandejas Shelves distance Espace entre les grilles	80 mm				
Temporizador Timer Minuterie	0-120 min. Modo continuo / Continuous mode / Mode continu Alarma fin de ciclo / Cycle alarm / Alarme pour fin de cycle				-
Motor Engine Moteur	1		2		-
Potencia Power [W] Puissance	3900W	5700W	6300W	6300W	1400
Opcional Optional Options	Apertura puerta lateral / Door side opening / Ouverture porte latérale Humidificador / Humidity kit / Humidificateur Soporte horno HE603/604/604PLUS / Hold up over HE603/604/604PLUS / Support four HE603/604/604PLUS				-

Invasadora al vacío de aspiración externa / External aspiration vacuum packaging machine / Machine sous vide à aspiration extérieure.

Serie / Series / Série **VACE**

A DESTACAR

Bomba auto-lubricante.

Panel de mandos digital con tres programas establecidos, proceso de embasado automático controlado electrónicamente.

Tiempo de vacío regulable, establecido a 15 y 30 segundos con posibilidad de regularlo manualmente.

Tiempo de soldadura ajustable de 1 a 7 segundos.

Vac stop permite parar en cualquier momento una fase del proceso pasando a la siguiente.

Funciona con bolsas gofradas.

BENEFITS

Self-lubricating pump.

3 programs set, automatic vacuum process controlled.

Removable vacuum time, set from 15 to 30 seconds with manual remove possibility.

Vac stop allow stop the machine in time phase of the processes.

Embossed bags.

À SOULIGNER

Pompe auto lubrifiante.

Commande digitale avec 3 programmes.

Contrôle sous vide automatique, réglé à 15 et 30 secondes avec possibilité de réglage manuel.

Temps de soudure réglable de 1 à 7 secondes.

Vac stop permet d'arrêter à tout moment une phase du processus en passant à la suivante.

Il fonctionne avec des sacs gofrés.

VACE30



VACE40

Panel de mandos digital
Digital control
Tableau de bord digital



MODELO/MODELE/MODÈLE	VACE30	VACE40
Precio Price Prix		
Medidas Measures [mm] Mesures	385x254x125	485x254x125
Tensión/Frecuencia Electrical data [V/Hz] Tension électrique	220-230/50-60Hz	
Material Material Matériel	Ext/Int: acero inoxidable AISI 304 Ext/Int: stainless steel AISI 304 Ext/Int: acier inoxydable AISI 304	
Capacidad bomba Bomb capacity Pompe à vide	20	40
Longitud soldadura Welding wide Barre de soudure	300	400
Bolsa Bag Sac	Gofrada / Embossed / Gaufré	
Potencia Power Puissance [W]	270	450
Opcional Optional Options	-	

Máquina termoselladora / Thermosealer machine / Machines thermo-soudeuses

Serie / Series / Série TSB

A DESTACAR

Sellado y corte simultaneo del film.
Sistema de frenado de retroceso del film, facilitando la colocación de las barquetas.
Modelo TSB150 incluye dos moldes:
· 1 molde para una barqueta 192x137 mm.
· 1 molde para dos barquetas 96x137 mm.
Modelo TSB 290 incluye dos moldes:
· 1 molde para una barqueta 1/2 GN [320x265 mm].
· 1 molde para dos barquetas 1/4 GN [265x162 mm].
El molde para dos barquetas esta provisto de una guía central para facilitar el corte del film.
Se suministra con bobina de film de de 300 metros de longitud y 150 mm de ancho [TSB150].
TSB290 no incluye bobina.
Profundidad máxima de la barqueta 100 mm.

BENEFITS

Cutting and welding simultaneous.
Stopping system of film regression helping the positioning.
Model TSB150 includes:
· 1 mold for 1 tank 192x137 mm.
· 1 mold for 2 tanks 96x137 mm.
Model TSB150 includes:
· 1 mold for 1 tank 1/2 GN [192x137 mm].
· 1 mold for 2 tanks 1/4 GN [265x162 mm].
The mold provide with a centred guide to help cutting the film.
Provided with Roll 300 m long and 150 mm width [TSB150].
TSB290 without roll.
Maximum depth 100 mm.

À SOULIGNER

Soudure et découpes simultanées.
Système de frein et retour du film.
Modèle TSB150 comprend:
· 1 Moule de dimensions de 192x137 mm.
· 1 Moule de dimensions de 96x 137 mm.
Modèle TSB290 comprend:
· 1 Moule pour barquettes 1/2 GN [320x265 mm].
· 1 Moule pour barquettes 1/4 GN [265x162 mm].
Le moule pour deux barquettes est équipé d'une glissière centrale pour faciliter la découpe du film.
Il est livré sur une bobine de film de 300 mètres de long et 150 mm de large [TSB150].
Le TSB290 n'a de bobine.
Profondeur maximale de la barquette: 100mm.



TSB150



TSB290

MODELO/MODELE/MODÈLE	TSB150	TSB290
Precio Price Prix		
Medidas Measures [mm] Mesures	230x500x180	380x650x180
Tensión/Frecuencia Electrical data [V/Hz] Tension électrique	220-230/50-60Hz	
Material Material Matériel	Ext/Int: acero inoxidable AISI 304 Ext/Int: stainless steel AISI 304 Ext/Int: acier inoxydable AISI 304	
Ancho bobina Roll width Largeur bobine	150	200
Potencia Power [W] Puissance	400	1400
Opcional Optional Options	[TSB 150] Bobina de longitud 150 m y ancho 150 mm Provide with Roll 150 m long and 150 mm Bobine de longueur 150 mm et largeur 150 mm.	[TSB 290] Bobina de longitud 200 m y ancho 280 mm Roll 200 m of length and 280 mm Bobine de longueur 200 mm et largeur 280 mm.

Invasadora al vacío [Tiempo] / Vacuum packaging machine [Time] / Machine sous vide [Temps]

Serie / Series / Série **VACT**

A DESTACAR

Vacuometro [excepto Mod. VACT6A]. Regulación tiempo de vacío. Regulación tiempo de soldadura. Entrada de atmósfera progresiva. Stop Vacío. Indicador luminoso del proceso activo. Modelos de sobremesa Bomba DVP de alto rendimiento. Modelos de pie Bomba Busch.

BENEFITS

Vacuum meter [except Mod. VACT6A]. Vacuum gauge time control. Sealing time control. Progressive atmosphere entry. Stop vacuum. Lighting alarm of active process. DVP pump high performance. BUSCH pump in the stand models.

À SOULIGNER

Vacuomètre [sauf mod. VACT6A]. Réglage temps sous vide. Réglage temps de soudure. Entrée d'atmosphère progressive. Arrêt sous vide. Indicateur lumineux du processus actif. Modèles à poser Pompe DVP haute performance. Modèles sur pieds avec pompe Busch.



VACT 6A



VACT 8A



VACT 12A / VACT 20A

Cuba embutida
Stamped pan
Cuve emboutie



Tapa metacrilato transparente con bisagras en acero inox
Transparent methacrylate lid with stainless steel hinges.

Couvercle transparent en méthacrylate avec charnières en inox



MODELO/MODELE/MODÈLE	MODELOS SOBREMESA / DESLTOP MODELS / MODÈLES À POSER						MOD. DE PIE / FLOOR MOD. / MOD. SUR PIED		
	VACT6A	VACT8A	VACT12A	VACT20A	VACT20B	VACT20BB	VACT40AB	VACT63AB	VACT100AB
Posición barra soldadura Sealing bar position Position barre de soudure									
Precio Price Prix									
Medidas EXT. ↔ Measures INT. ↓ Mesures	340x480x325 280x355x90	410x455x360 350x350x120	480x560x440 450x420x180	480x560x440 450x420x180	610x575x440 550x470x180	610x575x440 550x470x180	800x575x1040 680x470x200	800x575x1040 680x470x200	1000x705x1040 880x600x200
Tensión/Frecuencia Electrical data [V/Hz] Tension électrique	220-230/50-60						400/50-60		
Material Material Matériel	Ext/Int: acero inoxidable AISI 304 / Tapa metacrilato Ext/Int: stainless steel AISI 304 / Methacrylate lid Ext/Int: acier inoxydable AISI 304 / Couvercle méthacrylate								
Capacidad bomba Bomb capacity Pompe à vide	6m ³ DVP	8m ³ DVP	12m ³ DVP	20m ³ DVP	20m ³ DVP	20m ³ DVP	40m ³ BUSCH	63m ³ BUSCH	100m ³ BUSCH
Longitud soldadura Welding wide Barre de soudure	270	340	410	410	450	450	580+450	580+450	780+580
Nº Barras soldadura N. welding bars Nº barres de soudure	1						2		
Potencia Power Puissance (W)	260	350	540	750	750	750	1120	1500	2250
Opcional Optional Options	-								

Envasadora al vacío (Sensor) / Vacuum packaging machine (Sensor) / Machine sous vide (Capteur)

Serie / Series / Série VACS

A DESTACAR

50 programas. Regulación porcentual de vacío. Tiempo extra de vacío. Entrada gas inerte regulable porcentualmente. Tiempo de soldadura. Entrada de atmósfera progresiva. Programa especial para el sistema Gastro vac en los modelos de Sobremesa con Bomba DVP. Stop Vacío. Auto-calibración. Bomba Busch de alto rendimiento en modelos con pre-bomba. Entrada Gas inerte de serie. Auto-clean oil, sistema de autolimpieza del aceite de la bomba.

BENEFITS

50 programmes. Vacuum percentage control. Additional extra vacuum time. Gas entry percentage control. Sealing time control. Special gastro vac programme in with DVP pump. Stop vacuum. High performance BUSH pump in model with pump pre-install. Inert gas standard. Pre-Install gastro vac system for external countriners vacuum. Self-calibration for a perfect vacuum, providing atmosphere presion.

À SOULIGNER

50 programmes. Réglage partiel du sous vide. Temps extra du sous vide. Temps de soudure. Entrée d'atmosphère progressive. Programme spécial pour le système gastro-vac. Arrêt sous vide avec DVP. Auto-calibrage. Pompe Busch haute performance sur les modèles pré-installé. Système gastro vac pré-installé faire le vide extérieur dans des récipients Gastronorm pour les modèles à poser. Huile auto-nettoyante, système auto-nettoyant pour huile de pompe.



Barra soldadura sin conexiones con doble soldadura

Welding bar without connections and double welding

Barre de soudure sans connexion (double barres)



VACS 8A



VACS 20BB



VACS 63AB

MODELO/MODELE/MODÈLE	MODELOS SOBREMESA / DESLTOP MODELS / MODÈLES À POSER					MOD. DE PIE / FLOOR MOD. / MOD. SUR PIED		
	VACS8A	VACS10A	VACS20A	VACS20B	VACS20BB	VACS40AB	VACS63AB	VACS100AB
Posición barra soldadura Sealing bar position Position barre de soudure								
Precio Price Prix								
Medidas Measures Mesures	EXT. 410x455x360 INT. 350x350x120	480x560x440 450x420x180	480x560x440 450x420x180	610x575x440 550x470x180	610x575x440 550x470x180	800x575x1040 680x470x200	800x575x1040 680x470x200	1000x705x1040 880x600x200
Tensión/Frecuencia Electrical data [V/Hz] Tension électrique	220-230/50-60					400/50-60		
Material Material Matériel	Ext/Int: acero inoxidable AISI 304 / Tapa metacrilato Ext/Int: stainless steel AISI 304 / Methacrylate lid Ext/Int: acier inoxydable AISI 304 / Couverture méthacrylate							
Capacidad bomba Bomb capacity Pompe à vide	8m ³ DVP	10m ³ DVP	20m ³ DVP	20m ³ DVP	20m ³ DVP	40m ³ BUSCH	63m ³ BUSCH	100m ³ BUSCH
Longitud soldadura Welding wide Barre de soudure	340	410	410	450	450	580+450	580+450	780+580
Nº Barras soldadura N. welding bars Nº barres de soudure	1					2		
Potencia Power Puissance	[W] 440	540	750	750	750	1120	1500	2250
Opcional Optional Options	Gastro VAC							

Plancha a gas / Gas griddles / Plancha à gaz

Serie / Series / Série **PG**

A DESTACAR

PV:

Encendido con piezo eléctrico. Quemador en forma de herradura con doble salida de llama, logrando una temperatura uniforme en toda la placa. Orificio dispuesto en la placa con cajón recogedor de grasas integrado en el frontal. Válvulas de gas con dos intensidades de calor, máximo y mínimo. Toma de gas por el lateral izquierdo o derecho. Pies regulables en altura.

NS/NC:

Encendido tren de chispas a batería. Quemador en forma de herradura con doble salida de llama, logrando una temperatura uniforme en toda la placa. Orificio dispuesto en la placa con cajón recogedor de grasas integrado en el frontal. Válvulas de gas con dos intensidades de calor, máximo y mínimo [serie NS] y válvula de gas termostática con regulación de 100°C a 300°C. [serie Cromo duro]. Entrada de gas por la parte trasera derecha, liberando los laterales de conexiones externas. Pies regulables en altura.

BENEFITS

PV:

Electric piezo ignition. Burner with double exit flame, obtaining a uniform temperature for controlled cooking. Gas valves with two intensities of heat, maximum and minimum. Gas connection at left or right hand side. Adjustable legs. Hole in the plate with integrated grease trap drawer on the front.

NS/NC:

Ignition by sparks to battery. Burner with double exit flame, obtaining a uniform temperature for controlled cooking. Intergrated fat collection drawer in the front. Gas valves with two intensities of heat, maximum and minimum [serie NS] and thermostatic gas valves with regulation from 100°C to 300°C [serie Chromo duro]. Gas connection at the back. Adjustable feet.

À SOULIGNER

PV:

Allumage électrique. Brûleur en forme de fer à cheval avec double sortie de flamme, pour obtenir une température uniforme sur toute la plaque. Tiroir récupérateur de graisses installé en partie frontale. Valves de gaz avec deux intensités de chaleur, maximum et minimum. Entrée de gaz sur le côté gauche ou droit. Pieds réglables en hauteur.

NS/NC:

Allumage par étincelles. Brûleur en forme de fer à cheval avec double sortie de flamme, pour obtenir une température uniforme sur toute la plaque. Tiroir récupérateur de graisses installé en partie frontale. Valves de gaz avec deux intensités de chaleur, maximum et minimum [série NS] et valve de gaz thermostatique réglable de 100° à 300°C [série chrome dur]. Entrée du gaz à l'arrière droit laissant libre deux côtés externes pour les connexions. Pieds réglables en hauteur.



MODELO/MODELE/MODÈLE	PG45PV	PG60PV	PG75PV	PG90PV	PG60NS	PG80NS	PG100NS	PG60NC	PG80NC	PG100NC
Precio Price Prix										
Medidas Measures Mesures	EXT. ↔ 460 INT. ↓ 190	610 435 190	760 435 190	910 435 190	600 440 180	800 440 180	1000 440 180	600 440 180	800 440 180	1000 440 180
Material Material Matériel	Placa acero pavonado 6mm, negro Treated stainless steel plate 6 mm, black Chrome plate 15 mm, welded splashback				Placa acero laminado 15mm, peto perimetral inox Laminated steel plate 15 mm, welded splashback Chrome plate 15 mm, welded splashback			Placa en cromo duro 15mm, peto perimetral inox Chrome plate 15 mm, welded splashback Chrome plate 15 mm, welded splashback		
Kcal/h	3526	7052	7482	10922	7052	10578	12814	7052	10578	12814
Nº quemadores Nº of burners Nº brûleurs	1	2	2	3	2	3	3	2	3	3
Nº válvulas Nº of valves Nº valves	1	2	2	3	2	3	3	2	3	3
Superficie útil Usable area Surface utile	440x390	590x390	740x390	890x390	595x430	795x430	995x430	595x430	795x430	995x430
Potencia Power Puissance	(W) 4100	8200	8700	12700	8200	12300	14900	8200	12300	14900
Opcional Optional Options	-									

Plancha eléctrica / Electrical griddles / Plancha électrique

Serie / Series / Série PE

A DESTACAR

Resistencias blindadas de acero inoxidable.
Orificio dispuesto en la placa con cajón recogedor de grasas integrado en el frontal.
Termostatos con conmutador incorporado con variación de temperatura entre 50°C y 300°C.
Pies regulables en altura.

BENEFITS

Heater elements plated in stainless steel.
Intergrated fat collection drawer in the front.
Thermostat with variation of teempearture from 50°C to 300°C.
Adjustable feet.

À SOULIGNER

Résistances blindées en acier inoxydable.
Tiroir récupérateur de graisses installé en partie frontale.
Thermostats avec commutateur incorporé qui permet une variation entre 50° et 300°C.
Pieds réglables en hauteur.



MODELO/MODELE/MODÈLE	PE60PV	PE75PV	PE60NS	PE80NS	PE60NC	PE80NC
Precio Price Prix						
Medidas EXT. ↔ Measures Mesures INT. ↕	610 435 190	760 435 190	600 435 180	800 435 180	600 435 180	800 435 180
Material Material Matériel	Placa acero pavonado 6mm, negro Treated stainless steel plate 6 mm, black Chrome plate 15 mm, welded splashback		Placa acero laminado 15mm, peto perimetral inox Laminated steel plate 15 mm, welded splashback Chrome plate 15 mm, welded splashback		Placa en cromo duro 15mm, peto perimetral inox Chrome plate 15 mm, welded splashback Chrome plate 15 mm, welded splashback	
Nº quemadores Nº of burners Nº brûleurs	2	2	2	3	2	3
Nº válvulas Nº of valves Nº valves	2	2	2	3	2	3
Superficie útil Usable area Surface utile	590x390	740x390	595x430	795x430	595x430	795x430
Potencia Power Puissance	[W] 4000	4000	4000	5300	4000	5300
Opcional Optional Options	-					

Grill eléctrico / Electrical grill / Grille panini électrique

Serie / Series / Série **GR**

A DESTACAR

Todas las placas superiores son acanaladas, excepto los modelos "TL" que son lisas.
Termostato independiente regulable hasta 250°C.
Termostato de seguridad.
Señalizador luminoso, que se apaga cuando la placa ha alcanzado la temperatura deseada.
Recogedor grasas frontal.

BENEFITS

All superior plates are grooved, except the models "TL" who are smooth.
Adjustable thermostat at 250°C.
Safety thermostat.
Pilot light which turns off when reaching the desired temperature.
Frontal greases collector.

À SOULIGNER

Toutes les plaques supérieures sont rainurées, sauf les modèles "TL" qui sont lisses.
Thermostat indépendant réglable jusqu'à 250°C.
Thermostat de sécurité.
Signal lumineux, qui s'éteint quand la plaque a atteint la température souhaitée.
Tiroir récupérateur de graisses en position frontale.



GR 42



GR 82

MODELO/MODELE/MODÈLE	GR 42	GR 41 L	GR 41 LTL	GR61	GR61L	GR61LTL	GR82	GR82L	GR82LTL	GRM2
Precio Price Prix										
Medidas Measures (mm) Mesures	↔ 400 ↕ 430 ↕ 240	↔ 400 ↕ 430 ↕ 240	↔ 400 ↕ 430 ↕ 240	↔ 510 ↕ 430 ↕ 240	↔ 510 ↕ 430 ↕ 240	↔ 510 ↕ 430 ↕ 240	↔ 690 ↕ 430 ↕ 240	↔ 690 ↕ 430 ↕ 240	↔ 690 ↕ 430 ↕ 240	↔ 690 ↕ 430 ↕ 240
Tensión/Frecuencia Power supply [V/Hz] Tension/Fréquence	230/50-60									
Superf. placa inferior Surface low plate Surface plaque inférieur	255 x 245			365 x 245			550 x 245			
Temperatura Temperature [°C] Température	+30°C / +250°C									
Material Material Matériel	Estructura en acero inoxidable / Placas acanaladas o lisas de hierro fundido Stainless steel body / Flat or grooved iron plates Structure en acier inoxydable / Plaques rainurées ou lisses en fonte									
Potencia Power Puissance (W)	1800	1800	1800	3000	3000	3000	3600	3600	3600	3600
Opcional Optional Options	-									

Freidora eléctrica / Electrical fryer / Friteuse électrique

Serie / Series / Série FR

A DESTACAR

Resistencias blindadas de acero inoxidable.
Cabezal desmontable para facilitar la limpieza de la cuba.
En los modelos con grifo, cubeta con fondo inclinado para su perfecto vaciado.
Grifo de media pulgada de paso total.
Termostato regulable hasta 195°C.
Termostato de seguridad en todos los modelos.

BENEFITS

Heater covered by stainless steel.
Lift out control panel for easy cleaning.
Models with tap are equipped with slanting tank for easy empty.
Tap 1/2".
Adjustable thermostat at 195°C.
Safety thermostat in all models.

Á SOULIGNER

Résistances blindées en acier inoxydable.
Tête détachable pour un nettoyage facile du réservoir.
Pour les modèles avec robinet, cuve à fond incliné pour une vidange parfaite.
Robinet d'un demi pouce de passage total.
Thermostat réglable jusqu'à 195 ° C.
Thermostat de sécurité sur tous les modèles.



MODELO/MODELE/MOÛLE	FR 6L	FR 66L	FR 8L G	FR 88L G	FR 10L G	FR 1010L G	FR 10L GT	FR 1010L GT
Precio Price Prix								
Medidas Measures (mm) Mesures	260 355 320	520 355 320	260 395 315	520 395 315	260 445 315	520 445 315	260 445 315	520 445 315
Tensión/Frecuencia Power supply [V/Hz] Tension/Fréquence	230/50						400+N/50	
Material Material Matériel	Estructura en acero inoxidable Stainless steel body Structure en acier inoxydable							
Capacidad [Aceite] Capacity [Oil] Capacité [Huile]	6	6+6	8	8+8	10	10+10	10	10+10
Grifo Tap Robinet	No / No / Non			Sí / Yes / Oui				
Cesta Basket Panier	210x210x100	210x210x100	220x240x100	220x240x100	220x280x100	220x280x100	220x280x100	220x280x100
Nº cestas Nº baskets Nº paniers	1	2	1	2	1	2	1	2
Potencia Power Puissance	3000	3000x2	3500	3500x2	4500	4500x2	6000	6000x2

Salamandra / Salamander / Salamandre

A DESTACAR

Las salamandras completan con eficacia y en poco espacio el equipamiento de cualquier cocina, desde el snack bar hasta la restauración colectiva, tanto con menús de carne como de pescado.

Resultan indispensables en locales pequeños que sirven tapas o pinchos, como bares con almuerzos ligeros, mesas calientes, comida rápida y bocaterías, así como en las cocinas de los chefs más exigentes, que cuidan cada detalle de sus platos y preparados.

Gratinar verduras, patatas y hortalizas.
Ultimar platos al horno como lasañas, canelones y pasteles salados...
Mantener calientes platos listos para servir.



Gratinar pescados, moluscos y crustáceos.
Asar a la parrilla o acabar de hacer carnes:
hamburguesas, bistecs, salchichas y milanesas...
Caramelizar y ultimar postres.



BENEFITS

Salamanders are an efficient and space-saving addition to any kitchen, from snack bars to catering establishments, for both meat and fish menus.

They are indispensable in small establishments serving tapas or pinchos, such as light lunch bars, hot tables, fast food and snack bars, as well as in the kitchens of the most demanding chefs, who take care of every detail of their dishes and preparations.

Gratinate vegetables, potatoes and vegetables.
Finishing baked dishes such as lasagne, cannelloni and savoury pies...
Keeping ready-to-serve dishes warm.



Gratinating fish, molluscs and crustaceans.
Grilling or finishing meats:
hamburgers, steaks, sausages and breaded meats...
Caramelising and finishing desserts.



Á SOULIGNER

Les salamandres complètent de manière efficace et peu encombrante toutes les cuisines, des snack-bars aux établissements de restauration, pour les menus de viande et de poisson.

Elles sont indispensables dans les petits locaux servant des tapas ou des pinchos, tels que les bars à repas légers, les tables chaudes, les fast-foods et les snack-bars, ainsi que dans les cuisines des chefs les plus exigeants, qui soignent chaque détail de leurs plats et de leurs préparations.

Gratiner des légumes, des pommes de terre.
Finir des plats au four tels que lasagnes, cannellonis, flans, quiches...
Maintenir à température des plats prêts à servir à table.



Gratiner le poisson, les mollusques, les crustacés.
Griller ou finir la viande: hamburger, steaks, wurstel, côtelettes...
Caraméliser et finir les desserts.



	BASIC		CLÁSICA / CLASSIC / CLASIQUE		ULTRA-RÁPIDA / ULTRARAPID / ULTRA-RAPIDE		GAS / GAS / GAZ
MODELO/MODELE/MODÈLE	SE 40 BM	SE 60 BM	SE 40 M	SE 60 T	SEUF 40 M	SEUF 60 M	SG 4
Precio Price Prix							
Medidas Measures [mm] Mesures	↔ 400 ↗ 450 ↓ 500	600 450 500	400 548 500	600 548 500	400 548 500	600 548 500	750 400 460
Tensión/Frecuencia Power supply [V/Hz] Tension/Fréquence	230/50-60HZ	220-240/50-60HZ	220-240/ 50-60HZ	380-415 3N 50/60HZ	220-240/50-60HZ		
Potencia Power Puissance	2	4	2	4	2	4	7.4

NEW

Series / Série **SALAMANDRA**

+Info: www.infrico.com



BASIC



CLÁSICA /
CLASSIC /
CLASIQUE



ULTRA-RÁPIDA /
ULTRARAPID /
ULTRA-RAPIDE



GAS /
GAS /
GAZ



Tostador de túnel eléctrico / Electric tunnel toaster / Toaster à tunnel électrique

Serie / Series / Série **TTV/TTH**

A DESTACAR

Modelo TTH3000, apto para tostar, gratinar o calentar.
Modelo TTV2400 y TTV4000, apto para tostar.
Resistencias blindadas.
Selector cuatro posiciones.
Regulador velocidad cinta.
Cajón recogemigas.

BENEFITS

Model TTH3000 for toasting, browning and heating.
Model TTV2400 and TTV4000 for toasting.
Recovered heater elements on model.
Selector four positions.
Adjustable speed of the band.
Crumbs drawer.

À SOULIGNER

Modèle TTH3000, adapté pour griller, gratiner ou réchauffer.
Modèle TTV2400 et TTV4000, adapté pour grâter.
Résistances blindées.
Sélecteur quatre positions.
Régulateur vitesse de tapis.
Tiroir ramasse-miettes.



MODELO/MODELE/MODÈLE	TTV2400	TTH3000	TTV4000
Precio Price Prix			
Medidas Measures [mm] Mesures	480 510 410	750 420 250	570 620 400
Tensión/Frecuencia Power supply [V/Hz] Tension/Fréquence	230/50-60		400/ 230/50-60
Material Material Matériel	Estructura en acero inoxidable Stainless steel body Structure en acier inoxydable		
Nº resistencias Nº heater elements Nº brûleurs	2	2	2
Ancho de cinta Wide of band Largueur du tapis	260	200	360
Altura entrada alimentos Height of opening Hauteur entrée des aliments	70	70	70
Potencia Power Puissance [W]	1400+1400	1500+1500	2000+2000
Opcional Optional Options	-		

Tostador eléctrico / Electrical toaster / Toaster électrique

Serie / Series / Série T

A DESTACAR

E: Temporizador regulable 15 minutos, en los modelos T6ECT y T12ECT.

Los modelos sin temporizador T6EST y T12EST, cuentan con interruptores independientes para cada nivel de resistencias.

Dos resistencias por planta, protegidas por tubo de cuarzo de material atóxico.

Cajón recogemigas.

T6/T12:

Temporizador regulable 15 minutos.

Interruptores independientes para cada nivel de resistencias.

Tres resistencias por planta, protegidas por tubo de cuarzo de material atóxico.

Cajón recogemigas.

BENEFITS

E: Adjustable time setting up to 15 minutes, the model T6ECT y T12ECT.

Models without time setting T6EST and T12EST, have independant switches for each heater zone.

Two heater elements for each zone, quartz recovered.

Crumbs drawer.

T6/T12:

Adjustable time setting up to 15 minutes.

Independent switches for each heater zone.

Three heater elements for each zone, quartz recovered.

Crumbs drawer.

À SOULIGNER

E: Temporisateur réglable 15 minutes. Deux résistances par niveau, protégées par un tube en quartz non toxique. Tiroir ramasse-miettes.

T6/T12:

Les modèles sans temporisateur ont des interrupteurs indépendants pour chaque niveau de résistances.

Deux résistances par niveau, protégées par un tube en quartz non toxique.

Tiroir ramasse-miettes.



T6E CT



T6



T12

MODELO/MODELE/MOÛLE	T6E ST	T12E ST	T6E CT	T12E CT	T6	T12
Precio Price Prix						
Medidas Measures (mm) Mesures	480 260 240	480 260 370	480 260 240	480 260 370	525 305 325	525 305 445
Tensión/Frecuencia Power supply [V/Hz] Tension/Fréquence	230/50				230/50-60	
Material Material Matériel	Estructura en acero inoxidable Stainless steel body Structure en acier inoxydable					
Nº resistencias Nº heater elements Nº resistance	4	6	4	6	6	9
Temporizador Timer Temporisateur	No / No / Non			Sí / Yes / Oui		
Nº interruptores Nº switches Nº d'interrupteurs	2	3	0	1	2	3
Potencia Power Puissance [W]	2000	3000	2000	3000	2000	2750
Opcional Optional Options	-					

Termo de leche / Milk urns / Termo de lait

Serie / Series / Série TL

A DESTACAR

Calentador al baño María, ideal para leche, café, consomé, té, etc.
Deposito en acero inox desmontable mediante rosca.
Termostato autorregulable.
Interruptor luminoso puesta en marcha.
Grifo regulable en dos posiciones.

BENEFITS

Bain Marie heating, ideal for milk, coffee, consomme, tea, etc.
Deposit in detachable steel inox by means of spiral.
Self-regulatory thermostat.
Beginning luminous switch.
Adjustable faucet in two positions.

À SOULIGNER

Mise en température par bain-marie, idéal pour lait, café, consommé, thé, etc.
Réservoir en acier inox démontable (système à vissees).
Thermostat autoréglable.
Interrupteur lumineux mise en marche.
Robinet réglable dans deux positions.



TL 6



TL 66

MODELO/MODELE/MODÈLE	TL 3	TL 6	TL 66
Precio Price Prix			
Medidas Measures [mm] Mesures	↔ 232 ↗ 232 ↘ 430	265 265 525	525 265 525
Tensión/Frecuencia Power supply [V/Hz] Tension/Fréquence	220-230/50		
Material Material Matériel	Int/Ext: acero inoxidable AISI 304 Int/Ext: Stainless steel AISI 304 Int/Ext: acier inoxydable AISI 304		
Capacidad Capacity Capacité	[L] 3	6	6+6
Potencia Power Puissance	[W] 1000	1500	1500 +1500
Opcional Optional Options	Sujección tapa para uso como termo de chocolate. Attachment covers for use like chocolate thermus. Fixation du couvercle pour utilisation comme thermos à chocolat.		

Cortadora de fiambre / Sharpening slicers / Trancheuse professionnelle

Serie / Series / Série CS / CSCEV

A DESTACAR

Avance del producto por gravedad.
Motor ventilado profesional de transmisión por correa.
Cuchilla rectificada y cromada en cromo duro.
Espesor máximo de corte 14 - 16 mm.
Afilador fijo en la gama "S".
Interruptor marcha-paro con relé, que no permite, en caso de interrupción de la corriente, el funcionamiento de la máquina sin el rearme del mismo [GAMA SCEV].
Fácil limpieza de todos sus componentes.

BENEFITS

Professional ventilated motor.
Tempered ground hard chromium-plate professional blade.
Slizing thickness up to 14 - 16 mm.
Fixed sharpener in range "S".
Start and stop switch with relay to avoid the automatic restarting of the machine in the case of electrical power shortage [RANGE SCEV].
Easy cleaning of all components.

Á SOULIGNER

Avancée du produit par gravité.
Moteur ventilé professionnel avec transmission par courroie.
Lame concave.
Épaisseur maximale de coupe 14 - 17 mm.
Rémouleur fixe dans la gamme "S".
Interrupteur marche-arrêt avec un relais qui ne permet pas, en cas de coupure de courant, le fonctionnement de la machine sans reprogrammation [SCEV].
Nettoyage facile de tous ses composants.



C220 SCEV



C250 S



C300 SCEV



C 350 SCEV

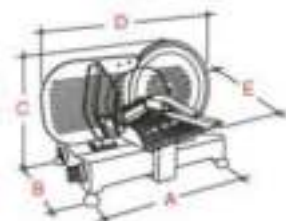

Afilador con doble esmeril.
Sharpener with double emery
Rémouleur avec double émeri.



Modelo SCEV con bloqueo de carro deslizante que permite desmontar la bandeja de alimentos y su cojinete.

Model SCEV with block of sliding carriage which allows to disassemble the food tray and its bearing
Modèle SCEV avec verrouillage du chariot coulissant qui permet de démonter le plateau à aliments et son roulement.



Prensa producto con protección en plexiglas

Food-holder arm with protection in plexiglass

Presse avec protection en plexiglas





MODELO/MODELE/MODELÉ	C 220 S C 220 SCEV	C 250 S C 250 SCEV	C 275 S -	C 300 S C 300 SCEV	- C 350 SCEV
Precio Price Prix					
Dimens. A (mm)	385	385	400	438	487
Dimens. B (mm)	245	245	250	298	355
Dimens. C (mm)	355	365	390	420	515
Dimens. D (mm)	425	475	685	520	685
Dimens. E (mm)	400	410	555	450	555
Tensión/Frecuencia Power supply [V/Hz] Tension/Fréquence	220/50				
Material Material Matériel	Estructura fundición de aluminio anodizado [C275 S aluminio lacado] Structure anodized aluminium [C275 S laquered aluminium] Structure aluminium anodisé [C275 S aluminium laqué]				
Diámetro cuchilla Diameter slicer (mm) Diamètre lame	220	250	275	300	350
Potencia Power Puissance (W)	170	190	150	250	400
Capacidad corte (mm ±S) Cutting capacity Épaisseur de tranches	200 125	195 145	225 180	245 195	280 220



infrico.com

infrico.com

Síguenos en: **in f**  

info@infrico.com

Tel: (0034) 957 51 30 68

**Ctra. de Aguilar a A-318 por Moriles, km 15,5 - A-3132
CP 14900 LUCENA, Córdoba - España**