

Typical store with cabinets prepared for connection to unit for HFC gas or Co2

Negoziò tipo con mobili collegabili a centrale remota per gas HFC o Co2

1 EXCELSIOR for cold cuts, cheese, meat and deli presented with the SPIN module in middle of the line-up. Elegance and attention to details are combined in this model with functionality and guaranteed performances, as well as the large display area, without losing a sight on the ergonomics of the shape.

EXCELSIOR per salumi, formaggi, carne e gastronomia, presentato con il modello SPIN al centro del canale. L'eleganza e la cura dei dettagli, si sposano in questo modello a funzionalità e sicurezza di prestazioni, nonché allo spazio ampio di esposizione, senza perdere di vista l'ergonomia della forma.

2 Rear wall cabinet ROMA, in remote and plug-in version, for cold cuts, cheese and not refrigerated products.

Retrobanco ROMA, gruppo a distanza o plug-in, per salumi, formaggi e prodotti non refrigerati.

3 This is UP the new wall display which you can hang on the wall to show in plain sight the products on sale

Ecco UP il nuovo espositore che si può appendere alla parete per mettere bene in vista i prodotti in vendita.

4 Wall multideck display LEM model, for drinks, snacks, promotional products and more.

Murale LEM per bibite, snack, prodotti promozionali e altro.

5 PANAREA HD BMM – promotional semi vertical island for dairy and meat products.

Isola promozionale con ripiani PANAREA HD BMM per prodotti freschi e carne impacchettata.

6 7 8 Wall multideck for fruit and vegetables VENEZIA OVERVIEW OPEN here joined to VENEZIA OVERVIEW DOORS. The OVERVIEW line offers the chance to display in one single line up different categories of products with an elegant effect and uniformity of style.

Murale VENEZIA OVERVIEW OPEN versione ortofrutta, canalizzato con VENEZIA OVERVIEW DOORS.

La nuova linea OVERVIEW offre in un unico canale differenti categorie di prodotti esposti; si ottiene così un effetto di eleganza ed uniformità di stile.

9 For the frozen products we present TORINO OVERVIEW H150 to use in the smartest way the room inside the shop with a style and the minimum sizes.

Per i prodotti surgelati presentiamo il TORINO OVERVIEW H150 che permette di utilizzare nel modo più intelligente lo spazio disponibile all'interno del negozio con stile e ingombri minimi.



HER CORNER



3

FOOD TO GO



CHILLED DRINKS
PROMO

4

5





pastorfrigor
GROUP

SERVEOVER COUNTERS

Excelsior	9
Excelsior Tower	11
Excelsior Spin	13
Admiral	15
Admiral Tower	17
Admiral Sphera	19
Excellence	21
Excellence Tower	23
Eskimo VC	25
Eskimo VDR	27
Eskimo Tower	29
Prince VDR	31
Click	33
Zita Mini	35
Linda	37
Kristina	39

MULTIDECKS

Genova Overview Doors	43
Genova Overview Open	45
Genova Overview BT	47

Genova Overview Doors H150	49
Genova Overview Doors H165	51
Lem H150	53
Lem	55
Pangea	57
Venezia Overview Open	59
Venezia Overview Doors	61
Venezia Overview Basso	63
Venezia Overview Basso Doors	65
Venezia Overview Open H150	67
Venezia Overview Doors H150	69
Venezia Overview Roll In	71
Venezia Sushi	73
Verona Overview Open	75
Verona Overview Doors	77
Roma	79
Up	81
Milano Overview	83
Torino Overview	85
Torino Overview H150	87
Sofia	89
Sara	91
Kalifornia Q	93

ISLANDS

Vulcano	97
Maui	99
Panarea HD	101
Panarea HD BMM	103
Islanda	105
Sicilia Overview	107
Capri Overview	109
Sardegna Overview Open	111
Sardegna Overview Doors	113
Conv	115
Felix Q	117
Felix SG	119

COLD ROOMS







Cold rooms	122
Cold rooms	124

Indie

















The pictures of this catalogue may not refer to the standard version and configuration. Changes and updates may be made in the future anytime and for any reason. The versions of the current production are to be considered as non-binding.

Le immagini di questo catalogo potrebbero non riferirsi all'allestimento e versione standard. Eventuali modifiche e aggiornamenti dei prodotti potranno essere apportati in futuro. Versioni della attuale produzione non vincolanti.

TECHNICAL FEATURES

	Plug-in Con gruppo incorporato
	Remote Senza gruppo incorporato
	Ventilated Refrigerazione ventilata
	Low consumption fans Ventole a basso consumo
	LED lighting Illuminazione LED
	Off-cycle defrost Sbrinamento a fermata
	Electric defrost Sbrinamento elettrico
	Antifog ventilation Ventilazione antiappannante
	Antifog heater Resistenza anticondensa
	Propane refrigerant gas R290 Refrigerante R290

COMMERCIAL CATEGORIES

	Sausages & Salami Salumi		Dry pastries and bread Pasticceria secca e pane
	Packed meat Carne confezionata		Chilled drinks Bibite fresche
	Cheese, dairy Formaggi, latticini		Beer and wine Birra e vino
	Milk Latte		Cakes and baked delicacies Torte e prodotti da forno
	Delicatessen Gastronomia		Ready meals and salads Piatti pronti e insalate
	Vegetables Verdura		Frozen food Surgelati
	Fruit Frutta		
	Snack and Sandwiches Snack e panini		
	Impulse Acquisto d'impulso		
	Food to go Cibo da asporto		

Legend





Serveover Counters

BANCHI TRADIZIONALI



Excelsior

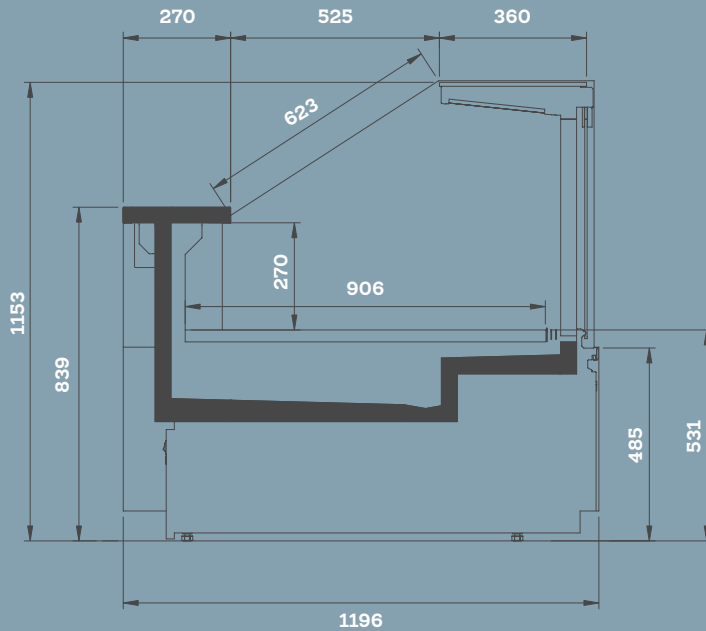

* Complete legend available on product sheets found on our websites www.pastorfrigor.it

COMMERCIAL CATEGORIES*



TECHNICAL FEATURES*



AVAILABLE DIMENSIONS*

L: 937 - 1250 - 1875 - 2500
3125 - 3750

90° INT/ EXT - 45° INT/ EXT

AVAILABLE VERSIONS*

Double Static - Doppio Statico

Hot Section - Tavola Calda

Fish - Pesce

Pastry - Pasticceria

Low Temp. - Bassa Temperatura

Bread - Pane

REFRIGERANT*

Thermostatic expansion valve
for all the refrigerant in use
Co2 Refrigeration



Excelsior Tower

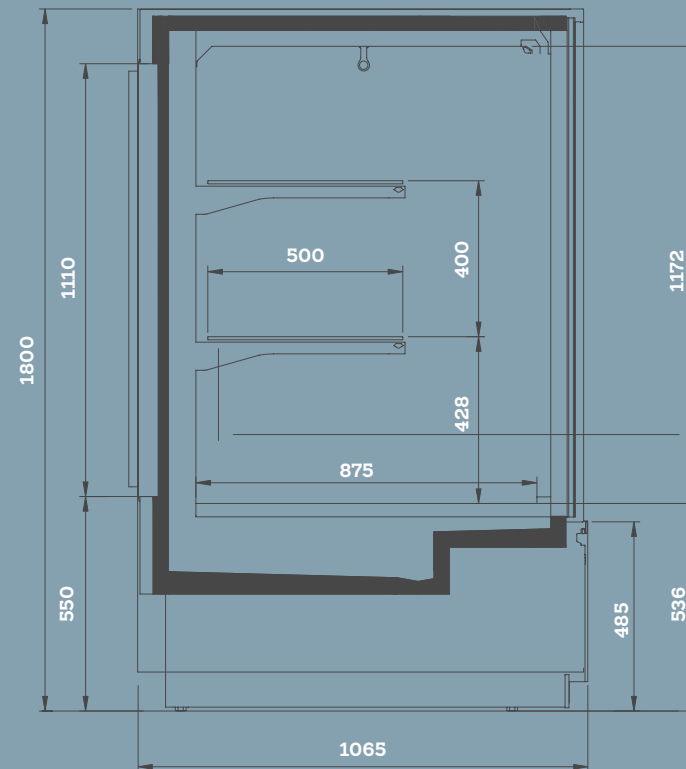

* Complete legend available on product sheets found on our websites www.pastorfrigor.it

COMMERCIAL CATEGORIES*



TECHNICAL FEATURES*



AVAILABLE DIMENSIONS*

L: 1250

REFRIGERANT*

Thermostatic expansion valve for all the refrigerant in use
Co2 Refrigeration



Excelsior Spin

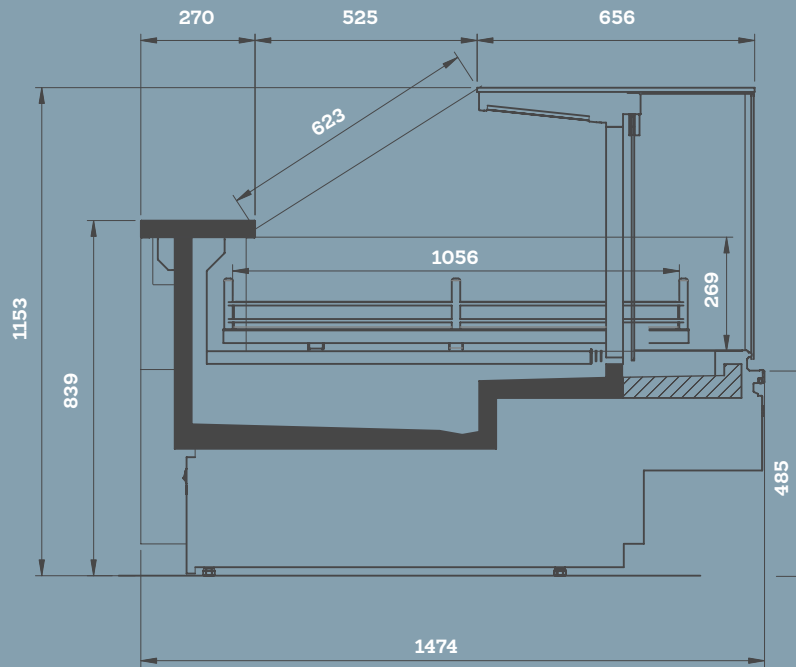

* Complete legend available on product sheets found on our websites www.pastorfrigor.it

COMMERCIAL CATEGORIES*



TECHNICAL FEATURES*



Remote



Antifog ventilation



LED lighting



Low consumption fan

AVAILABLE DIMENSIONS*

L: 1250

AVAILABLE VERSIONS*

Fish on ice - Pesce su ghiaccio

REFRIGERANT*

Thermostatic expansion valve for all the refrigerant in use
Co2 Refrigeration



Admiral

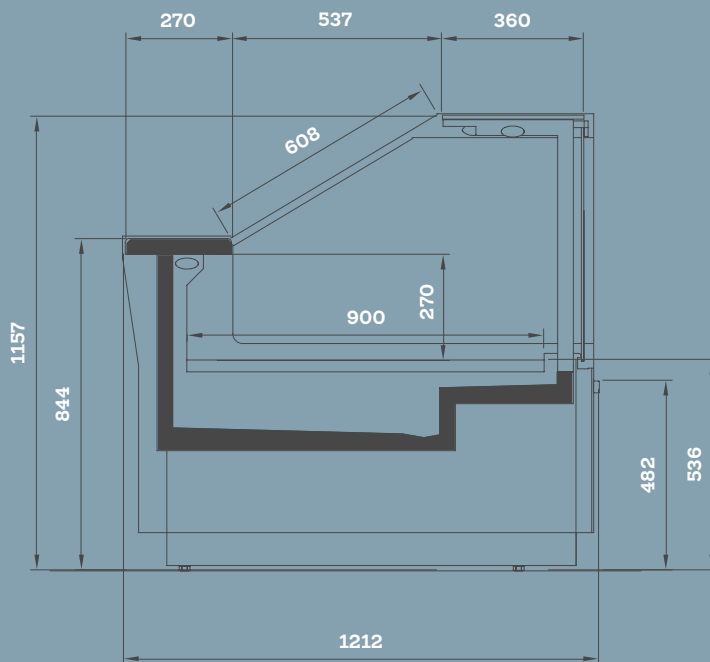

* Complete legend available on product sheets
found on our websites www.pastorfrigor.it

COMMERCIAL CATEGORIES*



TECHNICAL FEATURES*



Remote



Antifog
ventilation



LED
lighting



Low
consumption fan

AVAILABLE DIMENSIONS*

L: 937 - 1250 - 1875 - 2500

3125 - 3750

90° INT/ EXT - 45° INT/ EXT

AVAILABLE VERSIONS*

Double Static - Doppio Statico

Hot Section - Tavola Calda

Fish - Pesce

Pastry - Pasticceria

Low Temp. - Bassa Temperatura

Bread - Pane

BMM Semivertical multideck

BMM Murale semiverticale

REFRIGERANT*

Thermostatic expansion valve
for all the refrigerant in use
Co2 Refrigeration



Admiral Tower

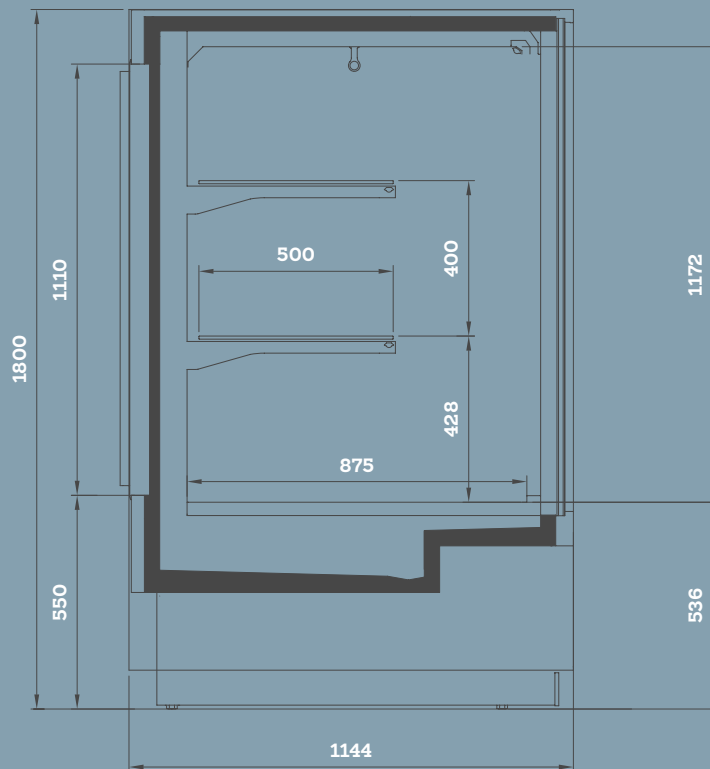

* Complete legend available on product sheets found on our websites www.pastorfrigor.it

COMMERCIAL CATEGORIES*



TECHNICAL FEATURES*



Remote



Antifog
ventilation



LED
lighting



Low
consumption fan

AVAILABLE DIMENSIONS*

L: 1250

REFRIGERANT*

Thermostatic expansion valve for all the refrigerant in use
Co2 Refrigeration

SERVEOVER COUNTERS



Admiral Sphera

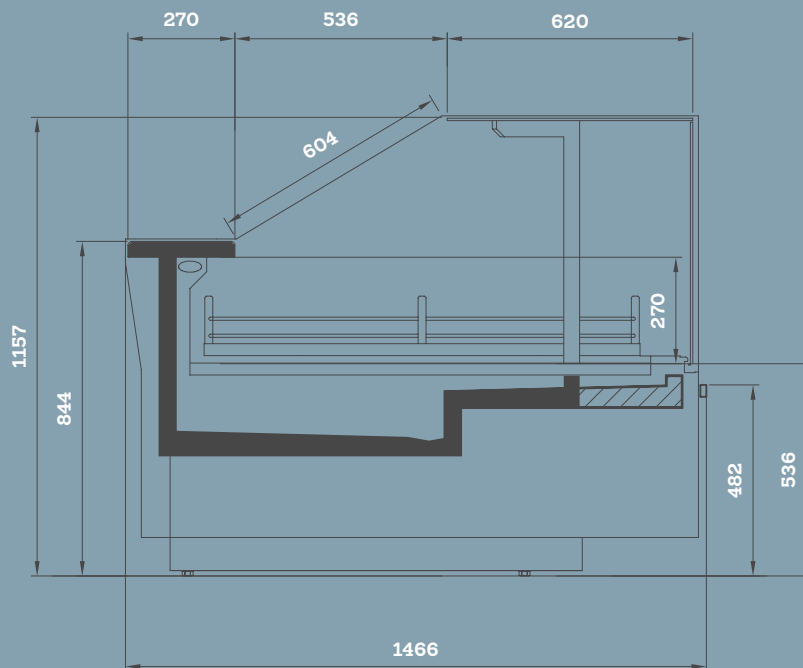

* Complete legend available on product sheets found on our websites www.pastorfrigor.it

COMMERCIAL CATEGORIES*



TECHNICAL FEATURES*



Remote



Antifog ventilation



LED lighting



Low consumption fan

AVAILABLE DIMENSIONS*

L: 1250

AVAILABLE VERSIONS*

Fish on ice - Pesce su ghiaccio

REFRIGERANT*

Thermostatic expansion valve for all the refrigerant in use
Co2 Refrigeration

Model not subject to Energy Labelling
(Ecodesign 2019/2024 and Energy Labelling 2019/2018).

Modello non soggetto ad etichettatura energetica
(Ecodesign 2019/2024 e Energy Labelling 2019/2018).



SERVEOVER COUNTERS



Excellence

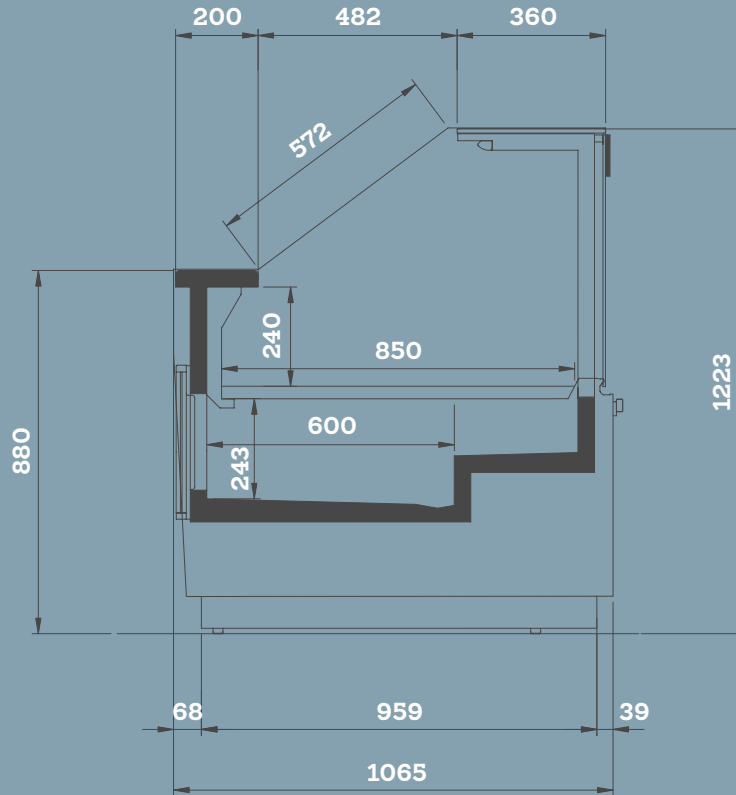

* Complete legend available on product sheets found on our websites www.pastorfrigor.it

COMMERCIAL CATEGORIES*



TECHNICAL FEATURES*

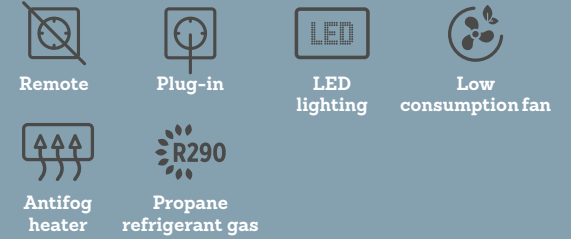

AVAILABLE DIMENSIONS*

L: 937 - 1250 - 1875 - 2500 - 3125 - 3750
90° INT/ EXT - 45° INT/ EXT

AVAILABLE VERSIONS*

Hot Section - Tavola Calda

Fish - Pesce

Pastry - Pasticceria

Low Temp. - Bassa Temperatura

Bread - Pane

Cylindrical corners - Angoli cilindrici

REFRIGERANT*

Thermostatic expansion valve for all the refrigerant in use
Co2 Refrigeration
R290 built in unit
Available with all the other refrigerant in use



Excellence Tower

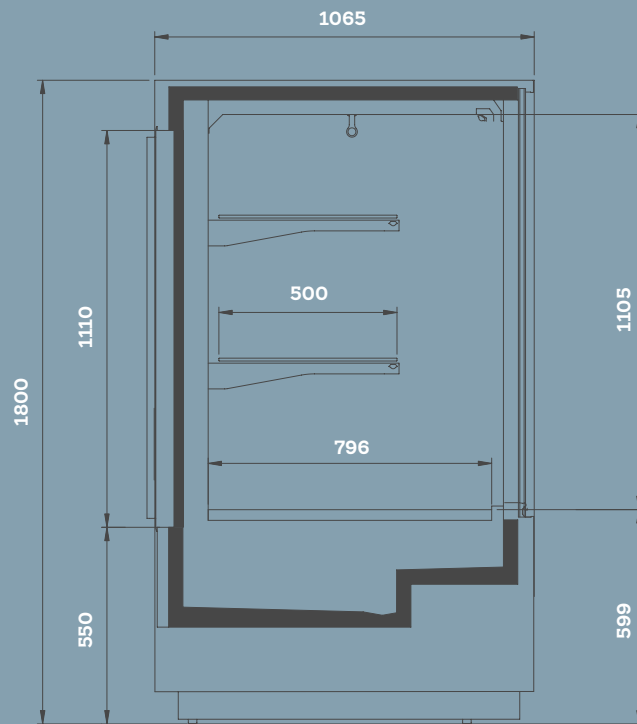

* Complete legend available on product sheets found on our websites www.pastorfrigor.it

COMMERCIAL CATEGORIES*



TECHNICAL FEATURES*



Remote



Plug-in



Antifog heater



LED lighting



Low consumption fan

AVAILABLE DIMENSIONS*

L: 1250

REFRIGERANT*

R290

Co2 Refrigeration

Model not subject to Energy Labelling
(Ecodesign 2019/2024 and Energy Labelling 2019/2018).

Modello non soggetto ad etichettatura energetica
(Ecodesign 2019/2024 e Energy Labelling 2019/2018).

SERVEOVER COUNTERS



Eskimo VC

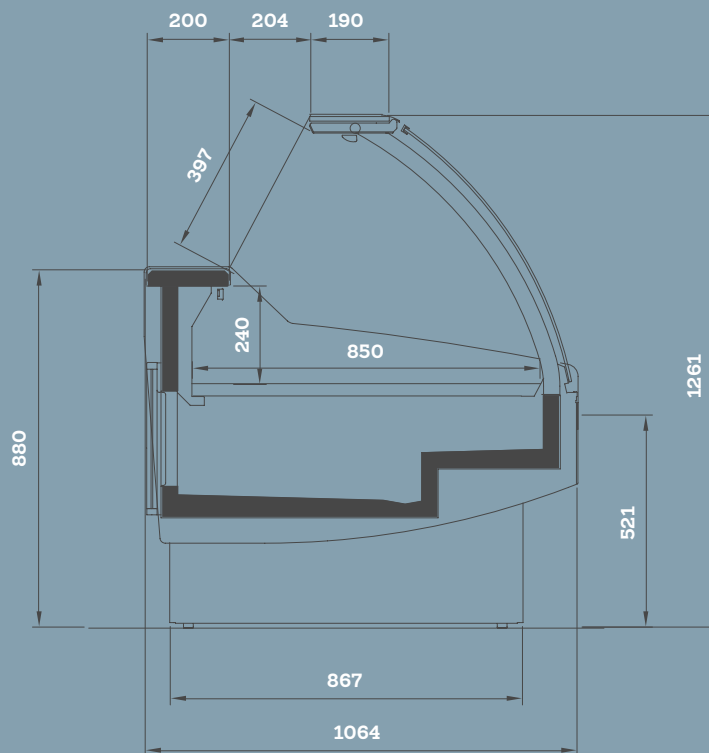

* Complete legend available on product sheets
found on our websites www.pastorfrigor.it

COMMERCIAL CATEGORIES*



TECHNICAL FEATURES*



Remote



Plug-in



LED
lighting



Low
consumption fan



Antifog
heater



Propane
refrigerant gas

AVAILABLE DIMENSIONS*

L: 937 - 1250 - 1875 - 2500 - 3125 - 3750
90° INT/ EXT - 45° INT/ EXT

AVAILABLE VERSIONS*

Hot Section - Tavola Calda

Fish - Pesce

Pastry - Pasticceria

Low Temp. - Bassa Temperatura

Bread - Pane

Spherical corners - Angoli sferici

BMM Semivertical multideck

BMM Murale semiverticale

REFRIGERANT*

Thermostatic expansion valve
for all the refrigerant in use
Co2 Refrigeration
R290 built in unit
Available with all the other
refrigerant in use

Model not subject to Energy Labelling
(Ecodesign 2019/2024 and Energy Labelling 2019/2018).

Modello non soggetto ad etichettatura energetica
(Ecodesign 2019/2024 e Energy Labelling 2019/2018).

SERVEOVER COUNTERS



Eskimo VDR

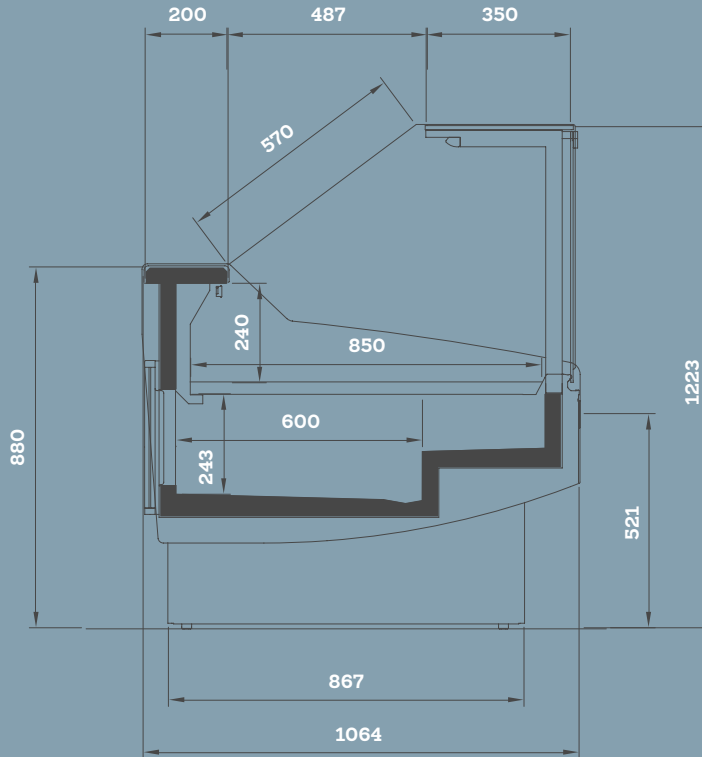

* Complete legend available on product sheets found on our websites www.pastorfrigor.it

COMMERCIAL CATEGORIES*



TECHNICAL FEATURES*

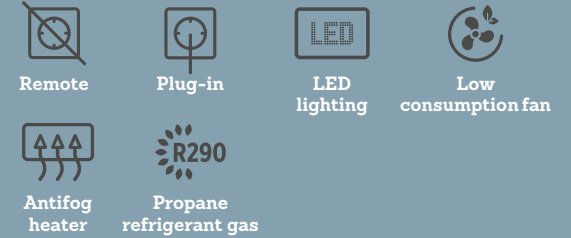

AVAILABLE DIMENSIONS*

L: 937 - 1250 - 1875 - 2500 - 3125 - 3750
90° INT/ EXT - 45° INT/ EXT

AVAILABLE VERSIONS*

Hot Section - Tavola Calda

Fish - Pesce

Pastry - Pasticceria

Low Temp. - Bassa Temperatura

Bread - Pane

Cylindrical corners - Angoli cilindrici

BMM Semivertical multideck

BMM Murale semiverticale

REFRIGERANT*

Thermostatic expansion valve for all the refrigerant in use
Co2 Refrigeration
R290 built in unit
Available with all the other refrigerant in use



Eskimo Tower

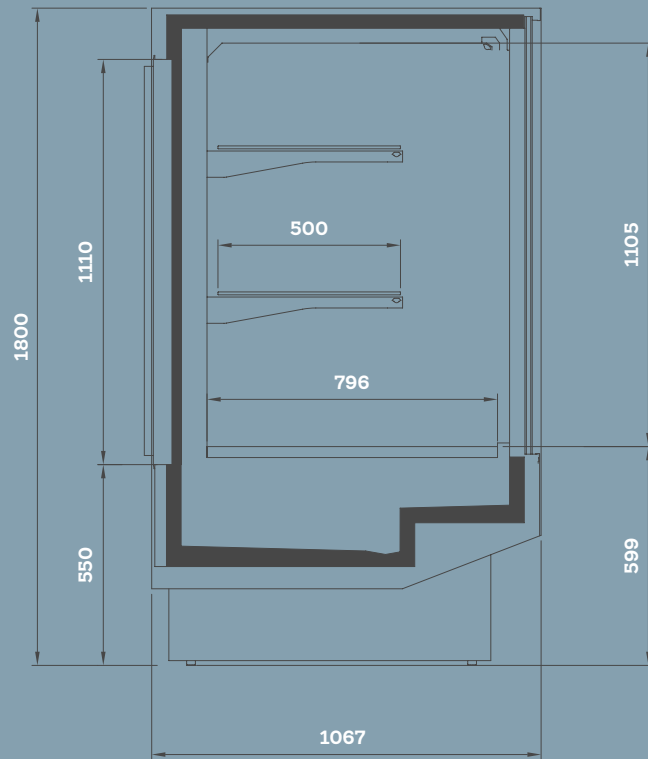

* Complete legend available on product sheets found on our websites www.pastorfrigor.it

COMMERCIAL CATEGORIES*



TECHNICAL FEATURES*



Remote



Plug-in



Antifog heater



LED lighting



Low consumption fan

AVAILABLE DIMENSIONS*

L: 1250

REFRIGERANT*

R290

Co2 Refrigeration

Model not subject to Energy Labelling
(Ecodesign 2019/2024 and Energy Labelling 2019/2018).

Modello non soggetto ad etichettatura energetica
(Ecodesign 2019/2024 e Energy Labelling 2019/2018).

SERVEOVER COUNTERS



Prince VDR

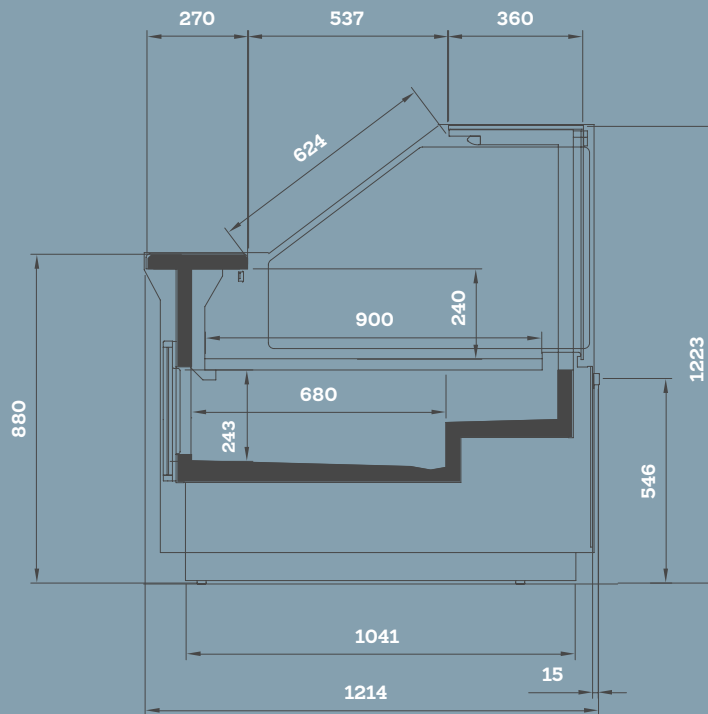

* Complete legend available on product sheets found on our websites www.pastorfrigor.it

COMMERCIAL CATEGORIES*



TECHNICAL FEATURES*

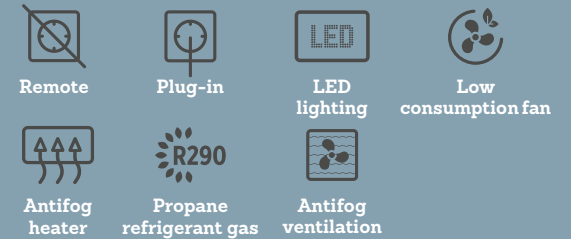

AVAILABLE DIMENSIONS*

L: 937 - 1250 - 1875 - 2500 - 3125 - 3750
90° INT/ EXT - 45° INT/ EXT

AVAILABLE VERSIONS*

Hot Section - Tavola Calda

Pastry - Pasticceria

Low Temp. - Bassa Temperatura

Bread - Pane

Cylindrical corners - Angoli cilindrici

BMM Semivertical multideck

BMM Murale semiverticale

REFRIGERANT*

Thermostatic expansion valve for all the refrigerant in use
Co2 Refrigeration
R290 built in unit
Available with all the other refrigerant in use



72 pcs 1250 loadable
on a full truck



Click

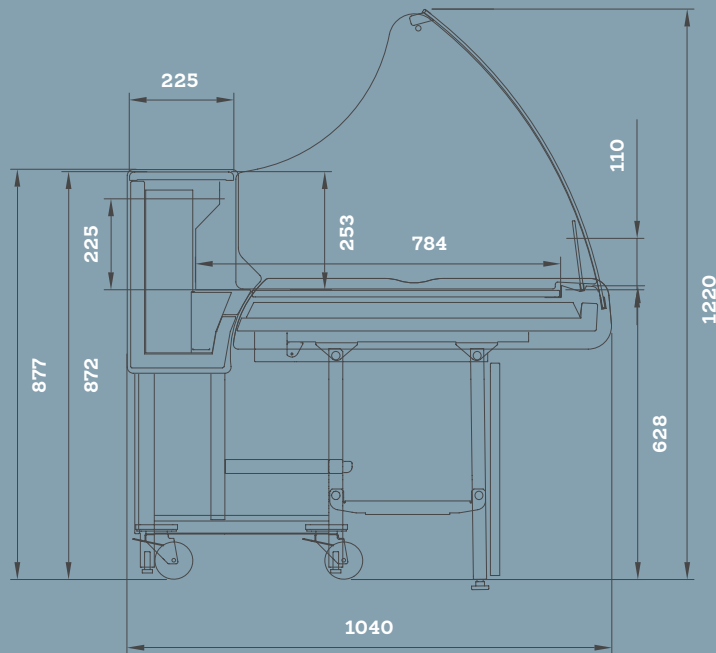

* Complete legend available on product sheets found on our websites www.pastorfrigor.it

COMMERCIAL CATEGORIES*



TECHNICAL FEATURES*



Plug-in



Low consumption fan

AVAILABLE DIMENSIONS*

L: 1250 - 1875

AVAILABLE VERSIONS*

Self service Lighting

Illuminazione

REFRIGERANT*

Thermostatic expansion valve for all the refrigerant in use
Co2 Refrigeration
R290 built in unit
Available with all the other refrigerant in use

Model not subject to Energy Labelling
(Ecodesign 2019/2024 and Energy Labelling 2019/2018).

Modello non soggetto ad etichettatura energetica
(Ecodesign 2019/2024 e Energy Labelling 2019/2018).



SERVEOVER COUNTERS



Zita Mini

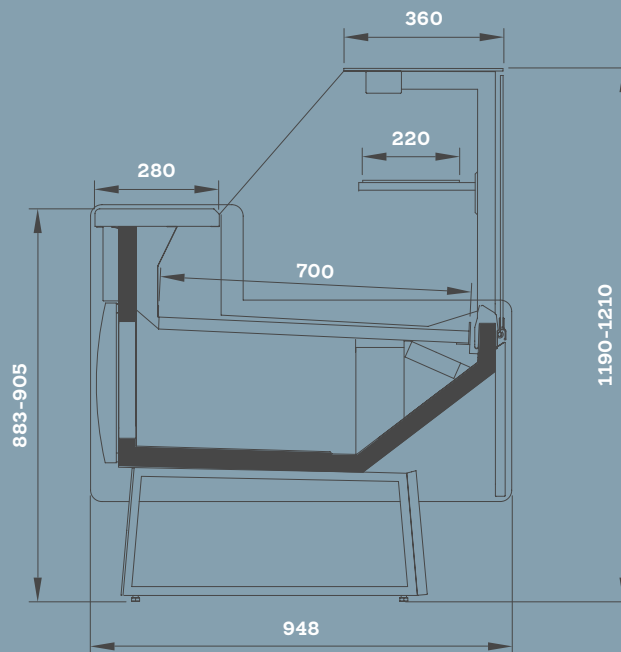

* Complete legend available on product sheets found on our websites www.pastorfrigor.it

COMMERCIAL CATEGORIES*



TECHNICAL FEATURES*



Remote



Plug-in



Ventilated



Propane
refrigerant gas

AVAILABLE DIMENSIONS*

L: 937 - 1250 - 1875 - 2500 - 3125

90° INT/ EXT - 45° INT/ EXT

AVAILABLE VERSIONS*

Hot section - Tavola calda

Bread - Pane

REFRIGERANT*

Thermostatic expansion valve for all the refrigerant in use
R290 built-in unit refrigerant

Linda



Linda Q



Linda

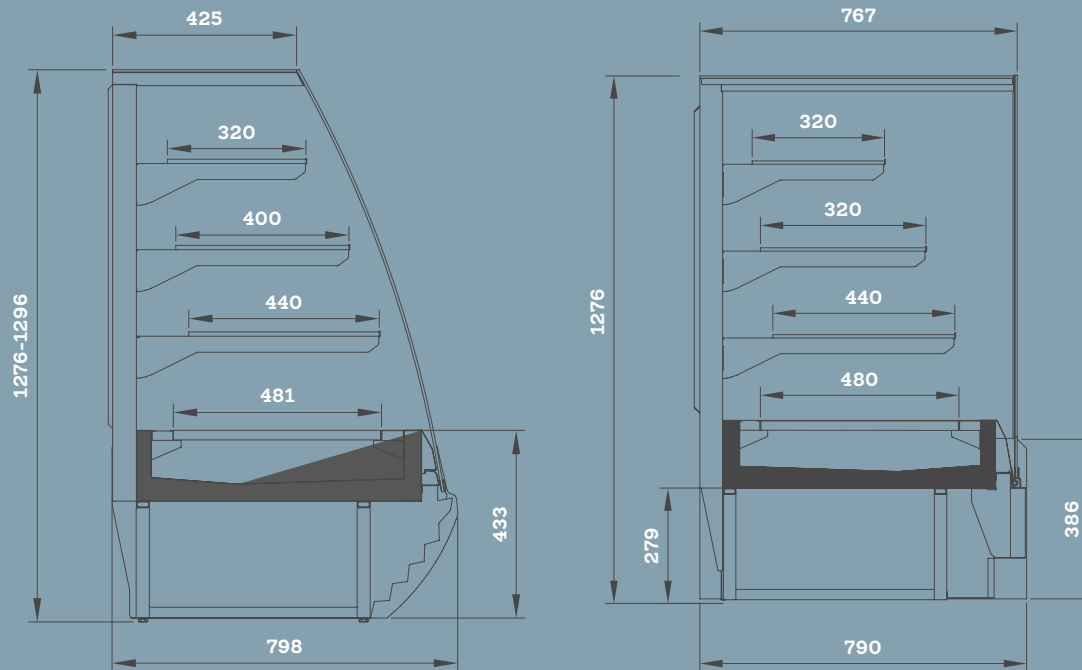

* Complete legend available on product sheets
found on our websites www.pastorfrigor.it

COMMERCIAL CATEGORIES*



TECHNICAL FEATURES*



Remote



Plug-in



Ventilated

AVAILABLE DIMENSIONS*

L: 625 - 937 - 1250

45°E

AVAILABLE VERSIONS*

Bread - Pane

REFRIGERANT*

Thermostatic expansion valve for
all the refrigerant in use
R290 built-in unit

Model not subject to Energy Labelling
(Ecodesign 2019/2024 and Energy Labelling 2019/2018).

Modello non soggetto ad etichettatura energetica
(Ecodesign 2019/2024 e Energy Labelling 2019/2018).



SERVEOVER COUNTERS



Kristina

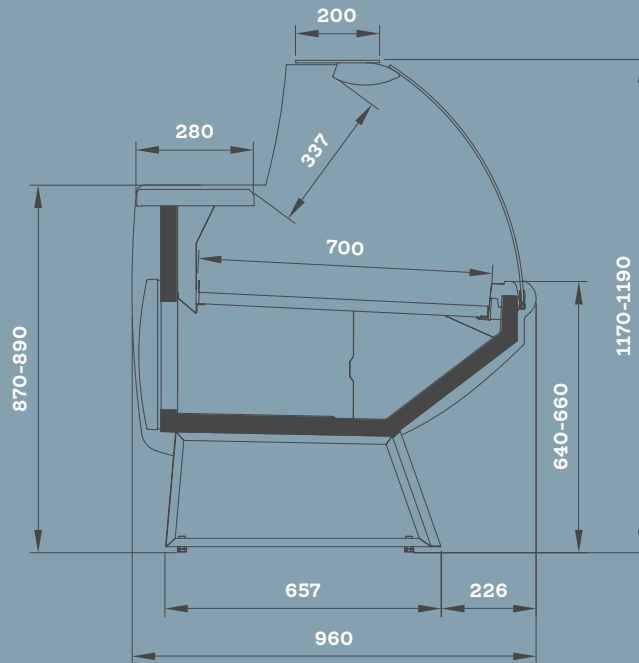

* Complete legend available on product sheets found on our websites www.pastorfrigor.it

COMMERCIAL CATEGORIES*



TECHNICAL FEATURES*



Plug-in



Low consumption fan

AVAILABLE DIMENSIONS*

L: 1250 - 1875

AVAILABLE VERSIONS*

Bread - Pane

REFRIGERANT*

Thermostatic expansion valve for all the refrigerant in use R290 built-in unit





Multidecks

MURALI



First company in Commercial Refrigeration to achieve **Energy Class A**.
I primi a raggiungere la **Classe Energetica A** nella refrigerazione commerciale.



MULTIDECKS



Genova Overview Doors



* Complete legend available on product sheets found on our websites www.pastorfrigor.it

COMMERCIAL CATEGORIES*



TECHNICAL FEATURES*



Plug-in



Low consumption fan



LED lighting



Propane refrigerant gas

AVAILABLE DIMENSIONS*

L: 937 - 1250 - 1875 - 2500 - 3750

D: 75 - 90

H: 205 - 216

AVAILABLE VERSIONS*

Waterloop

REFRIGERANT*

Thermostatic expansion valve for all the refrigerant in use
Co2 Refrigeration
R290 built in unit
Available with all the other refrigerant in use



Genova Overview Open

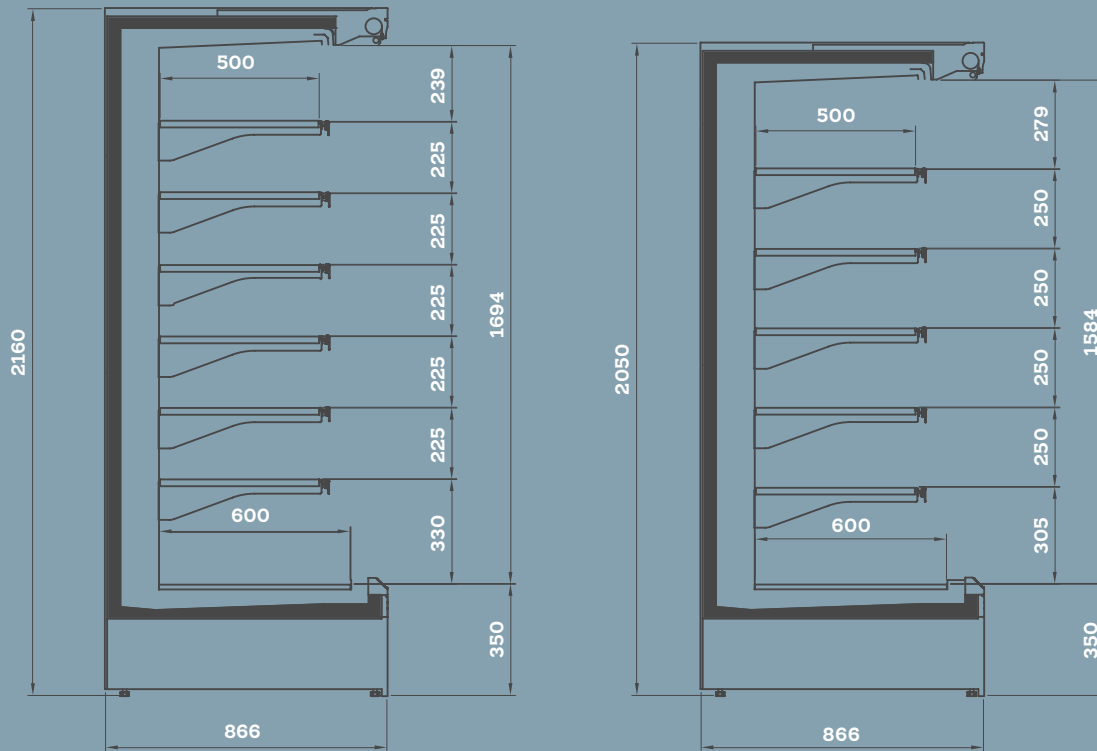

* Complete legend available on product sheets found on our websites www.pastorfrigor.it

COMMERCIAL CATEGORIES*



TECHNICAL FEATURES*



Plug-in



Low consumption fan



LED lighting



Propane refrigerant gas

AVAILABLE DIMENSIONS*

L: 937 - 1250 - 1875 - 2500

D: 75 - 90

H: 205 - 216

AVAILABLE VERSIONS*

Meat - Carne

Waterloop

REFRIGERANT*

Thermostatic expansion valve for all the refrigerant in use
Co2 Refrigeration
R290 built in unit
Available with all the other refrigerant in use

MULTIDECKS

Version: BT 780 Door Pitch



Version: BT 625 Door Pitch



Genova Overview BT

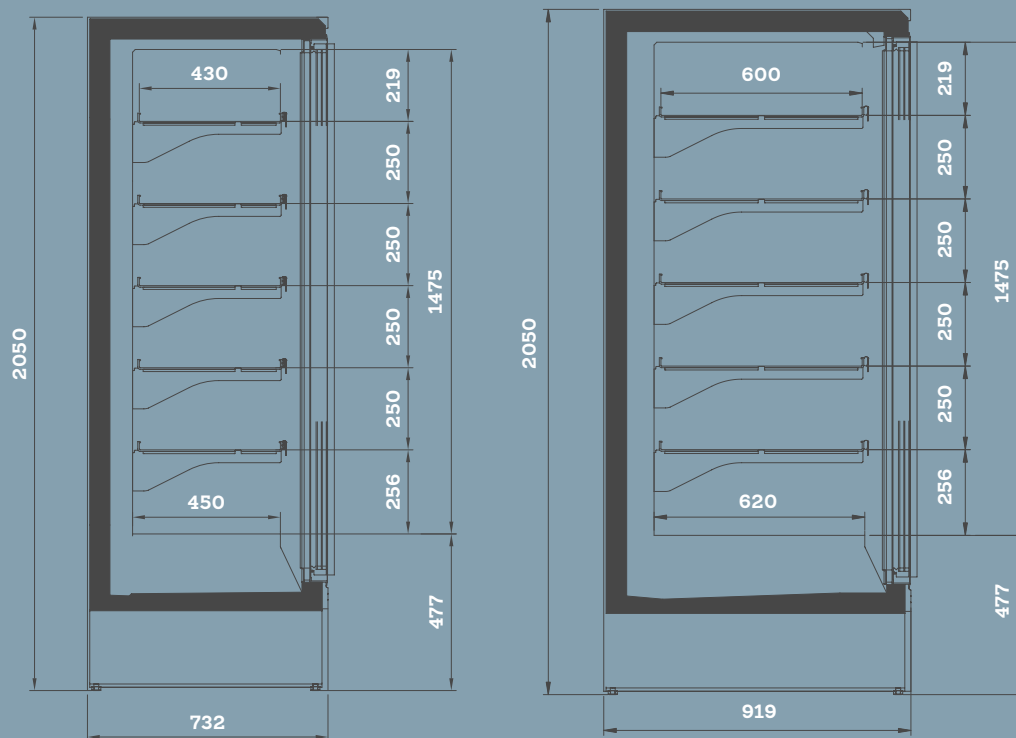

* Complete legend available on product sheets found on our websites www.pastorfrigor.it

COMMERCIAL CATEGORIES*



TECHNICAL FEATURES*



Plug-in



Low consumption fan



LED lighting



Propane refrigerant gas

AVAILABLE DIMENSIONS*

L: 625 - 780 - 1250 - 1560
1875 - 2340
D: 75 - 90
H: 205 - 216

AVAILABLE VERSIONS*

Waterloop

REFRIGERANT*

Thermostatic expansion valve for all the refrigerant in use
Co2 Refrigeration
R290 built in unit
Built in unit with all the other refrigerant in use

Version: H150 Doors



Version: H150 Open

MULTIDECKS



Genova Overview Doors

H1150

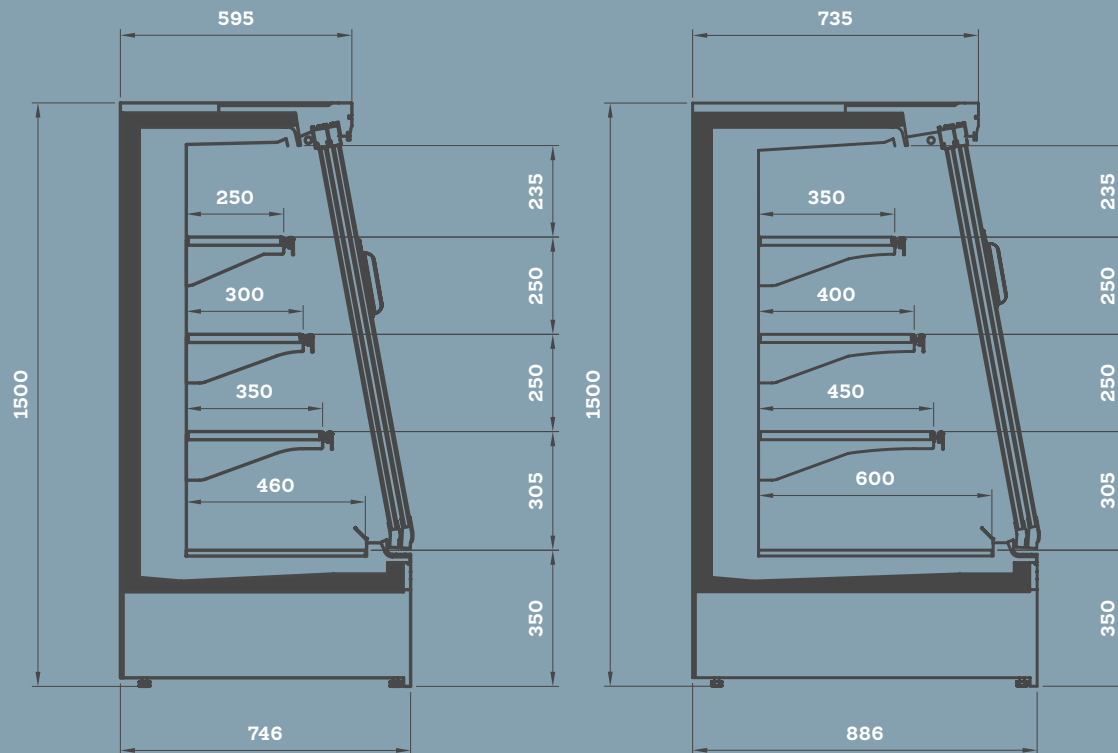

* Complete legend available on product sheets found on our websites www.pastorfrigor.it

COMMERCIAL CATEGORIES*



TECHNICAL FEATURES*



AVAILABLE DIMENSIONS*

L: 937 - 1250 - 1875 - 2500

D: 75

H: 165

AVAILABLE VERSIONS*

Meat - Carne

Waterloop

REFRIGERANT*

Thermostatic expansion valve

for all the refrigerant in use

Co2 Refrigeration

R290 built in unit

Available with all the other

refrigerant in use

Version: H165 Doors



Version: H165 Open



Genova Overview Doors H165



* Complete legend available on product sheets found on our websites www.pastorfrigor.it

COMMERCIAL CATEGORIES*



TECHNICAL FEATURES*



AVAILABLE DIMENSIONS*

L: 1250 - 1875 - 2500 - 3750
D: 75
H: 165

AVAILABLE VERSIONS*

Meat - Carne
Waterloop

REFRIGERANT*

Thermostatic expansion valve for all the refrigerant in use
Co2 Refrigeration
R290 built in unit
Available with all the other refrigerant in use



Lem H150

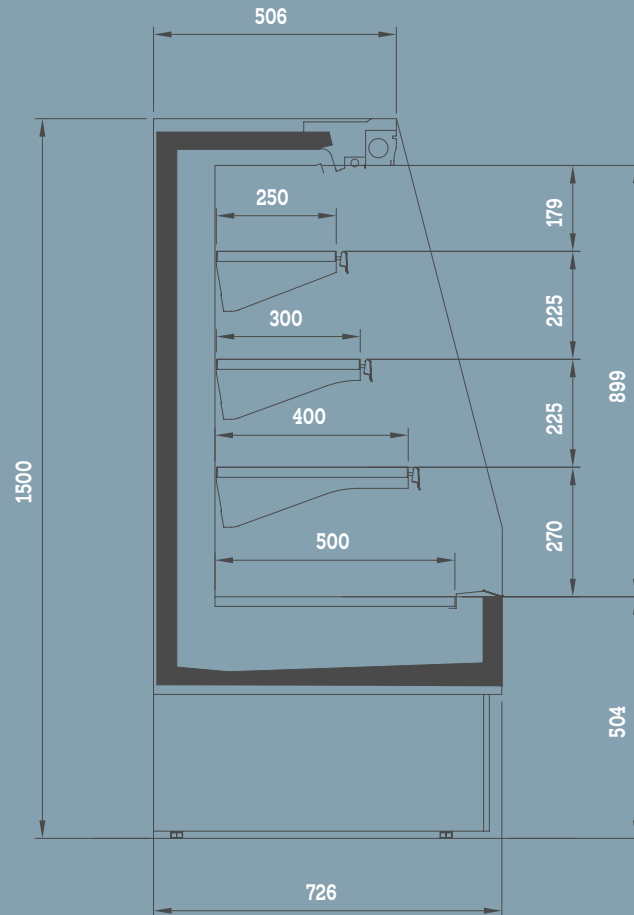

* Complete legend available on product sheets found on our websites www.pastorfrigor.it

COMMERCIAL CATEGORIES*



TECHNICAL FEATURES*



AVAILABLE DIMENSIONS*

L: 625 - 937 - 1250
1875 - 2500
H: 150
D: 73

AVAILABLE VERSIONS*

Meat - Carne

REFRIGERANT*

Thermostatic expansion valve for all the refrigerant in use
Co2 Refrigeration
R290 built in unit
Available with all the other refrigerant in use



Lem

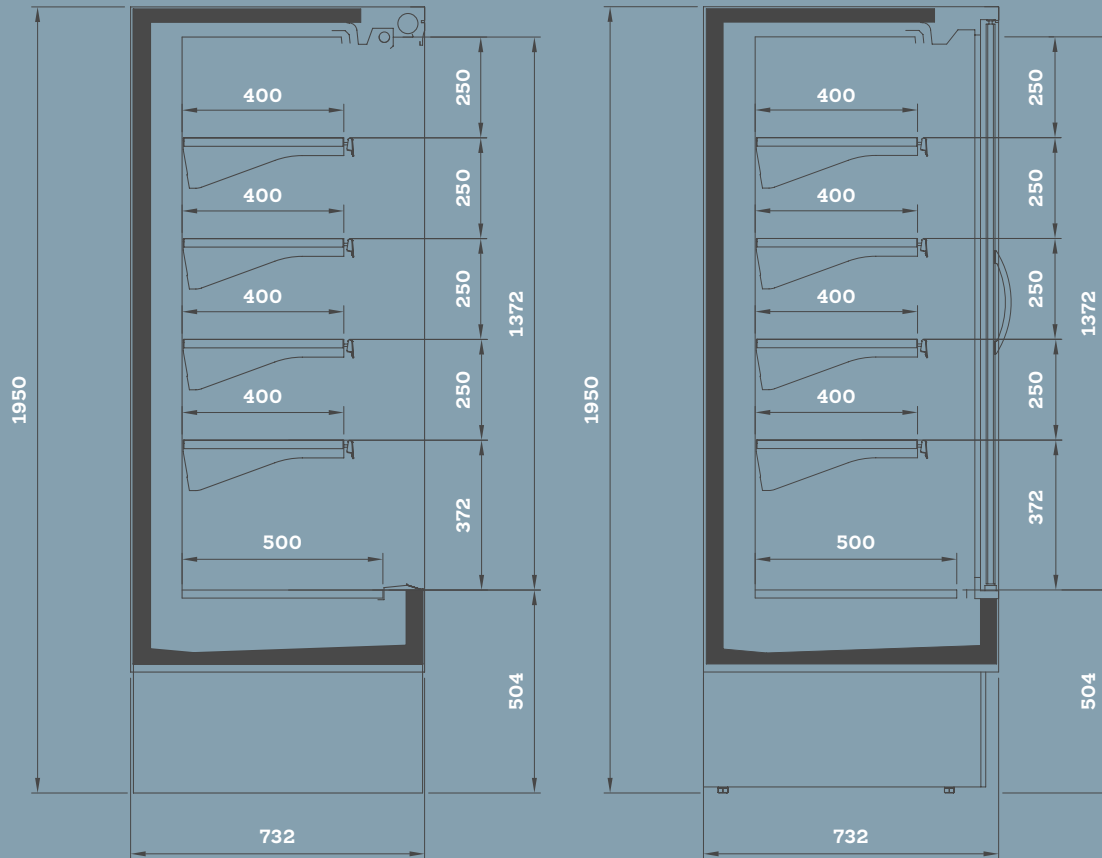

* Complete legend available on product sheets
found on our websites www.pastorfrigor.it

COMMERCIAL CATEGORIES*



TECHNICAL FEATURES*



Plug-in



Low
consumption fan



LED
lighting



R290
Propane
refrigerant gas

AVAILABLE DIMENSIONS*

L: 625 - 937 - 1250
1875 - 2500
H: 195
D: 73

AVAILABLE VERSIONS*

Meat - Carne
Doors - Porte

REFRIGERANT*

Thermostatic expansion valve
for all the refrigerant in use
Co2 Refrigeration
R290 built in unit
Available with all the other
refrigerant in use



Pangea

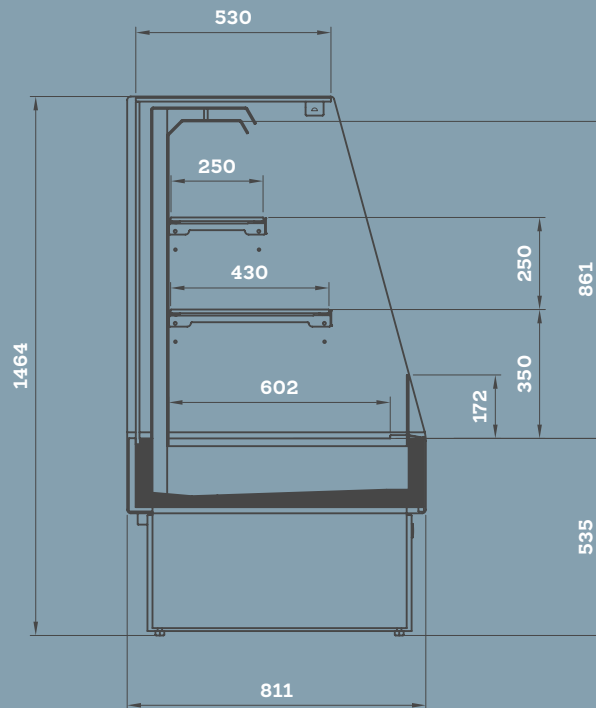

* Complete legend available on product sheets
found on our websites www.pastorfrigor.it

COMMERCIAL CATEGORIES*

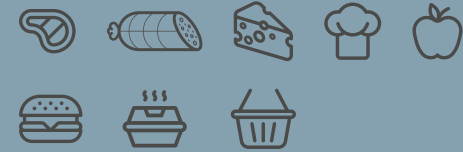

TECHNICAL FEATURES*



Plug-in



Low
consumption
fan



Propane
refrigerant
gas

AVAILABLE DIMENSIONS*

L: 937 - 1250

REFRIGERANT*

Thermostatic expansion valve for
all the refrigerant in use
Co2 Refrigeration
R290 built in unit
Built in unit with all the other refri-
gerant in use



Venezia Overview Open

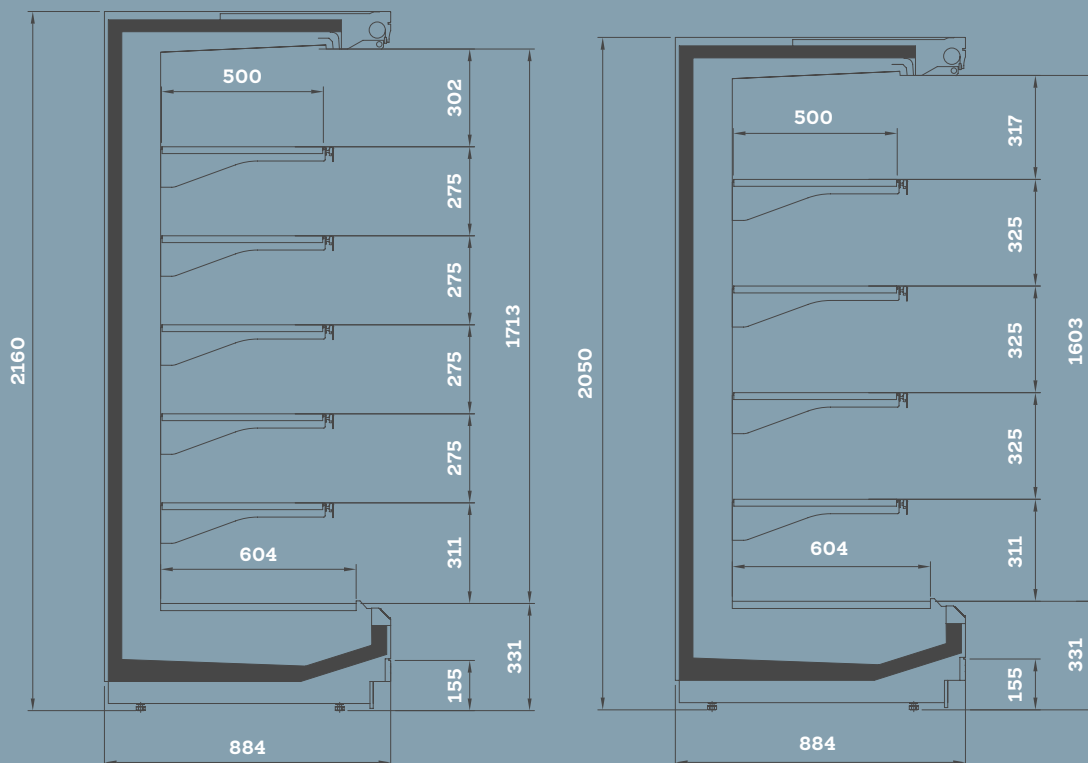

* Complete legend available on product sheets found on our websites www.pastorfrigor.it

COMMERCIAL CATEGORIES*



TECHNICAL FEATURES*



Remote



Ventilated

AVAILABLE DIMENSIONS*

L: 1250 - 1875 - 2500 - 3750

D: 75 - 90 - 100 - 110

H: 205 - 216

AVAILABLE VERSIONS*

Meat - Carne

F&VEG - Ortofrutta

REFRIGERANT*

Thermostatic expansion valve for all the refrigerant in use
Co2 Refrigeration

MULTIDECKS

B
A ↑
G



Venezia Overview Doors

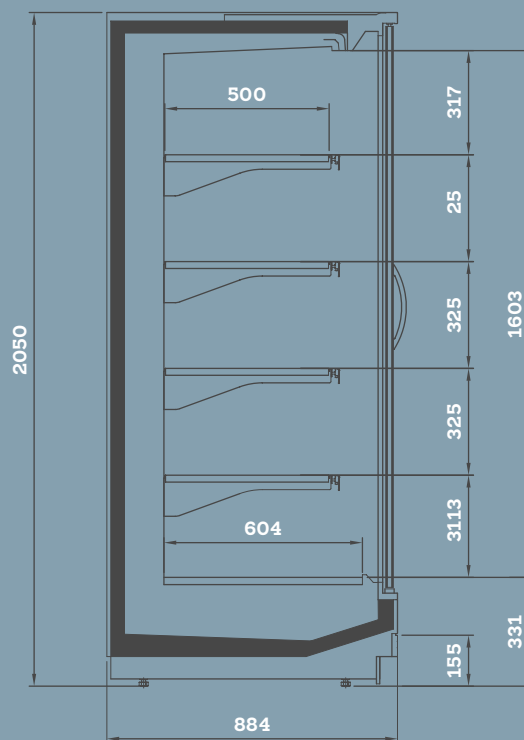
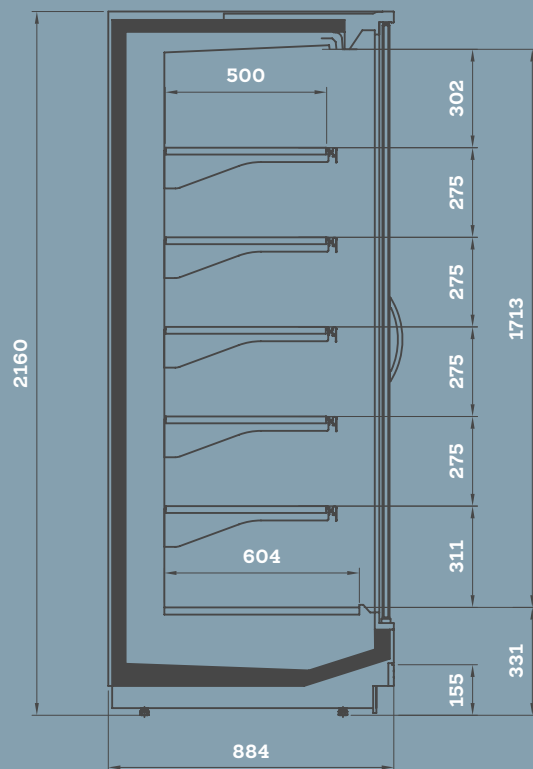

* Complete legend available on product sheets
found on our websites www.pastorfrigor.it

COMMERCIAL CATEGORIES*



TECHNICAL FEATURES*



Remote



Ventilated

AVAILABLE DIMENSIONS*

L: 1250 - 1875 - 2500 - 3750

D: 75 - 90 - 100 - 110

H: 205 - 216

REFRIGERANT*

Thermostatic expansion valve
for all the refrigerant in use
Co2 Refrigeration

Version: H 160



Version: H 130



MULTIDECKS



Venezia Overview Basso

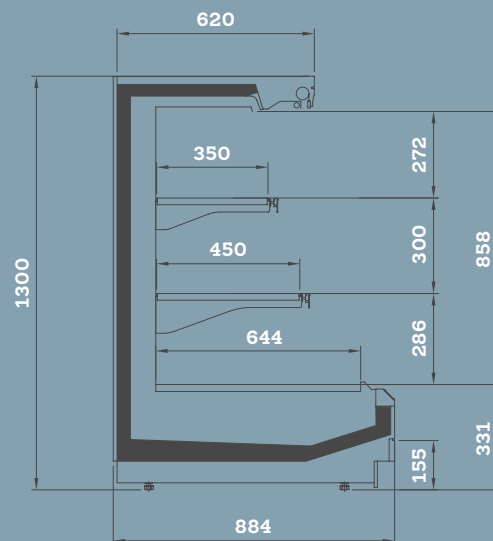
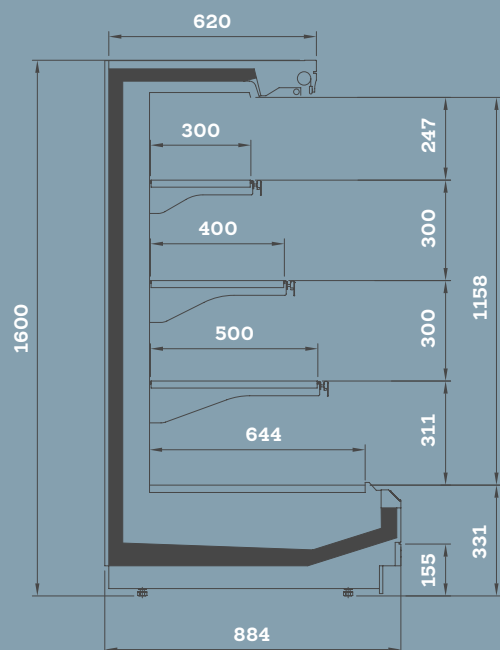

* Complete legend available on product sheets
found on our websites www.pastorfrigor.it

COMMERCIAL CATEGORIES*



TECHNICAL FEATURES*



Remote



Ventilated

AVAILABLE DIMENSIONS*

L: 1250 - 1875 - 2500 - 3750

D: 90 - 100

H: 130 - 160

REFRIGERANT*

Thermostatic expansion valve
for all the refrigerant in use
Co2 Refrigeration

Version: H 160

MULTIDECKS



Venezia Overview Basso Doors

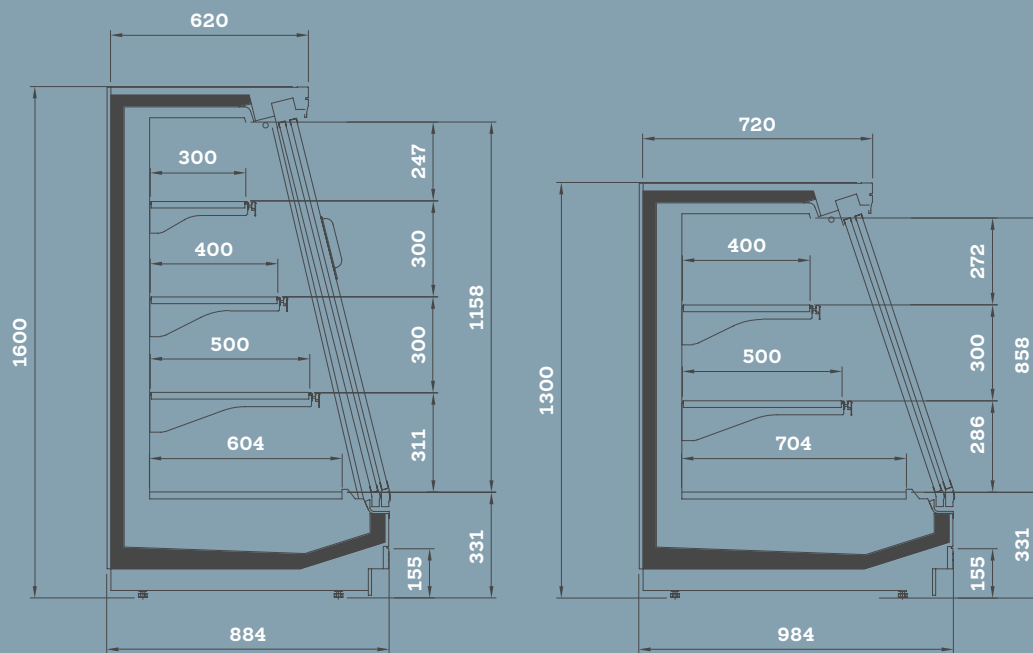

* Complete legend available on product sheets found on our websites www.pastorfrigor.it

COMMERCIAL CATEGORIES*



TECHNICAL FEATURES*



Remote



Ventilated

AVAILABLE DIMENSIONS*

L: 1250 - 1875 - 2500 - 3750

D: 90 - 100

H: 130 - 160

REFRIGERANT*

Thermostatic expansion valve
for all the refrigerant in use
Co2 Refrigeration



MULTIDECKS



Venezia Overview Open H1150

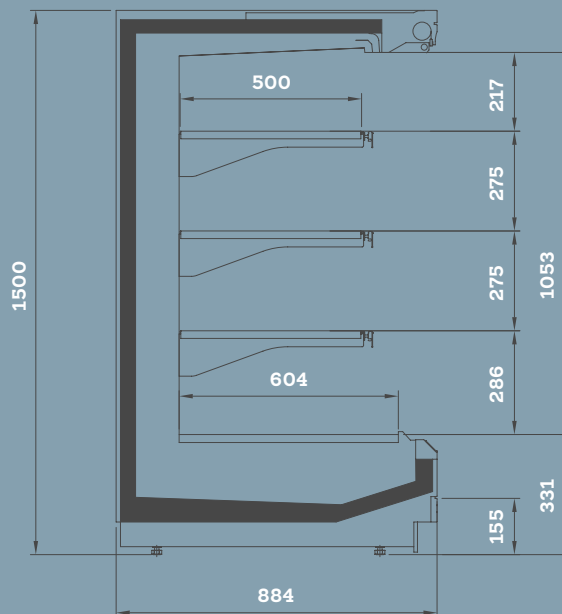

* Complete legend available on product sheets
found on our websites www.pastorfrigor.it

COMMERCIAL CATEGORIES*



TECHNICAL FEATURES*



Remote



Ventilated

AVAILABLE DIMENSIONS*

L: 1250 - 1875 - 2500 - 3750

D: 90

H: 150

AVAILABLE VERSIONS*

Meat - Carne

REFRIGERANT*

Thermostatic expansion valve
for all the refrigerant in use
Co2 Refrigeration

MULTIDECKS

B
A ↑
G



Venezia Overview Doors

H1150

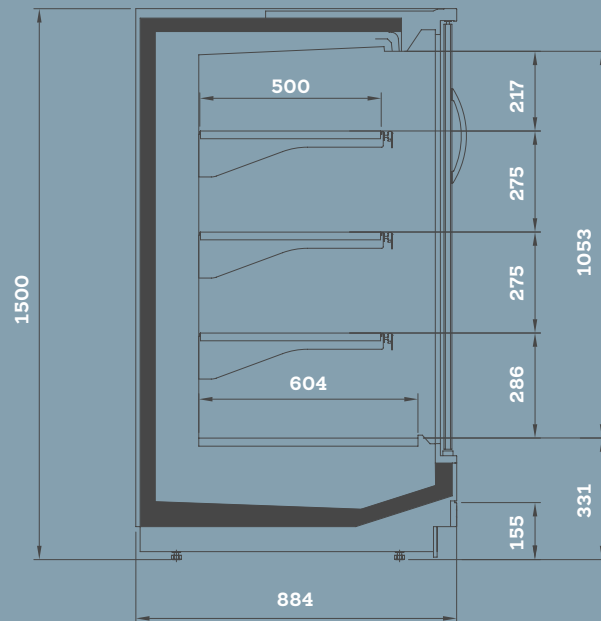

* Complete legend available on product sheets
found on our websites www.pastorfrigor.it

COMMERCIAL CATEGORIES*

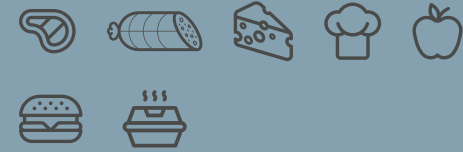

TECHNICAL FEATURES*



Remote



Ventilated

AVAILABLE DIMENSIONS*

L: 1250 - 1875 - 2500 - 3750

D: 90

H: 150

REFRIGERANT*

Thermostatic expansion valve for
all the refrigerant in use
Co2 Refrigeration



Venezia Overview Roll In

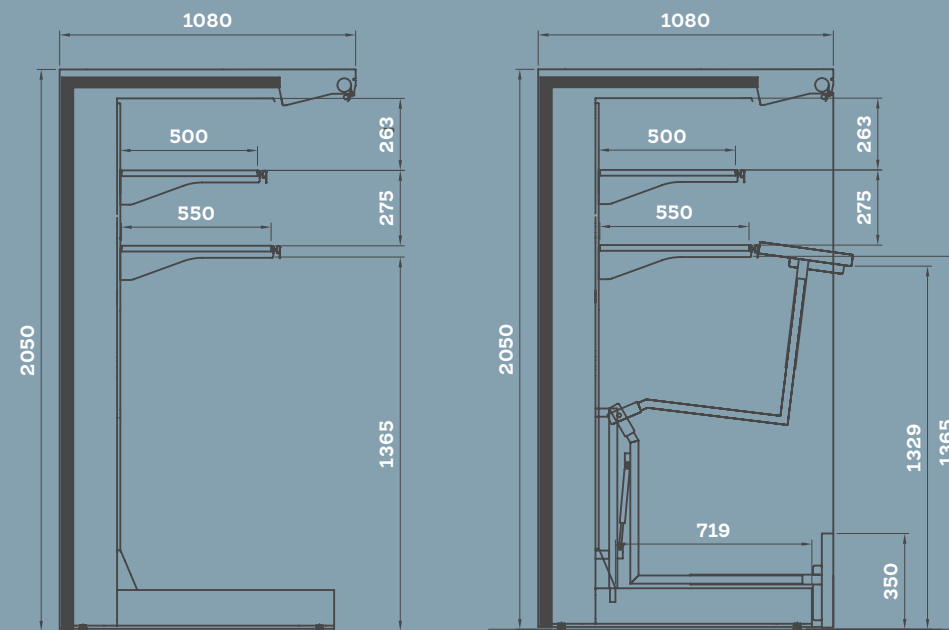

* Complete legend available on product sheets found on our websites www.pastorfrigor.it

COMMERCIAL CATEGORIES*



TECHNICAL FEATURES*



Remote



Ventilated

AVAILABLE DIMENSIONS*

L: 1375 - 1875 - 2500 - 2750 - 3750

D: 110 - 120

H: 205 - 216

AVAILABLE VERSIONS*

With liftable front

Frontale ribaltabile

Without front

Senza frontale

REFRIGERANT*

Thermostatic expansion valve for all the refrigerant in use
Co2 Refrigeration



Venezia Sushi

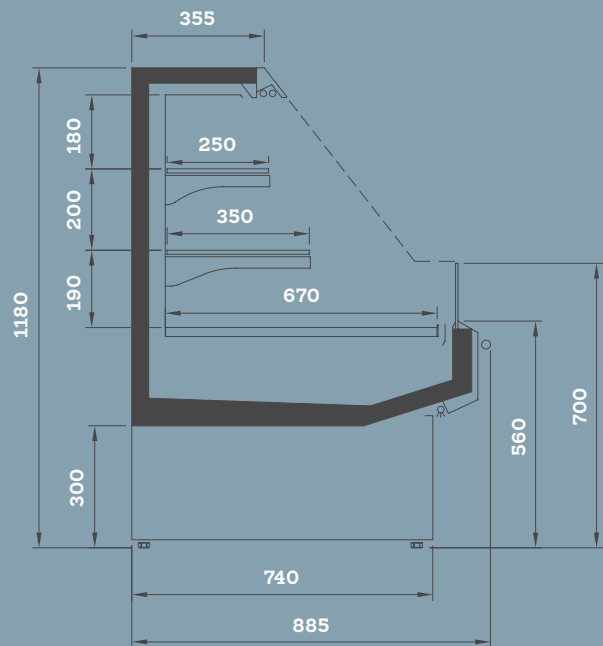

* Complete legend available on product sheets found on our websites www.pastorfrigor.it

COMMERCIAL CATEGORIES*



TECHNICAL FEATURES*



AVAILABLE DIMENSIONS*

L: 1250 - 1875 - 2500 - 3125

D: 90

H: 118

AVAILABLE VERSIONS*

Meat - Carne

REFRIGERANT*

Co2 Refrigeration

R455 built-in unit



Verona Overview Open

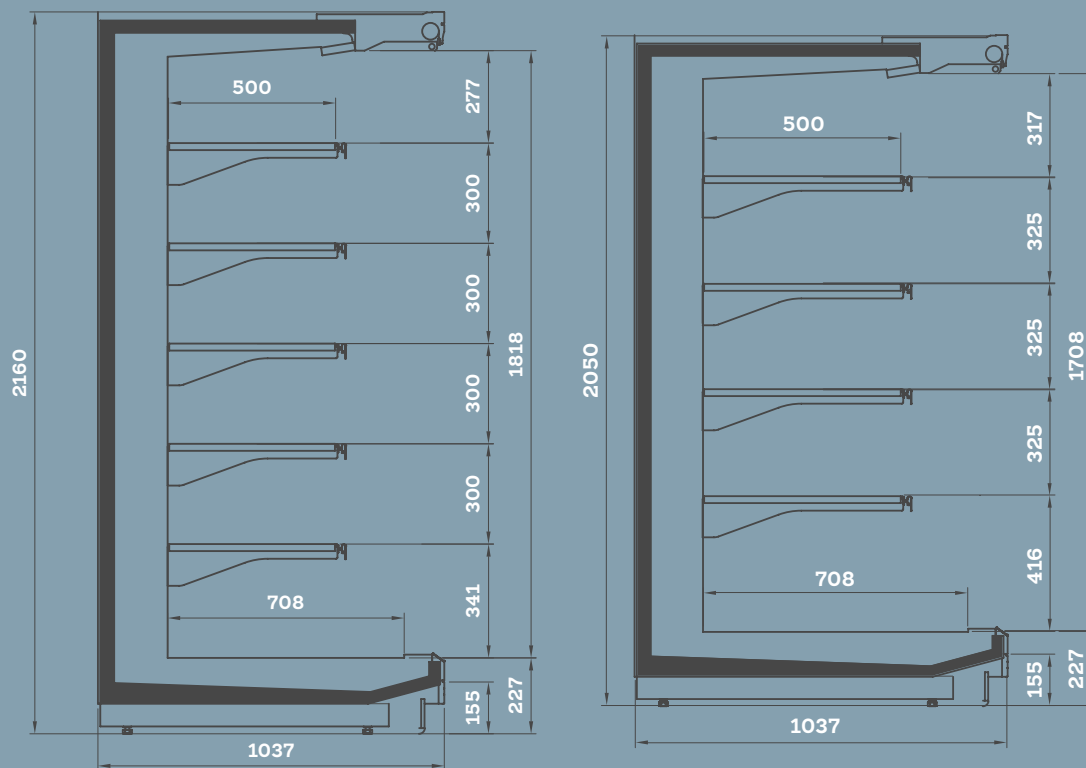

* Complete legend available on product sheets found on our websites www.pastorfrigor.it

COMMERCIAL CATEGORIES*



TECHNICAL FEATURES*



Remote



Ventilated

AVAILABLE DIMENSIONS*

L: 1250 - 1875 - 2500 - 3750

D: 105 - 115

H: 205 - 216

AVAILABLE VERSIONS*

Meat - Carne

F&VEG - Ortofrutta

REFRIGERANT*

Thermostatic expansion valve for all the refrigerant in use
Co2 Refrigeration

MULTIDECKS



Verona Overview Doors

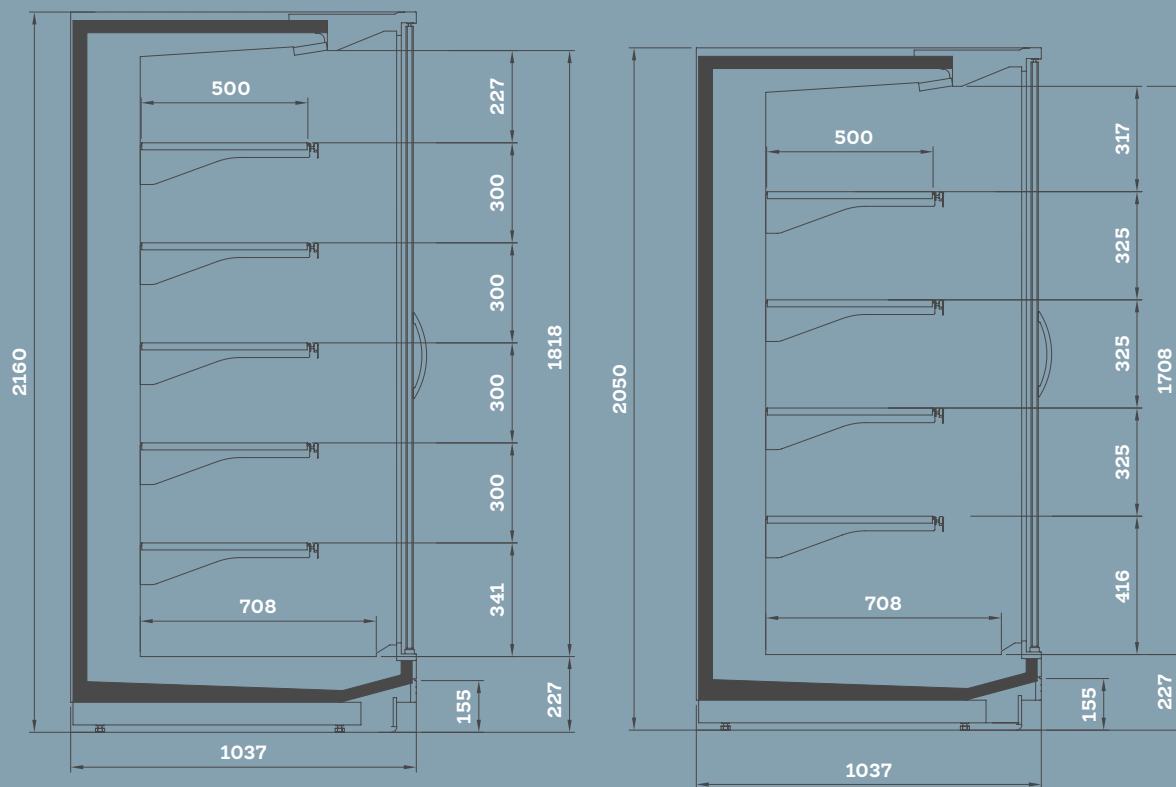

* Complete legend available on product sheets found on our websites www.pastorfrigor.it

COMMERCIAL CATEGORIES*

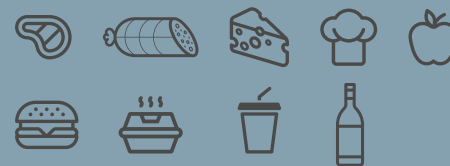

TECHNICAL FEATURES*



Remote



Ventilated

AVAILABLE DIMENSIONS*

L: 1250 - 1875 - 2500 - 3750

D: 105 - 115

H: 205 - 216

REFRIGERANT*

Thermostatic expansion valve for all the refrigerant in use
Co2 Refrigeration



Roma

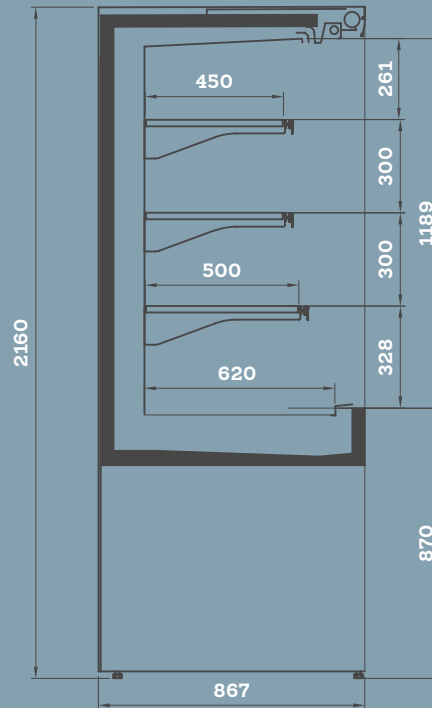
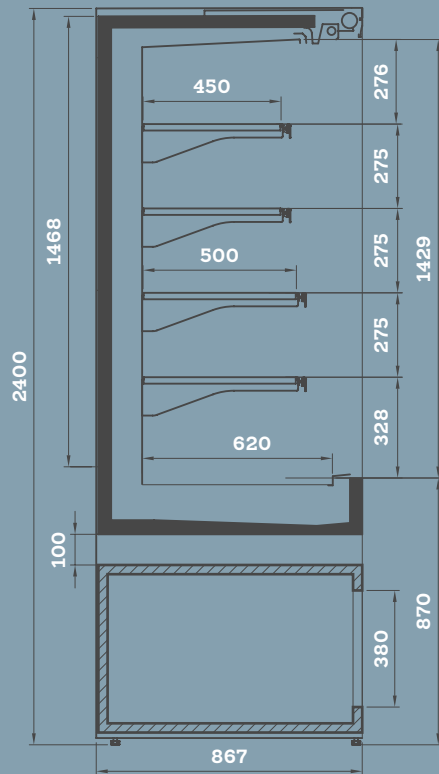

* Complete legend available on product sheets
found on our websites www.pastorfrigor.it

COMMERCIAL CATEGORIES*



TECHNICAL FEATURES*



Remote



Plug-in



Ventilated

AVAILABLE DIMENSIONS*

L: 1250 - 1875 - 2500

D: 85

H: 216 - 240

REFRIGERANT*

Thermostatic expansion valve
for all the refrigerant in use
Co2 Refrigeration
R290 built in unit
Available with all the other
refrigerant in use



MULTIDECKS



Up

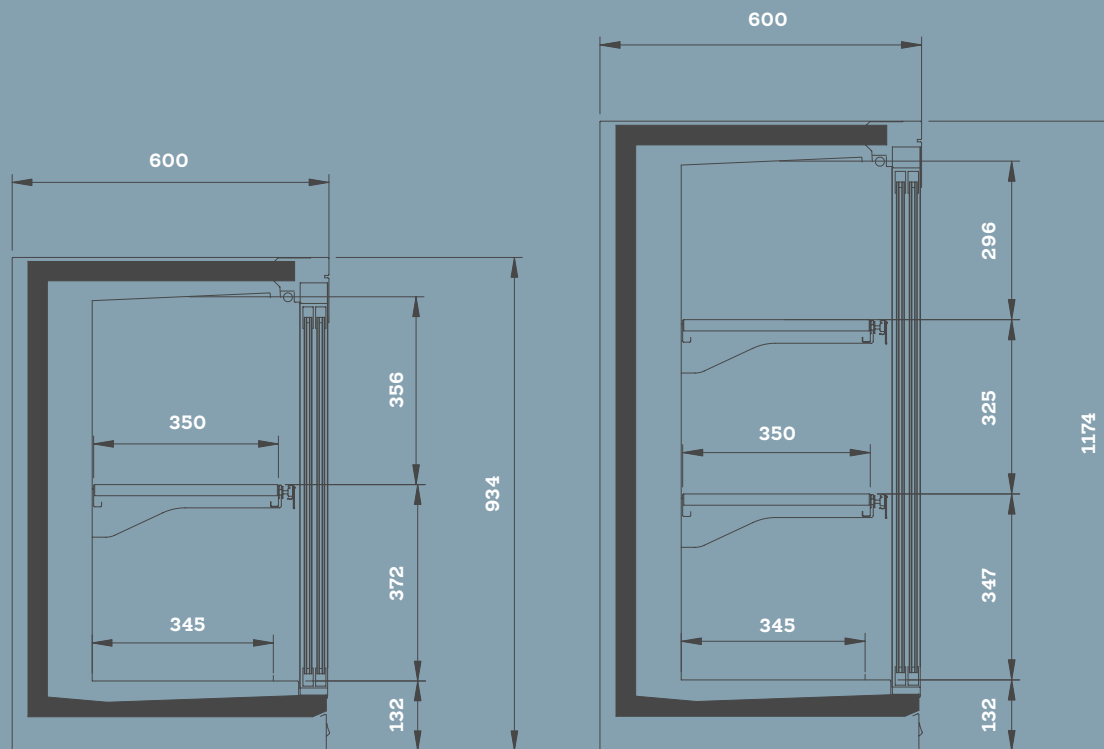

* Complete legend available on product sheets
found on our websites www.pastorfrigor.it

COMMERCIAL CATEGORIES*



TECHNICAL FEATURES*



Remote



Ventilated

AVAILABLE DIMENSIONS*

L: 1250

D: 60

H: 94 - 118

REFRIGERANT*

Thermostatic expansion valve
for all the refrigerant in use
Co2 Refrigeration



MULTIDECKS



Milano Overview

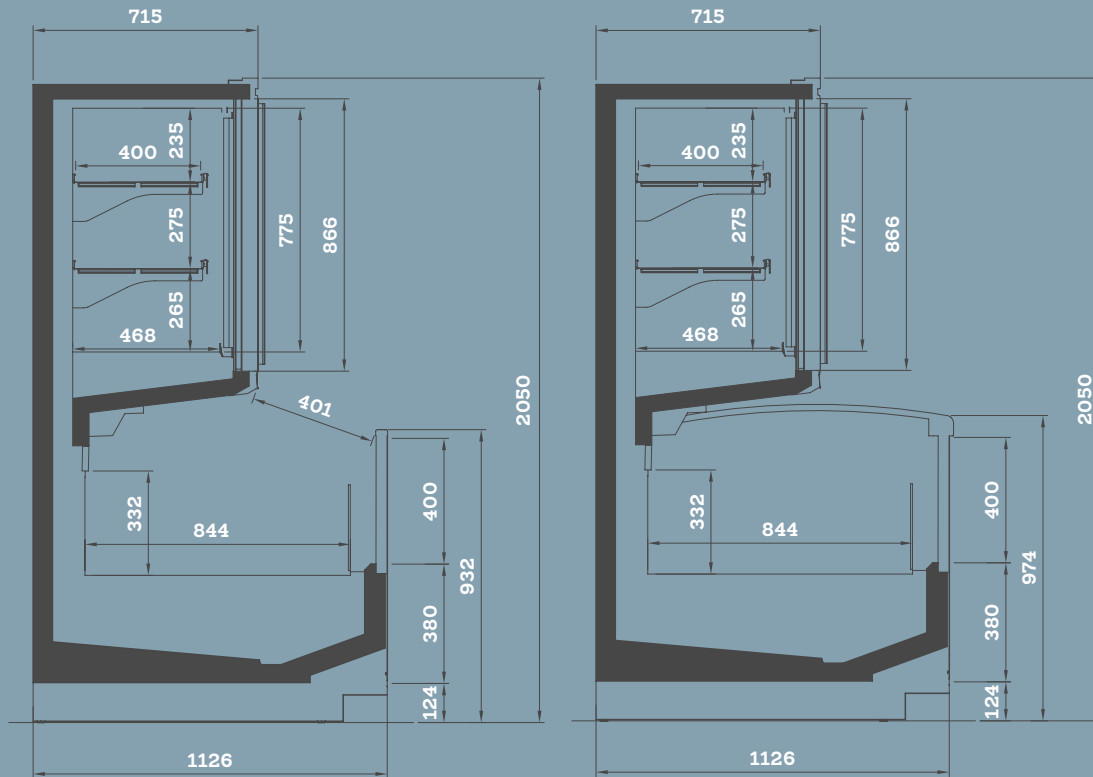

* Complete legend available on product sheets found on our websites www.pastorfrigor.it

COMMERCIAL CATEGORIES*



TECHNICAL FEATURES*



Remote



Ventilated

AVAILABLE DIMENSIONS*

L: 1875 - 2500 - 3750

D: 112

H: 205 - 216

AVAILABLE VERSIONS*

HG - Front high glass

REFRIGERANT*

Thermostatic expansion valve for all the refrigerant in use
Co2 Refrigeration

MULTIDECKS

D
A ↑
G



Torino Overview

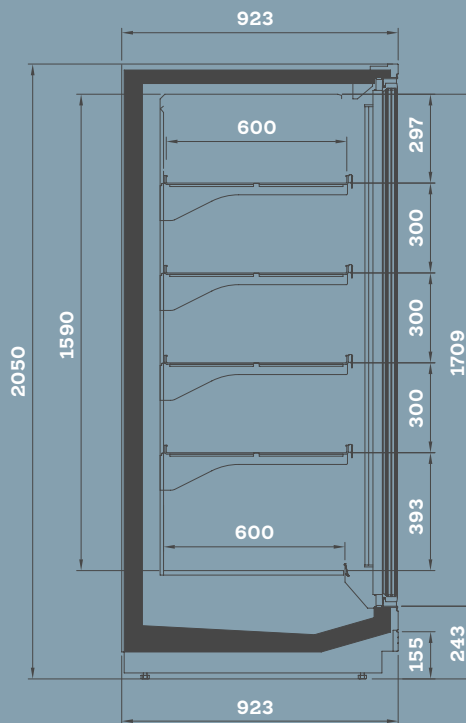
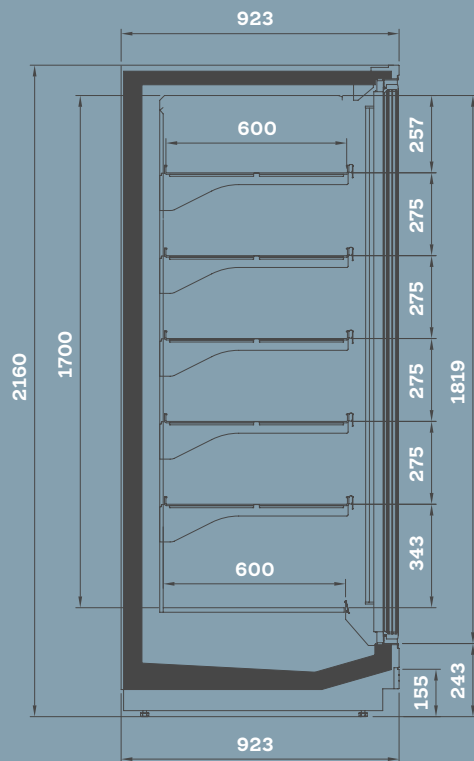

* Complete legend available on product sheets
found on our websites www.pastorfrigor.it

COMMERCIAL CATEGORIES*



TECHNICAL FEATURES*



Remote



Ventilated

AVAILABLE DIMENSIONS*

L: 785 - 1560 - 2341 - 3120 - 3899

D: 90

H: 205 - 216

REFRIGERANT*

Thermostatic expansion valve
for all the refrigerant in use
Co2 Refrigeration



MULTIDECKS



Torino Overview H150

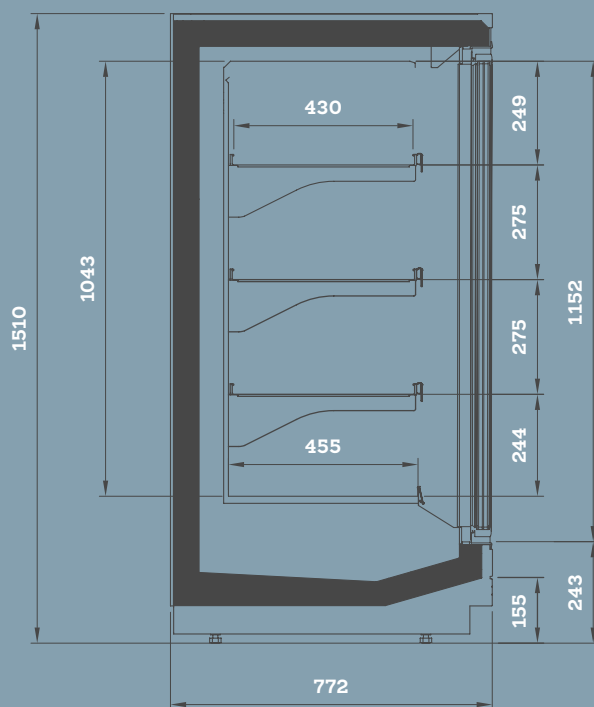

* Complete legend available on product sheets found on our websites www.pastorfrigor.it

COMMERCIAL CATEGORIES*



TECHNICAL FEATURES*



Remote



Ventilated

AVAILABLE DIMENSIONS*

L: 785 - 1560 - 2341 - 3120 - 3899

D: 75

H: 150

REFRIGERANT*

Thermostatic expansion valve for all the refrigerant in use
Co2 Refrigeration



Sofia

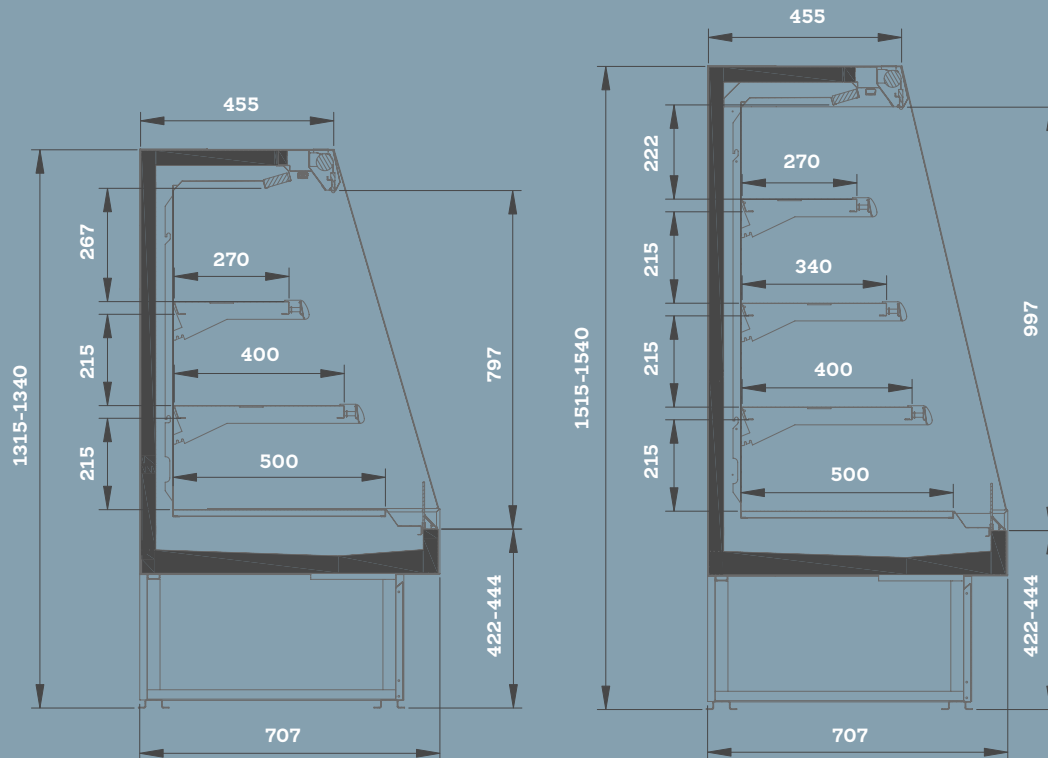

* Complete legend available on product sheets found on our websites www.pastorfrigor.it

COMMERCIAL CATEGORIES*



TECHNICAL FEATURES*



Plug-in



Ventilated



LED lighting



Propane refrigerant gas

AVAILABLE DIMENSIONS*

L: 625 - 937 - 1250 - 1875

H: 130 - 150

AVAILABLE VERSIONS*

Meat - Carne

REFRIGERANT*

R290 built in unit

Sara



Sara Q



Sara

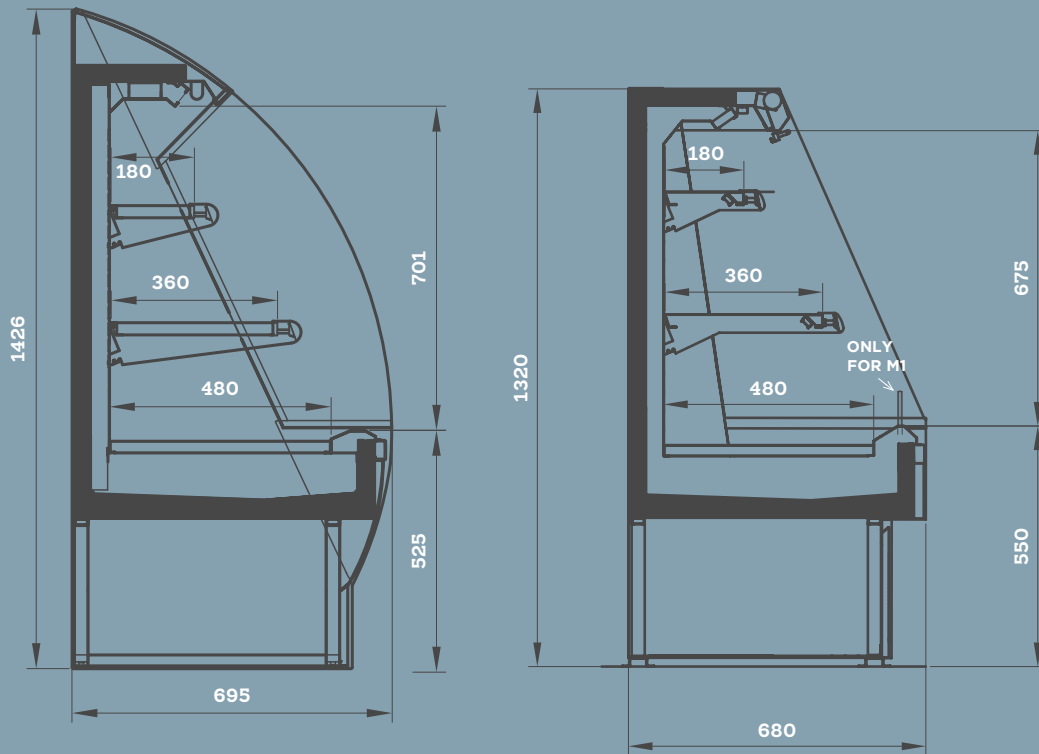

* Complete legend available on product sheets found on our websites www.pastorfrigor.it

COMMERCIAL CATEGORIES*



TECHNICAL FEATURES*



Plug-in



Ventilated

AVAILABLE DIMENSIONS*

L: 625 - 937 - 1250 - 1875

H: 130 - 140 - 150 - 160

REFRIGERANT*

Thermostatic expansion valve for all the refrigerant in use

Kalifornia Q



Kalifornia D



Kalifornia Q

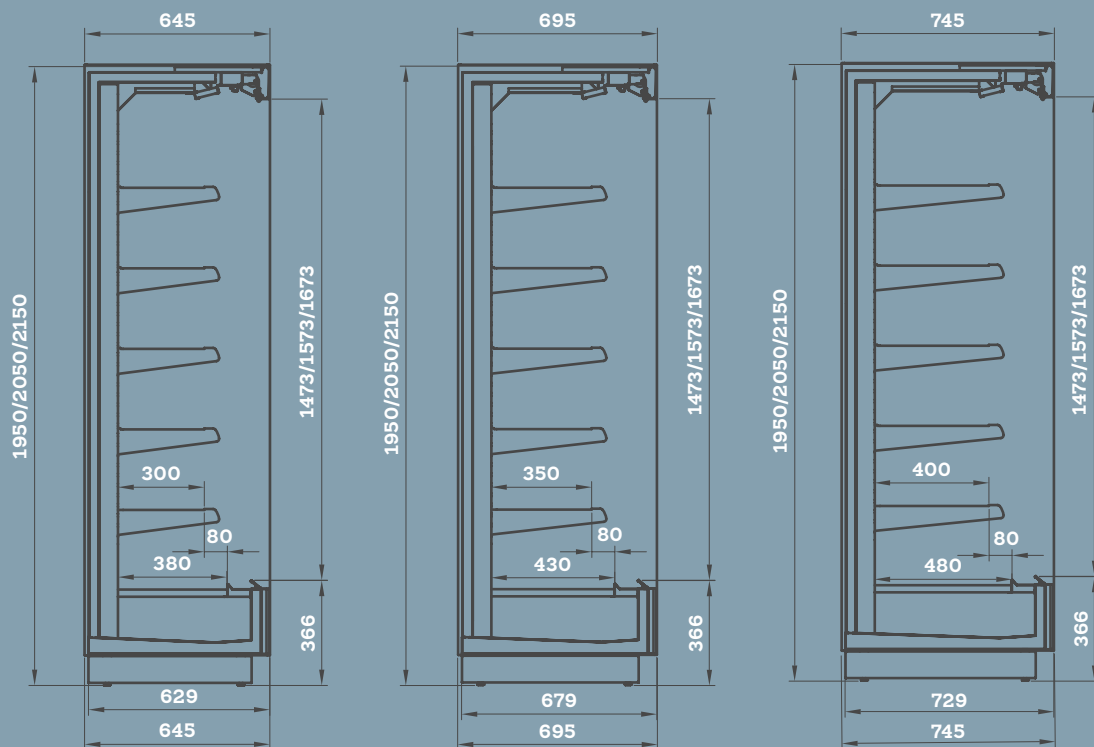

* Complete legend available on product sheets found on our websites www.pastorfrigor.it

COMMERCIAL CATEGORIES*



TECHNICAL FEATURES*



Remote



Ventilated

AVAILABLE DIMENSIONS*

L: 1250 - 1875 - 2500 - 3750

D: 60 - 70 - 75 - 80

H: 195 - 205 - 216

AVAILABLE VERSIONS*

Meat - Carne

F&VEG - Ortofrutta

With doors - Con porte

REFRIGERANT*

Thermostatic expansion valve for all the refrigerant in use
Co2 Refrigeration



Islands

ISOLE

ISLANDS



Vulcano

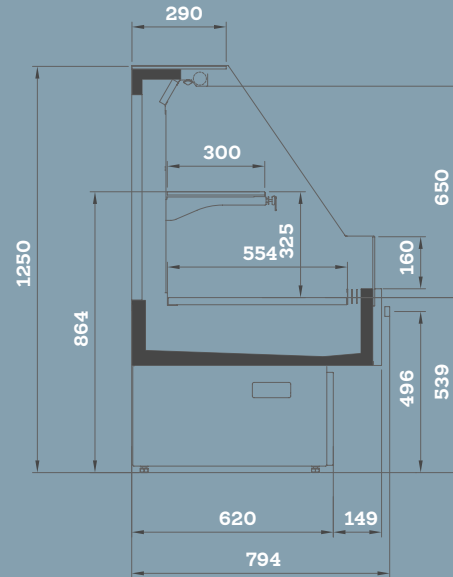
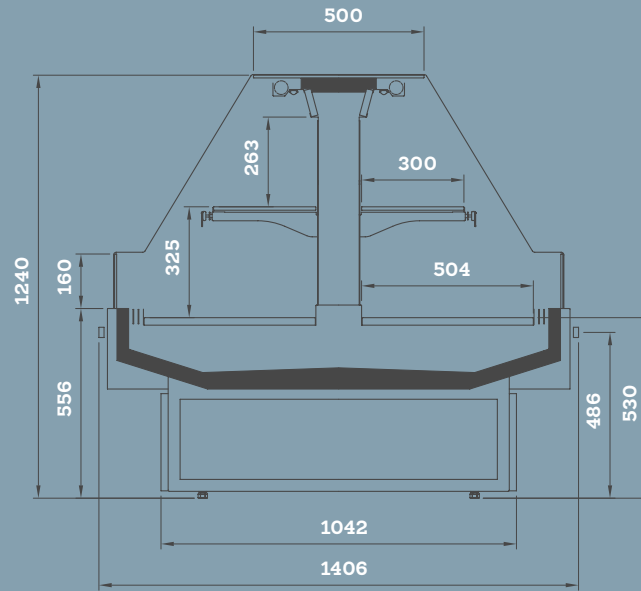

* Complete legend available on product sheets found on our websites www.pastorfrigor.it

COMMERCIAL CATEGORIES*



TECHNICAL FEATURES*



AVAILABLE DIMENSIONS*

L: 1250 - 1875

Headcases - Testate

REFRIGERANT*

Co2 Refrigeration
Remote with valve
R290 built-in unit



Maii

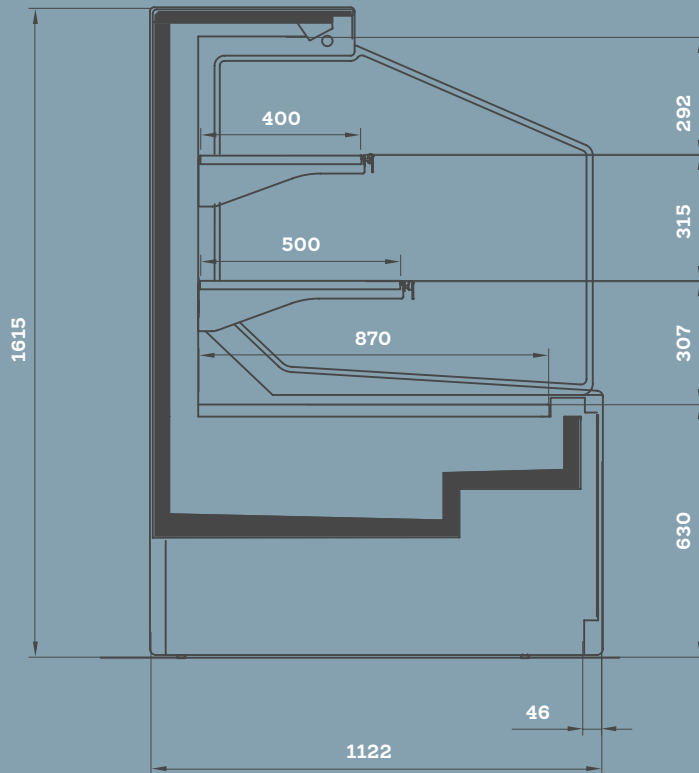

* Complete legend available on product sheets found on our websites www.pastorfrigor.it

COMMERCIAL CATEGORIES*

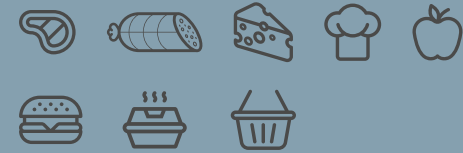

TECHNICAL FEATURES*



Remote



Ventilated

AVAILABLE DIMENSIONS*

L: 1250 - 1875 - 2500 - 3750

Headcases - Testate

REFRIGERANT*

Thermostatic expansion valve
for all the refrigerant in use
Co2 Refrigeration



Panarea HD

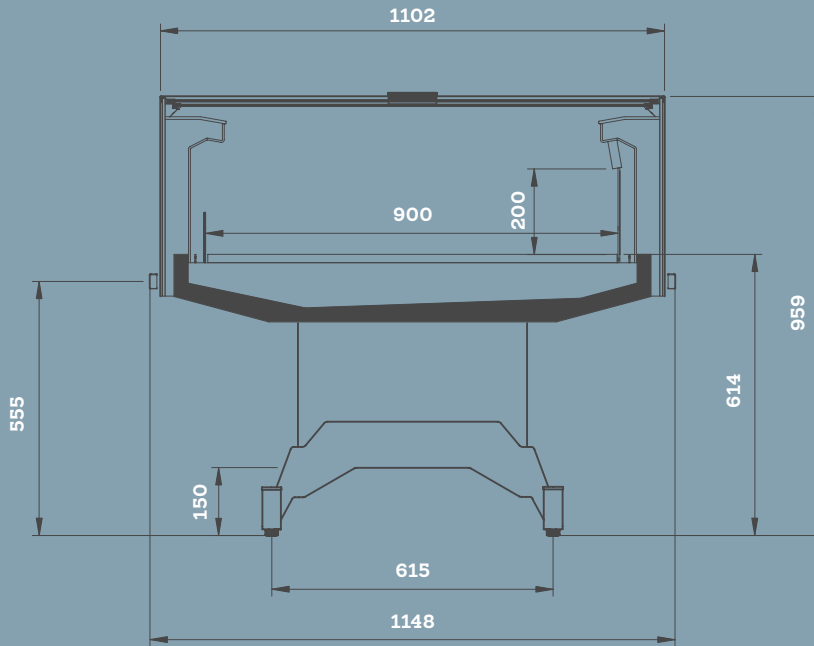

* Complete legend available on product sheets found on our websites www.pastorfrigor.it

COMMERCIAL CATEGORIES*

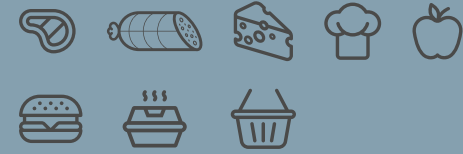

TECHNICAL FEATURES*



Plug-in



Low
consumption
fan



R290
Propane
refrigerant
gas

AVAILABLE DIMENSIONS*

L: 937 - 1250

AVAILABLE VERSIONS*

Open Version - Aperto

REFRIGERANT*

Thermostatic expansion valve for all the refrigerant in use
Co2 Refrigeration
R290 built in unit
Built in unit with all the other refrigerant in use



Panarea HD BMM

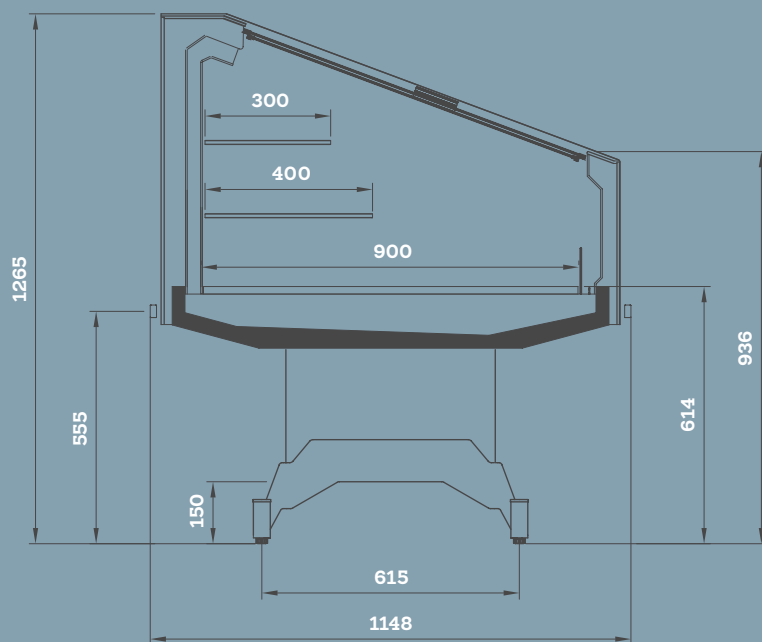

* Complete legend available on product sheets found on our websites www.pastorfrigor.it

COMMERCIAL CATEGORIES*



TECHNICAL FEATURES*



Plug-in



Low
consumption
fan



R290
Propane
refrigerant
gas

AVAILABLE DIMENSIONS*

L: 937 - 1250

REFRIGERANT*

Thermostatic expansion valve for all the refrigerant in use
Co2 Refrigeration
R290 built in unit
Built in unit with all the other refrigerant in use

AVAILABLE VERSIONS*

With sliding doors - Con chiusure scorrevoli

ISLANDS



Islanda

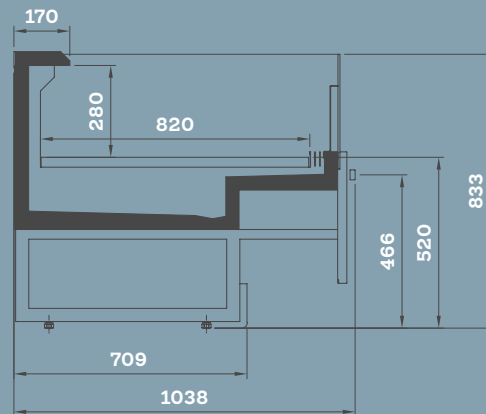
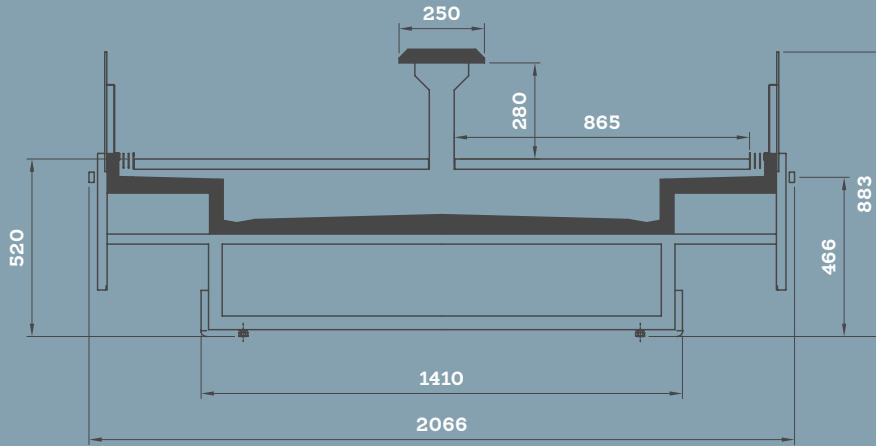

* Complete legend available on product sheets found on our websites www.pastorfrigor.it

COMMERCIAL CATEGORIES*

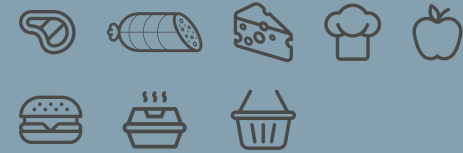

TECHNICAL FEATURES*



Remote



Low consumption fan



Electric defrost

AVAILABLE DIMENSIONS*

L: 1875 - 2500 - 3750

Headcases - Testate

REFRIGERANT*

Thermostatic expansion valve for all the refrigerant in use
Co2 Refrigeration

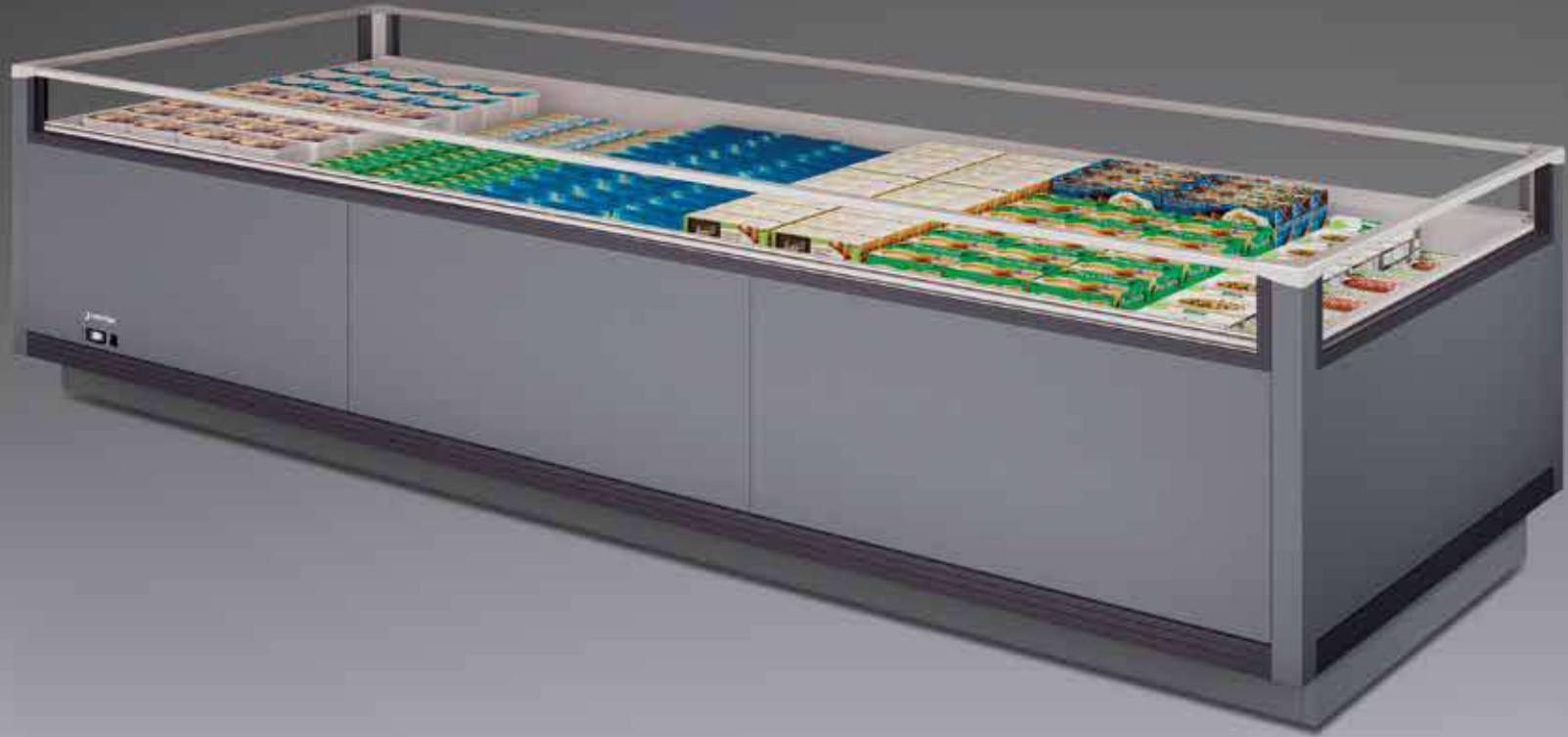

ISLANDS



Sicilia Overview

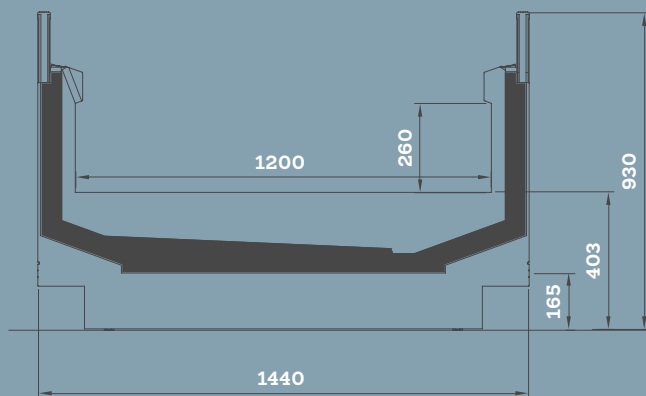

* Complete legend available on product sheets found on our websites www.pastorfrigor.it

COMMERCIAL CATEGORIES*



TECHNICAL FEATURES*



Remote



Ventilated

AVAILABLE DIMENSIONS*

L: 1875 - 2500 - 3750

D: 150

REFRIGERANT*

Thermostatic expansion valve for all the refrigerant in use
Co2 Refrigeration

AVAILABLE VERSIONS*

With sliding doors - Con chiusure scorrevoli



Capri Overview

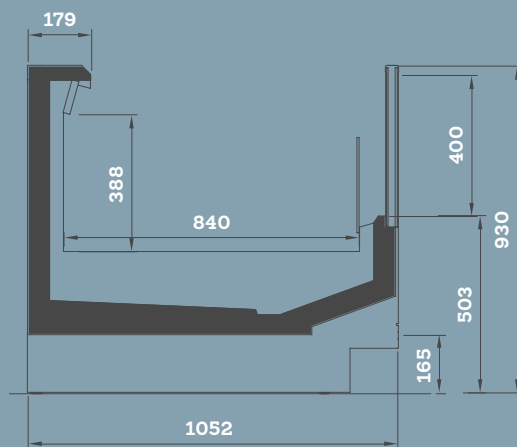

* Complete legend available on product sheets found on our websites www.pastorfrigor.it

COMMERCIAL CATEGORIES*



TECHNICAL FEATURES*



Remote



Ventilated

AVAILABLE DIMENSIONS*

L: 1875 - 2500 - 3750

D: 110

REFRIGERANT*

Thermostatic expansion valve for all the refrigerant in use
Co2 Refrigeration

AVAILABLE VERSIONS*

With sliding doors - Con chiusure scorrevoli



ISLANDS



Sardegna Overview Open

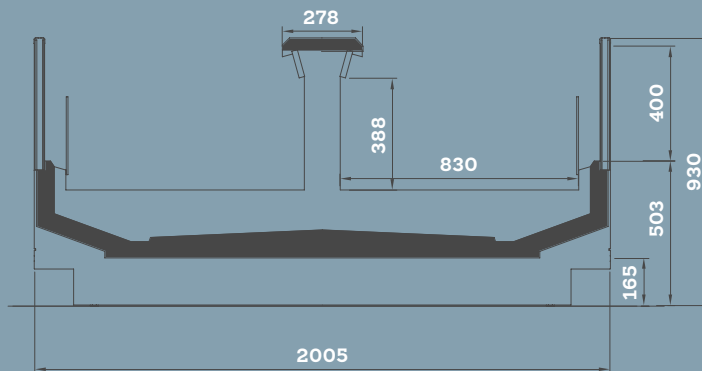

* Complete legend available on product sheets found on our websites www.pastorfrigor.it

COMMERCIAL CATEGORIES*



TECHNICAL FEATURES*



Remote



Ventilated

AVAILABLE DIMENSIONS*

L: 1875 - 2500 - 3750

D: 163 - 204

AVAILABLE VERSIONS*

HG - Front high glass

REFRIGERANT*

Thermostatic expansion valve for all the refrigerant in use
Co2 Refrigeration



ISLANDS



Sardegna Overview Doors

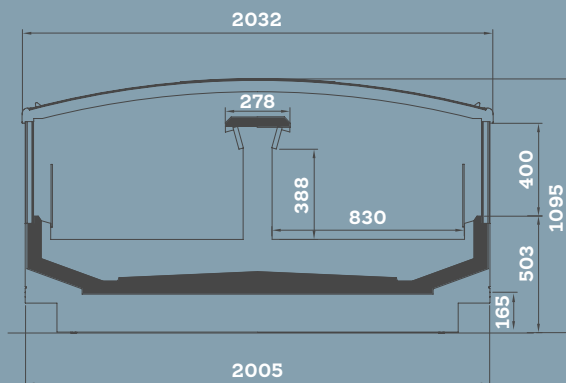

* Complete legend available on product sheets found on our websites www.pastorfrigor.it

COMMERCIAL CATEGORIES*



TECHNICAL FEATURES*



Remote



Ventilated

AVAILABLE DIMENSIONS*

L: 1875 - 2500 - 3750

D: 163 - 204

AVAILABLE VERSIONS*

HG - Front high glass

REFRIGERANT*

Thermostatic expansion valve for all the refrigerant in use
Co2 Refrigeration



Conv

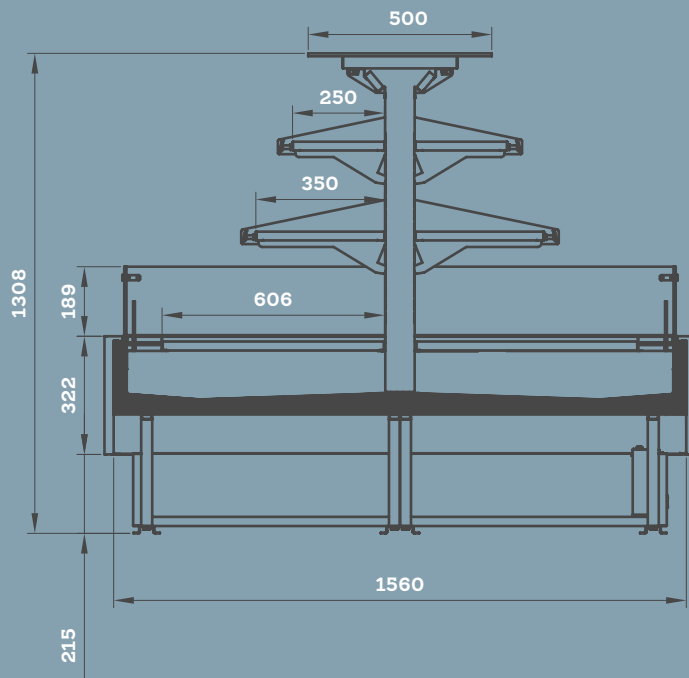

* Complete legend available on product sheets found on our websites www.pastorfrigor.it

COMMERCIAL CATEGORIES*



TECHNICAL FEATURES*



Plug-in



Ventilated

AVAILABLE DIMENSIONS*

L: 1250 - 1875

REFRIGERANT*

Thermostatic expansion valve for all the refrigerant in use



ISLANDS



Felix Q

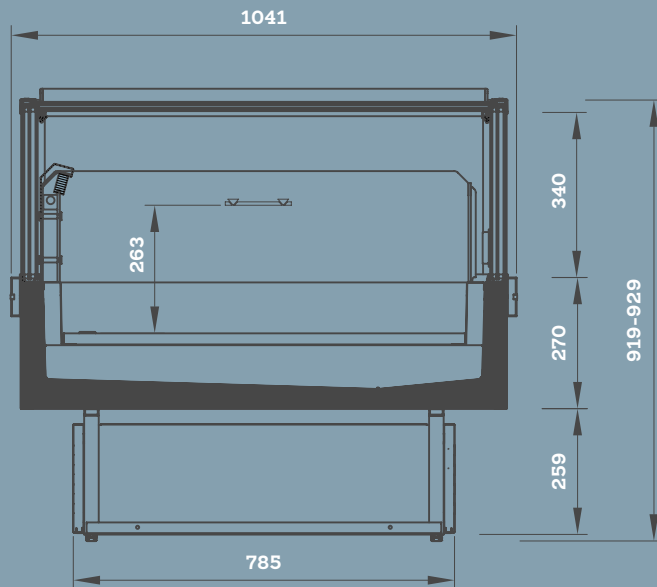

* Complete legend available on product sheets
found on our websites www.pastorfrigor.it

COMMERCIAL CATEGORIES*



TECHNICAL FEATURES*



Plug-in



Ventilated



Propane
refrigerant gas

AVAILABLE DIMENSIONS*

L: 1390 - 1540 - 1990 - 2590

AVAILABLE VERSIONS*

Remote

Led

Dual temperature

REFRIGERANT*

Thermostatic expansion valve
for all the refrigerant in use
R290 built in unit



Felix SG

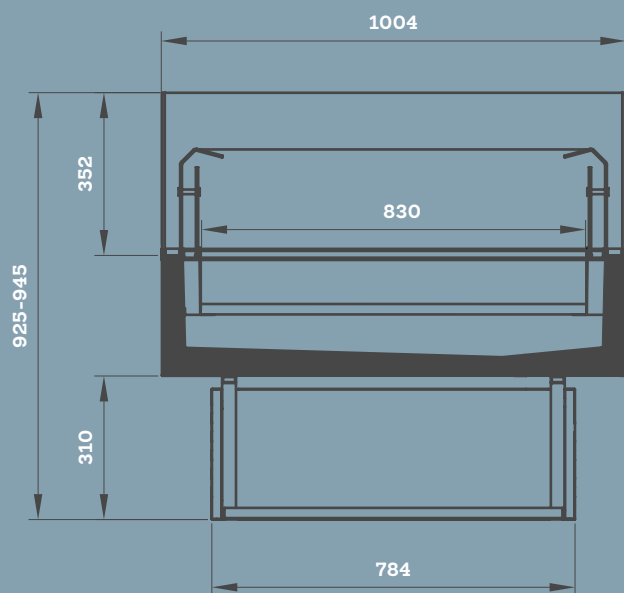

* Complete legend available on product sheets found on our websites www.pastorfrigor.it

COMMERCIAL CATEGORIES*



TECHNICAL FEATURES*



Plug-in



Ventilated

AVAILABLE DIMENSIONS*

L: 1390 - 1540 - 1990 - 2590

REFRIGERANT*

Thermostatic expansion valve for all the refrigerant in use





Cold rooms

CELLE FRIGORIFERE



Cold Rooms

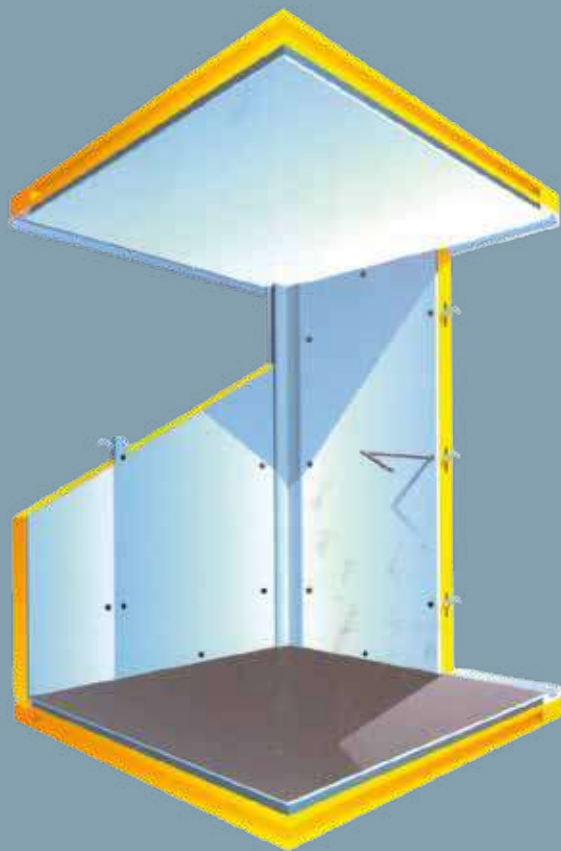

* Complete legend available on product sheets found on our websites www.pastorfrigor.it

COMMERCIAL CATEGORIES*



TECHNICAL FEATURES*

Thickness of the panels:

- from 7 to 10 cm for **Normal temperature**

- from 10 to 13 cm for **Low temperature**

Spessore dei pannelli:

- da 7 a 10 cm per temperatura normale

- da 10 a 13 cm per temperatura negativa

Modularity: dimensions can be increased by 20 cm in width, length and height

Modularità: crescita di 20 cm in 20 cm in larghezza, lunghezza e altezza



Cold Rooms

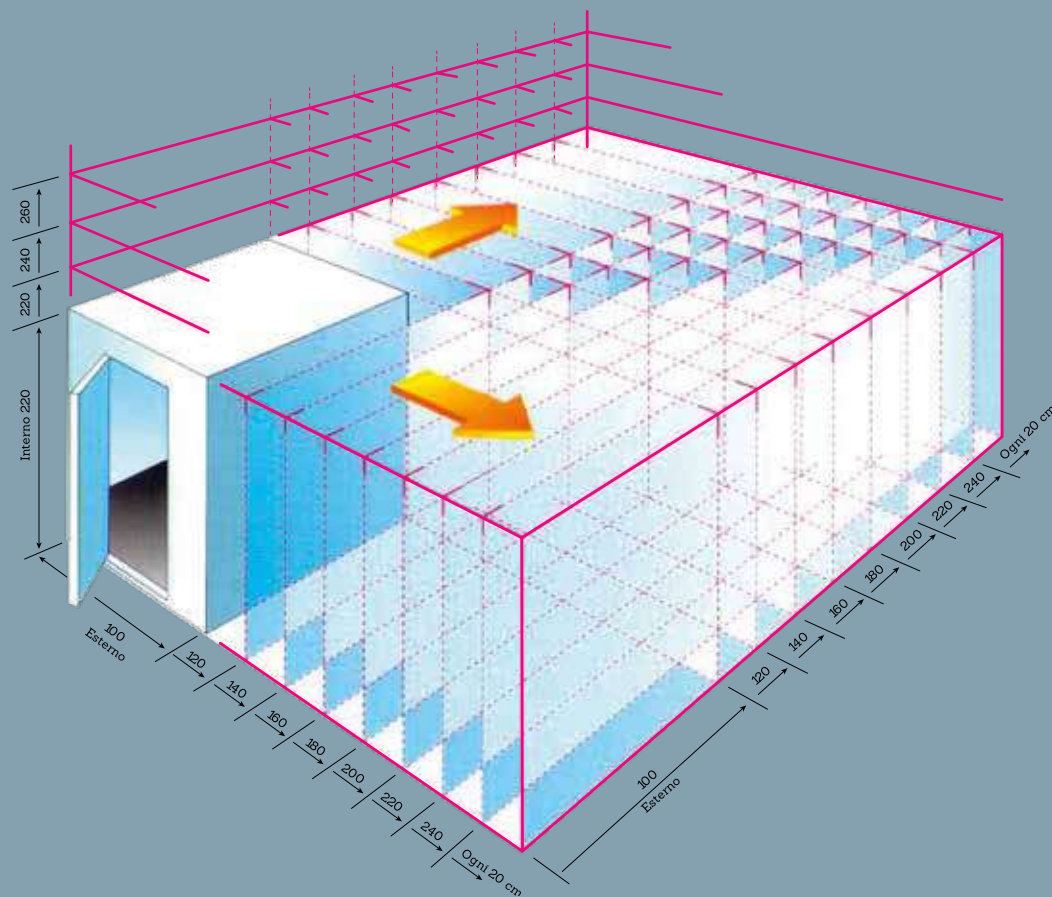

* Complete legend available on product sheets found on our websites www.pastorfrigor.it

COMMERCIAL CATEGORIES*



AVAILABLE VERSIONS*

With or without floor

Con pavimento o senza

Floor can be standard, reinforced and walkable with trolleys

Pavimenti standard, rinforzati o carrellabili

Different types of doors

Diversi tipi di porte

Plasticized, painted or inox externals

Fronti esterni in lamiera plastificata, preverniciata, inox



pastorfrigor
GROUP



Pastorfrigor S.p.A.

Reg. Gabannone, 4 Z.I. · 15033 Terruggia (AL) · Italy | Phone +39 0142 433 711 · Fax +39 0142 433 701 | P.IVA/VAT IT00578270068

www.pastorfrigor.it

BAKERY

BUTCHER CO

1

2

1

4

3

5

6





Typical store with plug in cabinets in R290

Negoziio tipo con mobili a gruppo incorporato R290

1 Rear wall cabinet ROMA, in remote and plug-in version, for cold cuts, cheese and not refrigerated products.

Retrobanco ROMA, gruppo a distanza o plug-in, per salumi, formaggi e prodotti non refrigerati.

2 This is UP the new wall display which you can hang on the wall to show in plain sight the products on sale.

Ecco UP il nuovo espositore che si può appendere alla parete per mettere bene in vista i prodotti in vendita.

3 4 EXCELLENCE for cheese, meat, and deli in remote and plug-in version.

Led are highly performing with low consumption. Joined to EXCELLENCE 45 int. corner.

EXCELLENCE, gruppo a distanza o plug in, per formaggi, carne e gastronomia. Led iper-performanti a basso consumo. Canalizzato a EXCELLENCE ad angolo 45°I.

5 EXCELLENCE BREAD - EXCELLENCE PANE

6 EXCELLENCE cash desk. The design and finishing are matching the rest of the line-up.

EXCELLENCE terminale cassa: le sue finiture ed il design esterno sono allineati con il resto dei banchi a cui è canalizzato.

7 Wall multideck LEM for drinks, snacks, promotional products and more.

Murale LEM per bibite, snack, prodotti promozionali e altro.

8 Multideck freezer GENOVA OVERVIEW BT in the version with 780 mm doors, but also available with small door 625 mm.

Murale per surgelati GENOVA OVERVIEW BT nella versione con porta da 780 mm, ma anche producibile con porta 625 mm.

9 Wall cabinet GENOVA OVERVIEW OPEN for fruit and vegetables.

Murale GENOVA OVERVIEW OPEN per frutta e verdura.

10 The GENOVA OVERVIEW DOORS wall multideck is a very unique product with the lowest energy consumption in the world

Il murale GENOVA OVERVIEW DOORS è un prodotto unico con i consumi più bassi al mondo.

11 PANAREA HD - promotional island for dairy and meat products.

Isola promozionale PANAREA HD per prodotti freschi e carne impacchettata.



Pastorfrigor S.p.A.

Reg. Gabannone, 4 Z.I. · 15033 Terruggia (AL) · Italy

Phone +39 0142 433 711 · Fax +39 0142 433 701

P.IVA/VAT IT00578270068

www.pastorfrigor.it